







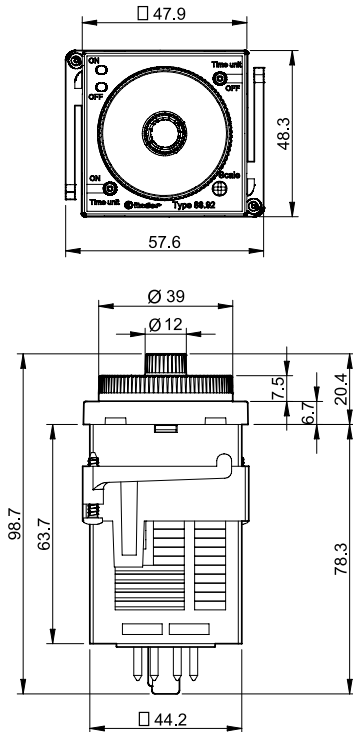
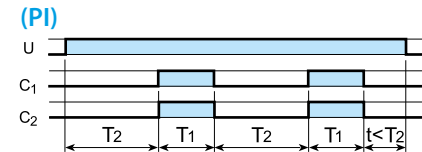
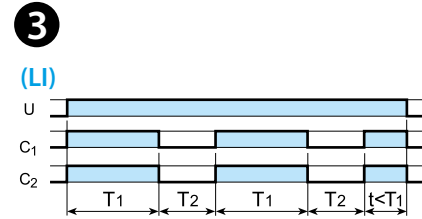
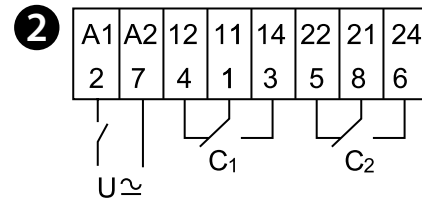
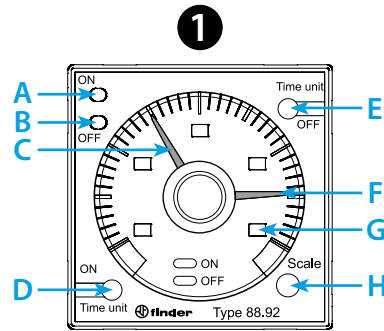

88.92

Utility Model - IB8892001 - 05/19 - Finder S.p.A. con unico socio - 10040 ALMESE (TO) - ITALY

	<b>88.92.0.240.000X</b> U <sub>N</sub> (12...240)V AC (50/60 Hz) / DC U <sub>min</sub> 10.8 V AC / DC U <sub>max</sub> 264 V AC / DC P 2.5 VA (230 V) / 1.5 W (24 V)
	2 CO (DPDT) 8 A 250 V AC  AC1 2000 VA AC15 (230 V AC) 400 VA (M) (230 V AC) 0.3 kW DC1(30/110/220)V (8/0.3/0.12)A
	(-10...+55)°C
IP40	



LED A (ON)	LED B (OFF)	U <sub>N</sub>		
-	-	-	11 - 14 21 - 24	11 - 12 21 - 22
	-	✓	11 - 12 21 - 22	11 - 14 21 - 24
-		✓	11 - 14 21 - 24	11 - 12 21 - 22

H	D - E					
	s	s10	m	m10	h	h10
1.2	1.2 s	12 s	1.2 min	12 min	1.2 h	12 h
3	3 s	30 s	3 min	30 min	3 h	30 h
12	12 s	120 s	12 min	120 min	12 h	120 h
30	30 s	300 s	30 min	300 min	30 h	300 h

88.92

TUJDSCHAKELAR, ASYMMETRISCHE IMPULSGEVER, FRONTMONTAGE OF MONTAGE IN AANSLUITVOET

1 FRONTAANZICHT

- A Rode LED brandt: puls (ON) T1
- B Groene LED brandt: pauze (OFF) T2
- C Rode instelwijzer: T1 tijdinstelling
- D Tijdbereik keuzeschakelaar puls (ON) T1: (s - s10 - m - m10 - h - h10) (\*)
- E Tijdbereik keuzeschakelaar pauze (OFF) T2: (s - s10 - m - m10 - h - h10) (\*)
- F Groene instelwijzer: T2 tijdinstelling
- G Geselecteerde tijd
- H Tijdschaal keuzeschakelaar

2 AANSLUITSCHEMA

3 FUNCTIES

- LI Asymmetrische pulsgever (impuls-beginnend) (88.92.0.240.0001)
- PI Asymmetrische pulsgever (pauze-beginnend) (88.92.0.240.0000)

OPMERKINGEN

- De tijdbereiken (D - E) en tijdschaal (H) moeten voor het aansluiten van de voedingsspanning worden ingesteld
- Tijdbereik: (25 ms...300 h)
- Hersteltijd: 200 ms
- Instelnauwkeurigheid volle schaal: ± 1%
- (\*) s (seconden), s10 (seconden x10), m (minuten), m10 (minuten x10), h (uren), h10 (uren x10)