

## Programmable universal temperature control unit insert with touch display

Operating instructions

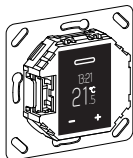

WTH-16  
Art. no. MTN5776-0000

### Necessary accessories

- To be completed with central plate for universal temperature control unit insert with touch display in design System M or System Design.

### Accessories

- MTN5775-0003 Floor Sensor

For operating the thermostat in floor and dual mode.

### For your safety



#### DANGER

**Risk of serious damage to property and personal injury, e.g. from fire or electric shock, due to incorrect electrical installation.**

Safe electrical installation can only be ensured if the person in question can prove basic knowledge in the following areas:

- Connecting to installation networks
- Connecting several electrical devices
- Laying electric cables

These skills and experience are normally only possessed by skilled professionals who are trained in the field of electrical installation technology. If these minimum requirements are not met or are disregarded in any way, you will be solely liable for any damage to property or personal injury.



#### DANGER

**Risk of death from electric shock.**

The outputs may carry an electrical current even when the device is switched off. Always disconnect the fuse in the incoming circuit from the supply before working on connected loads.

### Table of Content

#### Function and installation

- Getting to know the thermostat
- Installing the thermostat

#### Operation

- Displays and operating elements
- Starting up
- Operating the thermostat
- Adjusting the basic settings

#### Appendix

- Behaviour during mains voltage failure and recovery / power reserve
- What should I do if there is a problem?
- Technical data

### Getting to know the thermostat

With the programmable universal temperature control unit insert with touch display (referred to in the following as the **thermostat**), you can regulate the room and/or floor temperature. The unit is operated using a touch display.

The thermostat can be connected to electrical underfloor heating systems, radiators or valve drives which can be switched.

The thermostat has a weekly clock with an individually adjustable program. Alternatively, you can select one of 3 pre-programmed weekly programs. Various heating modes with individual temperature setpoints are available: comfort mode, eco mode and frost protection mode.

### Operating modes

The thermostat can be operated in four different variants.

- **Room air:** The internal temperature sensor detects the room temperature. The thermostat controls this with the aid of the connected heat load.
- **Floor:** The floor sensor detects the floor temperature. The thermostat controls this with the aid of the underfloor heating.
- **Dual:** The internal temperature sensor monitors the room temperature and controls it with the help of the connected heating systems. At the same time, the floor sensor monitors the floor temperature and limits this to the predefined maximum temperature value ("max temp").  
This variant is particularly recommended for temperature-sensitive parquet and laminate floors.
- **PWM:** The pulse width modulator (PWM) switches the heating on and off at regular intervals. In PWM mode, you can adjust the desired temperature using the PWM value (see "Settings the PWM value").  
The floor sensor does not work in this operating mode. The room temperature limits are met.

### External temperature reduction

In all operating modes, you can connect an external switch or time controls for temperature reduction (TR). The internal temperature control is overwritten here.



### Installing the thermostat

#### Installation site of thermostat and floor sensor

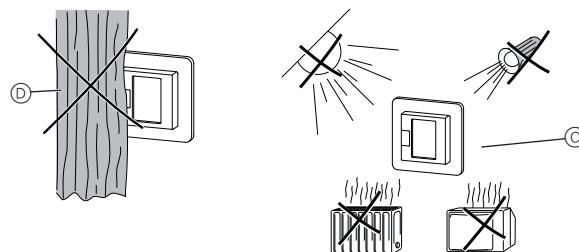
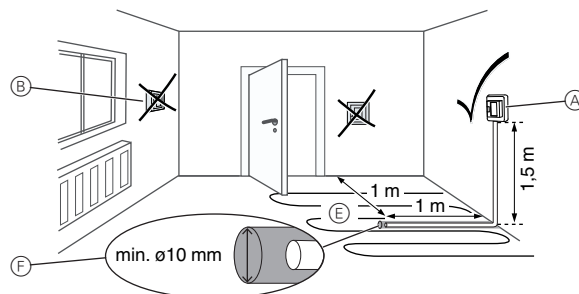

#### Room air mode or dual mode

To ensure reliable thermostat operation, note the following when planning the installation site:

- (A) Minimum installation height: 1.5 m above the floor.
- (B) Do not install too close to windows, doors or ventilation openings.
- (C) Avoid direct sunlight or direct light from lamps.  
Do not install above radiators or other heat sources.
- (D) Do not cover or install behind curtains.

## Floor mode or dual mode

- Ⓔ Position at least 1 m from walls or doors.  
Install in the middle of the loops of the underfloor heating unit (see drawing).
- Ⓕ Lay the floor sensor in a plastic tube with an inside diameter of 10 mm.

## Wire the thermostat

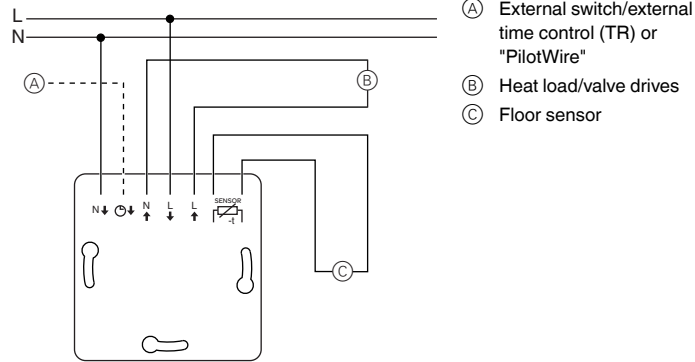

- Ⓐ External switch/external time control (TR) or "PilotWire"
- Ⓑ Heat load/valve drives
- Ⓒ Floor sensor

## Mounting the thermostat and covers

- ① Install the thermostat in a flush-mounted box.
- ② Place the frame onto the insert.
- ③ Press in the snap ring until it presses against the frame.

**i** Selecting a central plate with switches allows you to disconnect both the device and the connected load from the network at both terminals.

**i** Once a central plate without a push-button switch plate has been installed, the thermostat push-button switch Ⓓ is covered and can no longer be actuated. It is therefore important to make sure that the push-button switch Ⓓ has been pressed in (switch position "ON") before install the central plate.

- ④ Press on the central plate until it audibly clicks into place.

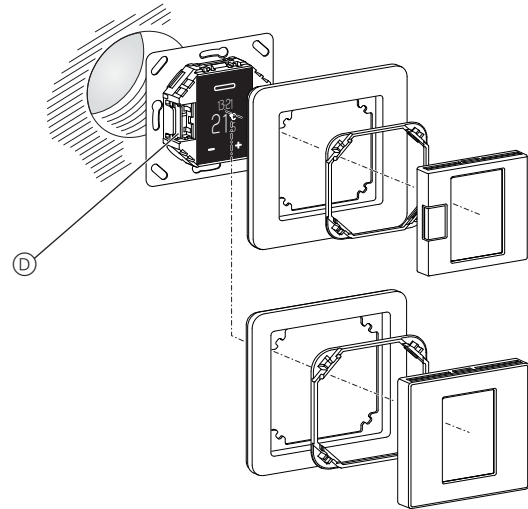

## Removing the covers

- ① Using a suitable screwdriver, press on the marked points to loosen the central plate.

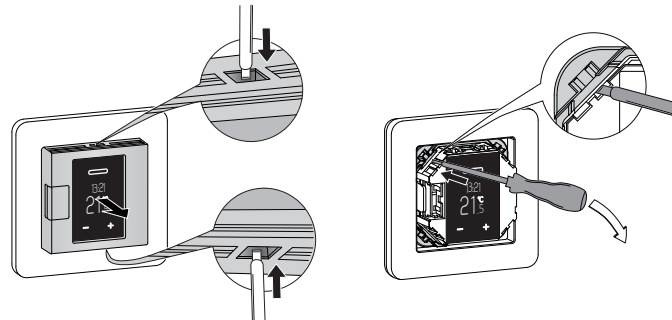

- ② Tilt the central plate forward and remove it.
- ③ Lift out the snap ring using a suitable screwdriver and remove it.
- ④ Remove the frame.

## Displays and operating elements

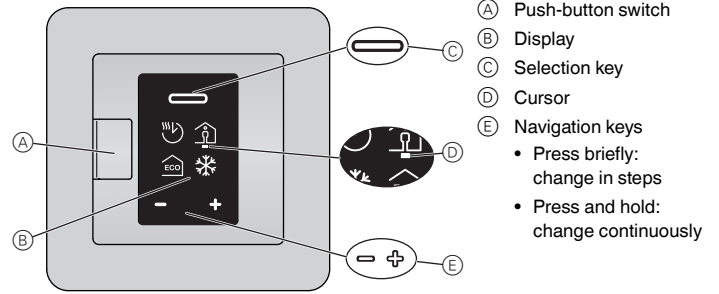

- Ⓐ Push-button switch
- Ⓑ Display
- Ⓒ Selection key
- Ⓓ Cursor
- Ⓔ Navigation keys
  - Press briefly: change in steps
  - Press and hold: change continuously

## Individual display elements

The following symbols are shown on the display, depending on your selections and the navigation level:

Heating mode selection / default	Ⓐ	Ⓑ	Ⓒ	Ⓓ
Ⓐ Auto mode Weekly program that is currently set				
Ⓑ Comfort mode / +21 °C				
Ⓒ Eco mode / +19 °C				
Ⓓ Frost protection mode / +7 °C				
Symbol for manual mode (with hand): setting was selected manually.				
Symbol for external temperature reduction (arrow): temperature is set via TR input.				

Basic settings 1/4 / default	Ⓐ	Ⓑ	Ⓒ	Ⓓ
Ⓐ Date and time / 01.01.2015, 12:00				
Ⓑ Frost protection mode (+5 °C to +21 °C) and eco mode (+5 °C to +50 °C) setpoints				
Ⓒ "Pre-programmed weekly programs" menu				
Ⓓ Display brightness (15% to 100%) / 30% Brightness during standard display				
"Pre-programmed weekly programs" selection				
Ⓐ Freely adjustable weekly programmable				
Ⓑ Work				
Ⓒ Family				
Ⓓ Weekend house				

Basic settings 2/4 / default	Ⓐ	Ⓑ	Ⓒ	Ⓓ
Ⓐ "Room temperature range" menu (PIN lock)				
Ⓑ "Floor temperature range" menu (PIN lock)				
Ⓒ "Calibrate sensor" menu (PIN lock)				
Ⓓ "Operating modes" menu (PIN lock) Red dot on the sensor position indicates the operating mode that is currently selected (here: dual).				
"Temperature" settings				
Ⓐ Minimum and maximum room temperature (+5 °C, +35 °C) / +5 °C, +30 °C				
Ⓑ Minimum and maximum floor temperature (+5 °C, +50 °C) / +5 °C, +40 °C				
Ⓒ Calibrate room air sensor (-3 °C to +3 °C) and floor sensor (-9 °C to +9 °C)				
"Operating modes" selection				
Ⓐ Room air Only internal temperature sensor active				
Ⓑ Floor Only floor sensor active				
Ⓒ Dual Temperature and floor sensors active				
Ⓓ PWM Pulse width modulator: the heating switches on and off at regular intervals.				

### Basic settings 3/4 / default

	(A)	(B)	(C)	(D)
(A) Floor sensor type (PIN lock) Resistance of built-in sensor in ohms at 25 °C: 2 k, 10 k, 12 k, 15 k, 33 k, 47 k				
(B) Valve protection green: activated, white: deactivated				
(C) Relay output (PIN lock) Normally open contact (NO=green), Normally closed contact (NC=green)				
(D) Summer/winter time (CEST) green: activated, white: deactivated				

### Basic settings 4/4 / default

	(A)	(B)
(A) Energy efficiency interval Period for energy efficiency calculation in days / 1 d, 7 d, 30 d		
(B) Exit basic settings		

### Basic settings for operation

	(A)	(B)	(C)
(A) PIN lock Settings require PIN entry (PIN: 5) Applies until you exit basic settings			
(B) Checkbox selected			
(C) Checkbox deselected			

### Faults

	(A)	(B)	(C)
(A) Internal overheating in thermostat (> +85 °C)			
(B) Room temperature sensor not detected.			
(C) Floor temperature sensor not detected.			

All "faults" symbols are yellow.

## Starting up

### Switching on the thermostat for the first time

If the thermostat is connected and the push-button switch is pressed in (D), the start display appears.

Setting the date and time	Touch	Display
(1) Reduce (-) or increase (+) the value marked by the cursor using the navigation keys. Press key briefly: change value in steps Press and hold key: change value continuously		
(2) Confirm the value and switch to the next one with the selection key.		
The settings are saved once you confirm the last value.		

The thermostat starts with the default settings:

- Comfort heating mode
- Room air operating mode

If a floor sensor is connected, it is detected automatically and the floor operating mode is selected. The thermostat then switches to the standard display.

	Also check the following settings:
	• <b>Operating mode:</b> Always set the dual operating mode manually. If the sensor configuration is changed later, the operating mode does not switch automatically and you also have to set this manually.
	• <b>Floor sensor type:</b> Always select the connected floor sensor in the basic settings to ensure correct temperature regulation.
	• All the default settings that are automatically selected when the device is switched on for the first time can be adjusted later on in the "Basic settings" menu.

### Standard display

In the standard display, three different windows appear, changing in rotation every 10 seconds. The current settings and measured values are shown.

The current time is displayed at the top of each window. A red line under the display indicates that the heating is currently active.

(A) <b>Temperature</b> Currently measured temperature	
(B) <b>Energy efficiency information</b> Number of hours of heating during the selected energy efficiency interval	
(C) <b>Heating mode</b> Mode with individual setpoint that currently applies to the heating (here: comfort mode) A hand next to the symbol indicates that the heating mode was selected manually (manual mode) and the heating is not being controlled by a weekly program. This applies until you reactivate auto mode.	

To make the display last as long as possible, it moves slightly every 4 hours (screen saving function).

## Operating the thermostat

### Overview of operation

You can open the menus from each window of the standard display.

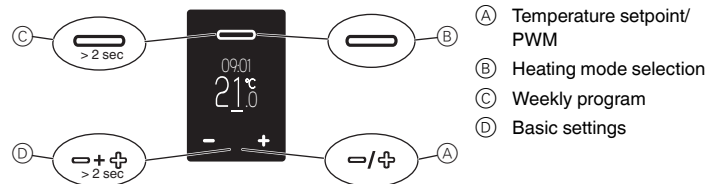

### Setting the temperature for comfort mode

Heating the floor or the room to the desired temperature may take several hours. You should therefore wait a while before increasing the temperature.

Setting the temperature setpoint	Touch	Display
(1) Switch to the temperature setpoint display: Press one of the navigation keys.  The setpoint for the room or floor temperature is shown on the display with green underlining.		
(2) Lower (-) or raise (+) the setpoint in steps of 0.5 K using the navigation keys (room air and dual operating modes from 5 °C to 35 °C, floor operating mode from 5 °C to 50 °C).  The desired setpoint for the room temperature in comfort mode is shown on the display.		
(3) Confirm the new setpoint with the selection key.  The standard display opens. If the measured temperature is lower than the new setpoint, the heating turns on. The display shows red underlining during heating.		

### Setting the PWM value







The pulse width modulator (PWM) switches the heating on and off at regular intervals. In PWM mode, you can adjust the desired temperature using the PWM value. The value is displayed instead of the temperature setpoint, in the same way (see "Setting the temperature setpoint").  
The PWM value specifies the percentage that the heating heats in a recurring interval of 10 minutes.

Example:

- 0%: heating is permanently off
- 50%: heating is on for 5 minutes, then off for 5 minutes
- 100%: heating is permanently on

The thermostat automatically returns to the standard display without saving changes if no entries are made for 15 seconds.

## Selecting the heating mode

	Touch	Display
<p>① Open heating mode selection: Briefly press the selection key.</p> <p>The following four heating modes are displayed (from left to right):</p> <ul style="list-style-type: none"> <li>- Auto mode</li> <li>- Comfort mode</li> <li>- Eco mode</li> <li>- Frost protection mode</li> </ul> <p>The green cursor marks the heating mode that is currently selected (here: auto mode with eco mode programming for the current point in time).</p>		
<p>② Select heating mode: Use the navigation keys to move the cursor to the desired heating mode (here: comfort mode).</p>		
<p>③ Save heating mode and return to standard display: Press the selection key.</p> <p>A hand is displayed in addition to the comfort mode because the mode was selected manually.</p>		

**i** The thermostat automatically returns to the standard display without saving changes if no entries are made for 15 seconds.





**i** If the PWM function is active, heating mode selection is suspended.

## Setting a weekly program



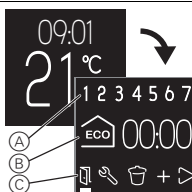

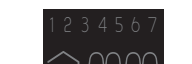
A weekly program is the schedule for heating phases in eco and comfort modes for the entire week. Each switching time for a heating phase is defined for individual days or a group of days.

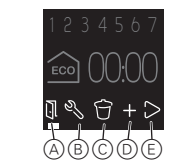
Three pre-programmed weekly programs are available (see "Possible settings/pre-programmed weekly programs") and you can change these temporarily. Your settings are only retained until you select another weekly program. In addition, you can create a freely adjustable weekly program of your own to meet your needs. During commissioning, the freely adjustable weekly program is selected but no heating phases are stored.







### Navigating the weekly program

	Touch	Display
<p>① Open "Weekly program" menu: Press and hold the selection key on the standard display.</p> <p>The information for a saved heating phase of the active weekly program is shown on the display (here: not heating phase stored).</p> <p><b>Information per line:</b></p> <ul style="list-style-type: none"> <li>(A) Days of the week (Mon-Sun = 1-7) green: activated, red: deactivated</li> <li>(B) Heating mode and switching time</li> <li>(C) Operating menu</li> </ul>		
<p>② Select desired function: Use the navigation keys to move the cursor to the desired function.</p>		
<p>③ Activate selected function: Press the selection key.</p> <p><b>Functions:</b></p> <ul style="list-style-type: none"> <li>(A) Exit menu</li> <li>(B) Change heating phase</li> <li>(C) Delete heating phase</li> <li>(D) Add new heating phase</li> <li>(E) Scroll between heating phases</li> </ul>		







### Creating a new heating phase

	Touch	Display
<p>① Add new heating phase: Select and activate the function "Add heating phase" (D).</p> <p>The heating phase settings display opens.</p>		
<p>② Make settings (see "Editing settings")</p>		





### Change heating phase

	Touch	Display
<p>① Select heating phase: Use the "scroll" (E) function to select the heating phase that you want to change (see "Navigating the weekly program").</p>		
<p>② Open settings for heating phase: Select and activate the function "Change heating phase" (B).</p> <p>The heating phase settings display opens.</p>		
<p>③ Change settings (see "Editing settings")</p>		





### Editing settings

	Touch	Display
<p>① Activate days of the week: Deactivate (-) or activate (+) the days on which the heating phase runs (green/in bold here) or does not run (red) and confirm your entries with the selection key.</p> <p>The cursor moves to the next day of the week when you press a navigation key and goes to the switching time if you then confirm this with the selection key.</p>		
<p>② Change switching time: Increase (+) or reduce (-) the hours in steps of one and the minutes in steps of ten. Confirm each entry with the selection key.</p> <p>After the first confirmation, the cursor moves to the minute display and after the second confirmation, it moves to the heating mode line.</p>		
<p>③ Set heating mode: Change the active heating mode (green) with the navigation keys and confirm your choice with the selection key.</p> <p>The settings are saved. The "Weekly program" menu appears again.</p>		

### Delete heating phase

	Touch	Display
<p>① Select heating phase: Use the "scroll" (E) function to select the heating phase that you want to delete (see "Navigating the weekly program").</p>		
<p>② Delete heating phase: Select and activate the function "Delete heating phase" (C).</p> <p>The next saved heating phase is displayed.</p>		

### Exit menu

	Touch	Display
<p>① Select and activate the function "Exit menu" (A).</p> <p>The standard display opens.</p>		
		

**i** The thermostat automatically returns to the standard display without saving changes if no entries are made for one minute.

## Adjusting the basic settings

### Navigating in the basic settings

#### Selecting a possible setting

① Open basic settings:  
Press and hold both navigation keys together.  
The first of four pages is displayed. The green cursor marks the first possible "date/time" setting on the first page.

② Select basic settings page:  
Starting from the bottom/right icon, open the next page with the (+) navigation key.

Or

Starting from the top/left icon, open the previous page with the (-) navigation key.

**Basic settings pages** (possible settings from left to right):

- Ⓐ Date/time, heating mode setpoints, pre-programmed weekly programs, display brightness
- Ⓑ Room temperature range, floor temperature range, calibrate sensor, operating modes
- Ⓒ Floor sensor type, valve protection, relay output, summer/winter time (CEST)
- Ⓓ Energy efficiency interval, exit

③ Open possible setting:  
Use the navigation keys to move the cursor to the desired possible setting.  
Confirm your choice with the selection key.

#### With PIN entry Ⓔ:

Some possible settings are protected by PIN entry for safety reasons. The authorisation remains valid until you exit the basic settings.

Enter the PIN (5) using the navigation keys.  
Confirm your entry with the selection key.

Or

#### Without PIN entry Ⓕ:

You do not have to enter a PIN for standard settings.

The setting window is displayed.

Touch	Display
⇐/+ > 2 s	
+	
-	
⇐/+	
⇐/+	
⇐/+	
⇐/+	

#### Exit menu

- ① Go to the last page of the basic settings 4/4 and select the "exit" symbol with the cursor.
- ② Press the selection key to return to the standard display.

Touch	Display
⇐/+	
⇐/+	

### Adjusting the basic settings

Depending on the possible setting, you can change values, select icons or select icons and change the corresponding values.

#### Changing values

Date/time (example)

- ① Reduce (-) or increase (+) a value with the navigation keys.
- ② Confirm the value and switch to the next one with the selection key.

When you confirm the last value, the settings are saved. The display switches to the current basic settings page.

Touch	Display
⇐/+	
⇐/+	

#### Selecting an icon

Pre-programmed weekly programs (example)

- ① Select weekly program:  
Use the navigation keys to move the cursor to the desired weekly program.
- ② Confirm your choice with the selection key.  
The current page of the basic settings is displayed.

Touch	Display
⇐/+	
⇐/+	
⇐/+	
⇐/+	

#### Selecting an icon and changing the value

Heating mode setpoints (example)

The cursor marks the first symbol (here: frost protection mode).

- ① Change the corresponding value with the navigation keys.
- ② Confirm the value and switch to the next symbol (here: eco mode) with the selection key.

When you confirm the last value, the settings are saved. The display switches to the current basic settings page.

Touch	Display
⇐/+	
⇐/+	
⇐/+	
⇐/+	

**i** The thermostat automatically returns to the standard display without saving changes if no entries are made for one minute.

### Setting options

#### Basic settings 1/4

- Ⓐ Date/time
- Ⓑ Setpoints for frost protection and eco mode
- Ⓒ Pre-programmed weekly programs (see "Weekly program curve")  
You can choose between three default weekly programs. The default programs are useful for efficient heating with different alternative uses. They can be changed but not permanently overwritten. The next time you select them, the previous changes are discarded. In addition, you can also configure your own weekly program and select that. This is retained permanently even when you change programs.
- Ⓓ Display brightness

- Ⓓ Display brightness  
You can adjust the brightness of the display. When you make settings, the display always switches to its maximum brightness (100%). Changes to the brightness are active after about one minute.

**i** Reduced brightness improves the display's service life.

#### Weekly program curve

The diagrams show the temperature curve over the course of a day:

- Ⓐ Temperature
- Ⓑ Time in hours or days (Monday to Sunday = 1-7)
- Ⓒ Temperature curve at weekend (dotted line)
- Ⓓ Temperature curve on workdays (solid line)
- Ⓔ Raise temperature (optimum start)
- Ⓕ Lower temperature

The higher setpoint temperature is reached by the set time. Heating begins in advance. The thermostat automatically learns the time needed to heat up.

- Ⓕ Lower temperature  
The temperature is reduced at the set time until it reaches the lower setpoint temperature after the cooling down time.

#### Freely adjustable weekly programmable:

Use the comfort and eco modes to set a temperature curve to match your needs.

Example:

The heating runs in eco mode at night and in comfort mode during the day. On workdays, the comfort setpoint temperature is reached at 6 am and is lowered again after 10 pm. At the weekend, comfort mode is used for the heating between 8 am and midnight.

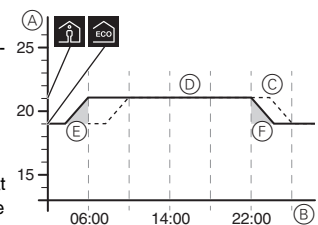

### Work weekly program:

The heating runs in eco mode at night. In the morning, the temperature is raised to the comfort mode setpoint temperature so that it is reached by 6 am (optimum start). At 8 am, the temperature is lowered to the eco mode setpoint. From 5 pm to 10 pm, the heating returns to comfort mode.

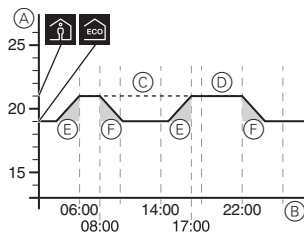

### Family weekly program:

The heating runs in comfort mode each day between 6 am and 10 pm and in eco mode at night.

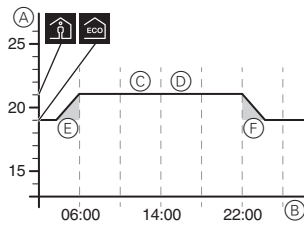

### Weekend house weekly program:

At the weekend (Friday 5 pm to Sunday 10 pm), the heating runs in comfort mode and it runs in eco mode on workdays (Sunday 10 pm to Friday 5 pm).

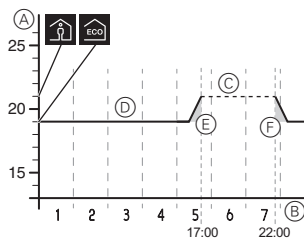

### Basic settings 2/4

- (A) Room temperature range (PIN lock)
- (B) Floor temperature range (PIN lock)
- (C) Calibrate sensor  
You can correct the measured room and floor temperatures up or down.
- (D) Operating modes (PIN lock)  
After the initial automatic configuration, all changes to the operating mode have to be done manually. The dual mode and PWM operating modes always have to be set manually.

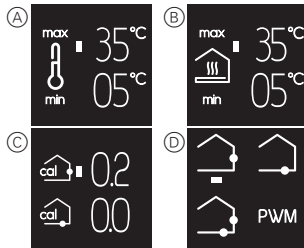

### Basic settings 3/4

- (A) Floor sensor type (PIN lock)  
Select the resistance (at 25 °C) for the connected sensor. The value is displayed in the menu. An incorrectly selected sensor will not regulate the temperature properly. The actual temperature may exceed the maximum set temperature and may cause damage to the floor covering.
- (B) Valve protection (protects against valve sticking)  
The valve is completely extended for 4 minutes once a week on Tuesdays at 10 am. Activate valve protection with "checkbox selected". The symbol is displayed in green in the menu.
- (C) Change relay output (PIN lock)  
Choose between a normally open (NO) or a normally closed (NC) contact. The selection is displayed in green in the menu.
- (D) Summer/winter time (CEST)  
Activate the automatic toggling between Central European summer and winter time with "checkbox selected". The symbol is displayed in green in the menu.

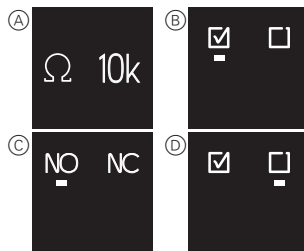

### Basic settings 4/4

Energy efficiency interval (monitoring period)

The hours of heating are added up for each time interval as an indication of the energy used for heating. You can choose a time interval of 1, 7 or 30 days.

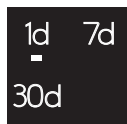

### Behaviour during mains voltage failure and recovery / power reserve

In the event of mains voltage failure the display goes out. The current thermostat settings are saved either permanently, temporarily for two days or not at all:

- Saved permanently: temperature setpoint in comfort mode, manual mode selection, weekly programming, all basic settings,
  - Saved temporarily: date/time,
  - Not saved: energy efficiency counter
- After mains voltage recovery the next switching time in the weekly program is carried out first.

### What should I do if there is a problem?

#### Connected load is not heating

- If using an external time control device, check the control voltage.
- Check power supply and connections.
- Switch thermostat off and back on again.
- Check setting for maximum temperature. The value may be too low.

#### Error messages

##### Internal overheating in thermostat (> +85 °C)

- Check load limits and connections.



##### Room temperature sensor not detected

- The internal sensor in the thermostat may be defective. The thermostat has to be replaced by the electrical installer.



##### Floor temperature sensor not detected

- Check operating mode selection.
- Check sensor installation. The floor sensor is not connected, defective or it has short-circuited. The electrical installer has to connect the sensor correctly or replace it.



##### Correct fault (error message disappears)

- Setting incorrect: Exit the error message by pressing any key. The standard display opens. Correct the settings in the basic settings.
- Hardware fault: contact an electrical installer.

#### Display blank

- Check the power supply.
- Switch thermostat off and back on again.  
If using a central plate without a push-button switch plate, check the state of the pressure plate under the central plate.

### Technical data

Nominal voltage:	230 V AC, 50 Hz
Nominal voltage at external input (TR):	230 V AC
Nominal load (ohmic):	3680 W (~16 A) (cos φ = 1)
Nominal load (inductive):	1 A, cos φ = 0.6
Mode of operation:	1 C
Type of housing protection:	IP 20
Surge protection/overheating protection:	Electronic
Rated surge voltage:	4 kV
Operating temperature:	-10 °C to +35 °C
Setting range	
Room temperature:	+5 °C to +35 °C
Floor temperature:	+5 °C to +50 °C
Display precision:	0.5 °C
Connecting terminals:	max. 1 x 2.5 mm <sup>2</sup> or 2 x 1.5 mm <sup>2</sup>
Room sensor calibration:	-3 °C to +3 °C
Floor sensor calibration:	-9 °C to +9 °C
Operation with external sensors at 25 °C:	NTC 2 k, 10 k, 12 k, 15 k, 33 k, 47 k

### Schneider Electric Industries SAS

If you have technical questions, please contact the Customer Care Centre in your country.  
www.schneider-electric.com