

# FERINA

WOJP00409



Power **19 W**  
Colour temperature **3000 K**  
Beam angle **24 °**

Voltage **230 V**  
Colour of light **WW**  
Degree of protection (IP) **IP20**

## Technical data

Code	WQJP00409
Power	19 W
Nominal current	90.9 mA
Voltage	230 V
Energy consumption	19 kWh/1000h
Frequency	50HZ Hz
Protection class	I
Power supply included	+
Manufacturer of power supply	TCI
Power factor	0.93
Useful luminous flux*	2660 lm (360°)
Luminous flux**	2090 lm (360°)
Lamp efficacy	140 lm/W
Colour temperature	3000 K
Colour of light	WW
Beam angle	24 °
RA	80
Light source included	+
Producer of LED diodes	CREE
Uniformity of color SDCM max	3
Dimmable	No
Working temperature range	-20/+40 °
Lifespan	50000 h
Housing material	Aluminum
Degree of protection (IP)	IP20
Colour	White
Dimension (AxBxC)	130x220x245 mm
For use	Inside
Assembly method	on track
Application	Inside
Made in	PL

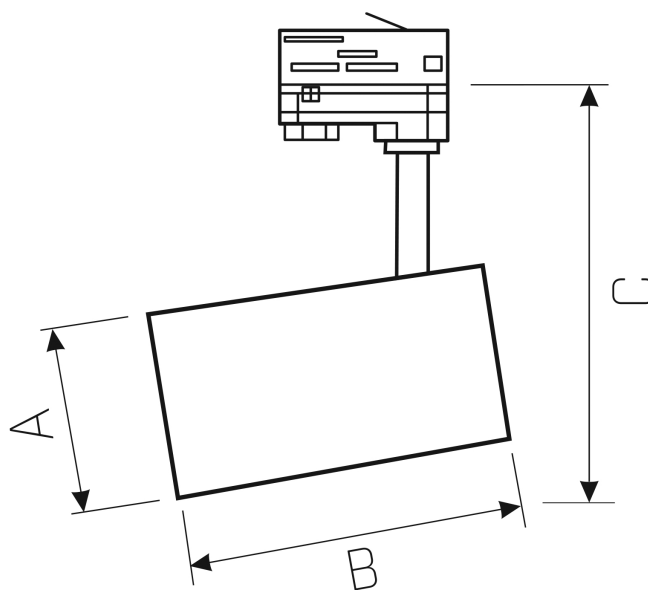

## Related documents



 Declaration of Conformity



 Photometric file