

Weitergabe sowie Vervielfältigung dieses Dokuments, Verwertung und Mitteilung seines Inhalts sind verboten, soweit nicht ausdrücklich gestattet. Zuwiderhandlungen verpflichten zu Schadensersatz. Alle Rechte für den Fall der Patent-, Gebrauchsmuster- oder Designeintragung vorbehalten. Bauartbedingtes Spiel ist in den Toleranzangaben nicht berücksichtigt.

Transfer or duplication of this document as well as the utilisation or communication of its content are not permitted unless express consent is granted. Violations give rise to claims for damages. All rights reserved in case of patent, utility model or design patent registrations. Tolerance specifications do not include clearances inherent in the design.

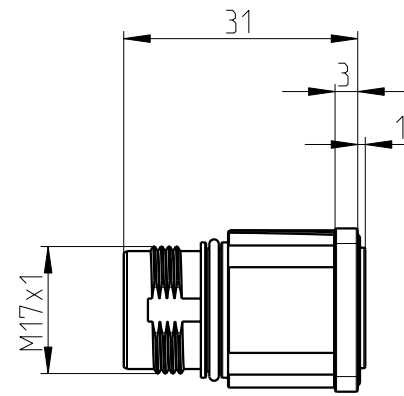

socket face female

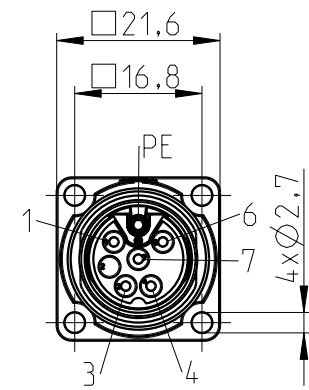

delivering status

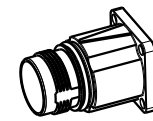

1:2

	document-No. / RI	date	scale	- Simplified representation - Document excluded from change process - Linear dimensions [mm] - EN ISO 291 23/50
	097037983 /00	15.10.19	1:1	
	document-type	description		
	TECDCO 2D-PRODUCTFAMILY	ST-5ESIN8AW400S		
page 1	of 1			