

Electronic Thermostat E5L

Ideal for Simple Built-in Control.

- A high switching capacity of 10 A at 250 VAC enables direct load switching.
- A sensor is provided to enable immediate application.
- Sockets with finger protection (PTF14A-E), without finger protection (PTF14A) and Socket with Push-In Plus technology (PTF-14-PU-L) can be used.
- Simple operation and settings. Even simpler with digital models.



Model Number Structure

Model Number Legend

E5L-□□
1 2

- | | |
|-----------------------------------|--------------------------|
| 1. Setting and Indication Methods | 2. Set temperature |
| A: Analog setting, no display | -30-20 : -30 to +20°C |
| C: Digital setting, display | 0-50 : 0 to +50°C |
| | 0-100 : 0 to +100°C |
| | 100-200 : +100 to +200°C |

Ordering Information

Electronic Thermostats

E5L-A□

Size	Type	Control method	Control output	Model
45 × 35 mm	Plug-in	ON/OFF operation	Relay	E5L-A -30-20
				E5L-A 0-50
				E5L-A 0-100
				E5L-A 100-200

E5L-C□

Size	Type	Control method	Control output	Model
45 × 35 mm	Plug-in	ON/OFF operation	Relay	E5L-C -30-20
				E5L-C 0-100
				E5L-C 100-200

Note: The E5L-C is not available with a set temperature range of 0 to 50°C.

Options (Order Separately)

Mounting Brackets

Model
Y92H-10

Note: This Mounting Brackets is provided with the Electronic Thermostat.

Sockets

Type	Model
Front-connecting Socket	PTF14A
	PTF14A-E
	PTF-14-PU-L

E5L

Ratings and Characteristics

Ratings

Item	Model	E5L-A□	E5L-C□
Power supply voltage		100 to 240 VAC, 50/60 Hz	
Operating voltage range		85% to 110% of the rated supply voltage	
Power consumption		Approx. 3 VA	
Inputs		Element-interchangeable thermistor	
Control method		ON/OFF control	
Control output		SPDT contacts, 250 VAC, 10 A, $\cos\phi = 1$ (resistive load)	SPST-NO contacts, 250 VAC, 10 A, $\cos\phi = 1$ (resistive load)
Setting method		Analog setting	Digital settings using keys on front panel
Indication method		No display	LCD digital display (character height: 12 mm)
Other functions			<ul style="list-style-type: none"> • Setting protection (key protection) • Input shift • Direct/reverse operation
Ambient temperature		-10 to 55°C (with no icing or condensation)	
Ambient humidity		25% to 85%	
Storage temperature		-25°C to 65°C (with no icing or condensation)	

Note: Do not use the output from an Inverter as the power supply.

Characteristics

Item	Model	E5L-A□	E5L-C□
Indication accuracy		---	$\pm(1^\circ\text{C} + 1 \text{ digit}) \text{ max.}^{*1}$
Setting accuracy		---	$\pm(1^\circ\text{C} + 1 \text{ digit}) \text{ max.}^{*1}$
Hysteresis		-30 to 20°C models: Approx. 0.5 to 2.5°C (variable) 0 to 50°C models: Approx. 0.5 to 4°C (variable) 0 to 100°C models: Approx. 0.5 to 4°C (variable) 100 to 200°C models: Approx. 0.7 to 4°C (variable)	1 to 9°C (in increments of 1°C)
Repeat accuracy		1% FS max.	---
Minimum scale (standard scale)		-30 to 20°C models and 0 to 50°C models: 5°C 0 to 100°C models and 100 to 200°C models: 10°C	---
Influence of temperature		---	$\pm((1\% \text{ of PV or } 2^\circ\text{C, whichever is greater}) + 1 \text{ digit}) \text{ max.}$
Influence of voltage		---	
Influence of EMS. (at EN61326-1)		---	
Sampling period		---	2 s
Insulation resistance		100 M Ω max. (at 500 VDC)	
Dielectric strength		2,810 VAC, 50/60 Hz for 1 min (between charged terminals and uncharged metallic parts, between power supply terminals and input terminals, between power supply terminals and output terminals, and between input terminals and output terminals)	
Vibration (malfunction)		Frequency of 10 to 55 Hz, 0.5-mm double amplitude for 10 min each in X, Y, and Z directions	
Vibration (destruction)		Frequency of 10 to 55-Hz, 0.75-mm double amplitude for 2 h each in X, Y, and Z directions	
Shock (malfunction)		150 m/s ² , 3 times each in 6 directions	100 m/s ² , 3 times each in 6 directions
Shock (destruction)		300 m/s ² , 3 times each in 6 directions	
Electrical life expectancy (control output relay)		100,000 operations min (at maximum applicable load)	
Memory protection		---	Non-volatile memory (100,000 write operations)
Weight (Thermostat)		Approx. 80 g (Thermostat only)	
Degree of protection		Front panel: IP40, Terminals: IP00	
Approved standards		---	
Conformed standards		EN 61010-1 (IEC 61010-1), Pollution Degree 2, Overvoltage Category II	
EMC Directives		EMI: Radiated EMI: Conducted EMI: EMS: Electrostatic discharge immunity: Electromagnetic field strength immunity: Burst noise immunity: Conducted disturbance immunity: Surge immunity: Voltage dip and power interruption immunity:	EN61326-1*2 EN55011 Group1 ClassA EN55011 Group1 ClassA EN61326-1*2 EN61000-4-2 EN61000-4-3 EN61000-4-4 EN61000-4-6 EN61000-4-5 EN6100-4-11

*1. The accuracy of the accessory thermistor is not included.

*2. Industrial electromagnetic environment (EN/IEC 61326-1 Table 2)

External Connections

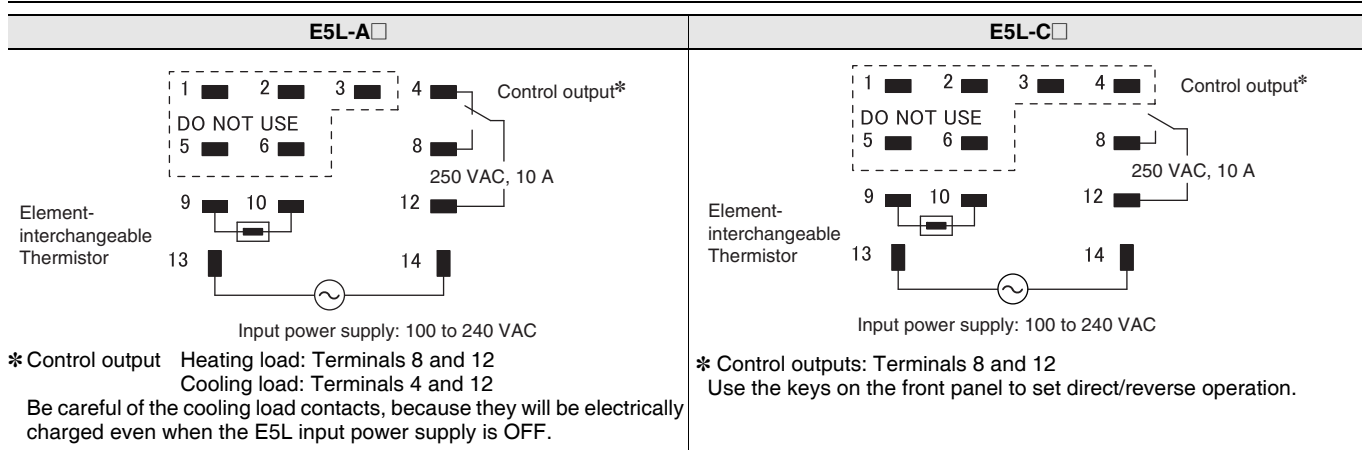

Note: For thermistor wiring, separate the input power supply and load lines as much as possible to avoid the influence of inductive noise.

Nomenclature

E5L-A□



Operation Indicator

Operation indicator	Output status	
	Heating load	Cooling load
Lit red.	ON	OFF
Not lit.	OFF	ON

E5L-C□

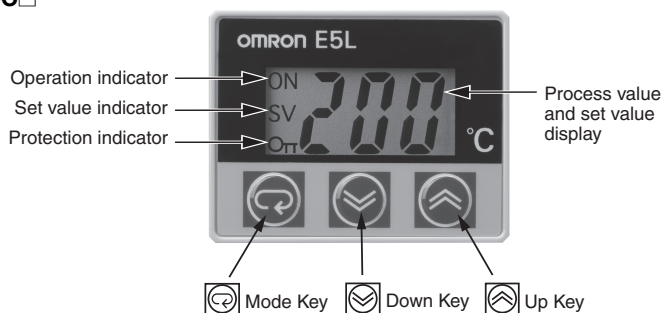

Operation Indicator: ON

Operation indicator	Output status	
	Reverse operation	Direct operation
Lit	ON	ON
Not lit	OFF	OFF

Set Value Indicator: SV

Lit when the set value is displayed.

Setting Protection Indicator: OT

Lit when setting protection is set.

E5L

Dimensions

(Unit: mm)

Thermostats

E5L-A

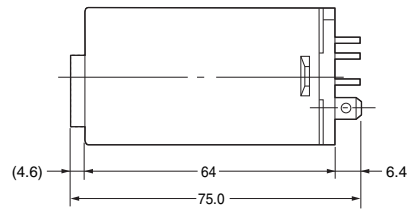
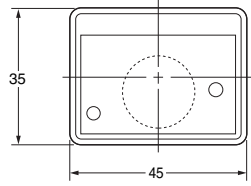

E5L-C

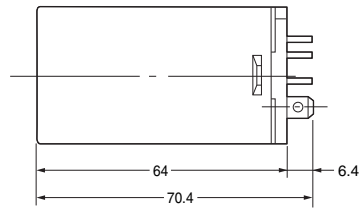
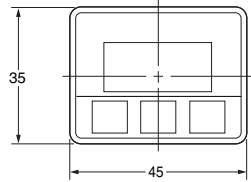

Wiring Connection Sockets (Order Separately)

Dimensions		Terminal Arrangement and Internal Connections	Mounting Hole Dimensions
<p>PTF14A</p>	<p>PTF14A-E Socket with Finger Protection</p>	<p>(TOP VIEW)</p>	<p>(TOP VIEW)</p> <p>Note: Can be mounted to a DIN Track.</p>
<p>PTF-14-PU-L Socket with Push-In Plus technology</p>	<p>(TOP VIEW)</p> <p>Note: The numbers in parentheses are traditionally used terminal numbers.</p>	<p>(TOP VIEW)</p> <p>Two, M3 screw hole or two, 3.5 dia. hole</p> <p>Note: Pull out the hooks to mount the Relay with screws.</p>	

Accessories

E52-THE-E5L Element-interchangeable Thermistor

Included with the following models: -30 to 20°C .

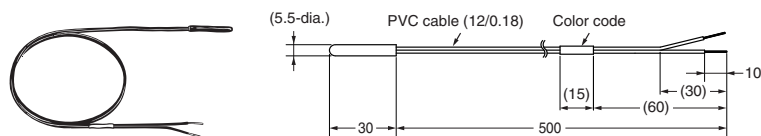

Included with the following models: 0 to 50°C and 0 to 100°C .

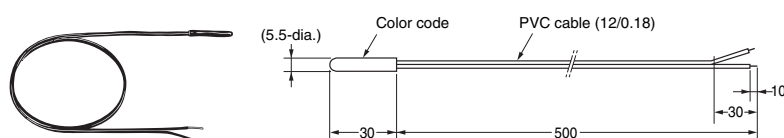

Included with 100 to 200°C Models.

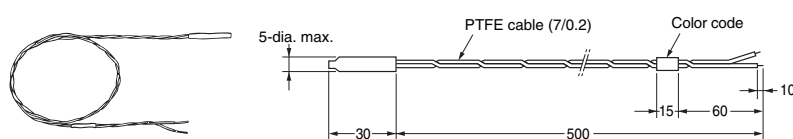

Temperature Range

Temperature range	Color code	Nominal resistance	Thermistor constant	Lead wires
-30 to 20°C	Blue	$6\text{ k}\Omega$ (0°C)	$3,390\text{ K}$	Heat-resistant PVC cable
0 to 100°C *	Black	$6\text{ k}\Omega$ (0°C)	$3,390\text{ K}$	PVC cable
100 to 200°C	Yellow	$0.55\text{ k}\Omega$ (200°C)	$4,300\text{ K}$	PTFE

Note: PVC cable is heat resistant from -40 to 105°C .
PTFE cable is heat resistant from -40 to 250°C .
* Use a 0 to 100°C thermistor for 0 to 50°C applications.

Tolerance

Measured temperature	Tolerance
-30 to 100°C	$\pm 2^{\circ}\text{C}$ max.
100 to 200°C	Measured temperature $\pm 2\%$ max.

Y92H-10 Mounting Brackets (Two)

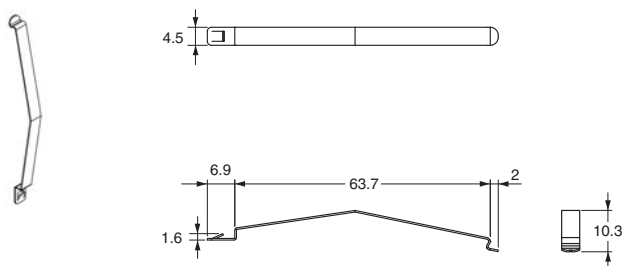

Note: Included with product.
If a mounting bracket is missing or damaged, order a new bracket separately.

Temperature Sensors (Order Separately)

E52-THE5A, E52-THE6D, and E52-THE6F Temperature Sensors can be ordered separately. For details, refer to an *OMRON Web site*.

Operating the E5L-C□

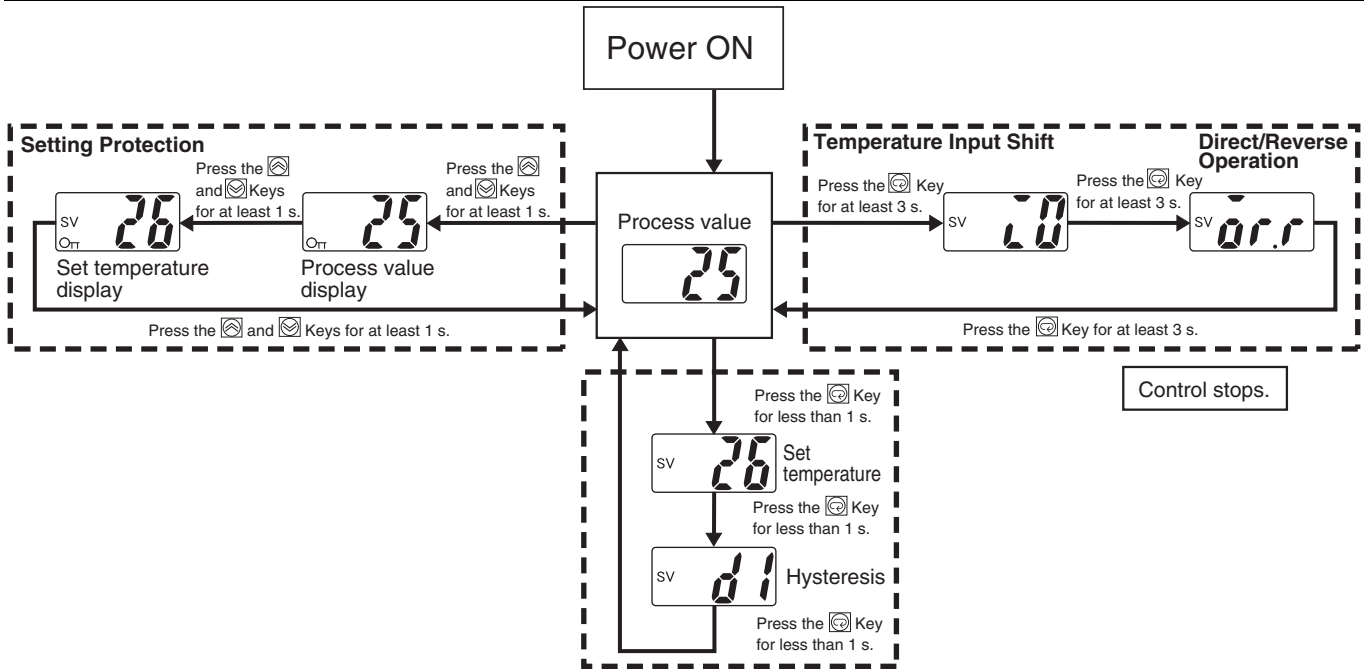

Set temperature

1. Press the [F] Key to enter the Set Temperature Mode.
 2. Press the [F] and [M] Keys to set the temperature. The display will continue to change for as long as the key is held down.
- Note:** The default setting is the lowest temperature in the range.

Setting the Hysteresis

1. Press the [F] Key to enter the Hysteresis Mode.
 2. Press the [F] and [M] Keys to set the value. Each time the key is pressed, the setting will change by 1°C. The setting will not continue to change even if the key is held down. The key must be released after each change. The hysteresis can be set from 1 to 9°C, in increments of 1°C.
- Note:** The default setting is 1°C.

Hysteresis	Display
+1°C	SV d1
+5°C	SV d5
+9°C	SV d9

Reverse Operation (Heating Control) Direct Operation (Cooling Control)

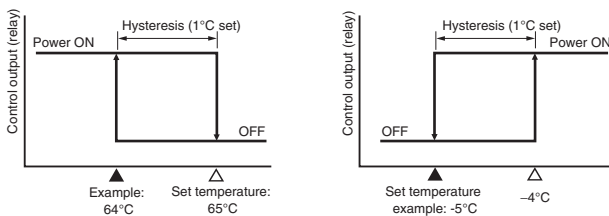

Setting the Temperature Input Shift

1. Press the [F] Key for at least 3 s to enter the Temperature Input Shift Mode.
 2. Press the [F] and [M] Keys to set the value. Each time the key is pressed, the setting will change by 1°C. The setting will not continue to change as the key is held down. The key must be released after each change. The input shift can be set from -9 to 9°C, in increments of 1°C.
- Note:** 1. The default setting is 0°C.
2. The control output turns OFF while this setting is being made.







Input shift display	Thermistor measured temperature	Temperature display
SV 20 (No shift)	25°C	25°C
SV 29 (+9°C shift)	25°C	34°C
SV -29 (-9°C shift)	25°C	16°C

Setting Direct or Reverse Operation

1. Press the [F] Key for at least 3 s to enter the Direct/Reverse Selection Mode.
 2. Press the [F] and [M] Keys to set the value. Direct operation can be set by pressing the [F] Key, and reverse operation can be set by pressing the [M] Key.
- Note:** 1. The default setting is for reverse operation.
2. The control output turns OFF while this setting is being made.

Direct/reverse operation	Display
Reverse operation	SV or.r
Direct operation	SV or.d

Setting Protection

1. Setting Protection (Process Value Display)
Press the  and  Keys simultaneously while the process value is being displayed to change to the setting protection state.
2. Setting Protection (Set Temperature Display)
From the Setting Protection (process value display) Mode, press the  and  Keys simultaneously to change to the setting protection (set temperature display) state.
3. From the Setting Protection (set temperature display) Mode, press the  and  Keys simultaneously to return to the process value display with no setting protection.

Display example	Display
Process value display	ON O _{TT} 25
Set temperature display	ON SV O _{TT} 25

- Note:**
1. Setting protection disables key operations to prevent the settings from being changed accidentally. O_{TT} will be lit while protection is in effect.
 2. Protection will be maintained even when the power supply is turned OFF and ON.

Error Displays and Causes

E5L-A□

When a thermistor disconnection occurs, the built-in relay operates at the OFF side (when NO contacts are used).

Thermistor	NO contacts (Terminal numbers 8 and 12) * Heating load	NC contacts (Terminal numbers 4 and 12) * Cooling load
Disconnection	OFF	ON
Short-circuit	OFF	ON

E5L-C□

When an error occurs, the display shows the error code. Take the necessary measures, referring to the following table.

Display	Meaning	Cause	Control output
FFF (lit)	Overflow	The process value is higher than the set temperature range.	Reverse operation: OFF Direct operation: ON
--- (lit)	Underflow	The process value is lower than the set temperature range	Reverse operation: ON Direct operation: OFF
FFF (flashing)	Thermistor short-circuited	The thermistor is short-circuited.	Reverse operation: OFF Direct operation: OFF
--- (flashing)	Thermistor disconnected	The thermistor is disconnected.	Reverse operation: OFF Direct operation: OFF
E11 (lit)	Memory error	The thermostat has failed.	OFF

- Note:**
1. Errors are not displayed while settings are being changed, except for memory errors. The control output status will be as shown in the above table while the set temperature or hysteresis is being set. The control output will be OFF while the temperature input shift or direct/reverse operation setting is being set. Key operations will be possible when an error occurs, except for a memory error.
 2. The setting protection indicator (O_{TT}) and set value indicator ("SV") will be continued even when settings are protected, except when a memory error occurs.

Safety Precautions

⚠ CAUTION

Do not touch the terminals while power is being supplied. Doing so may occasionally result in minor injury due to electric shock.



Do not allow pieces of metal, wire clippings, or fine metallic shavings or filings from installation to enter the Product. Doing so may occasionally result in electric shock, fire, or malfunction.



Do not use the Product where subject to flammable or explosive gas. Otherwise, minor injury from explosion may occasionally occur.



Never disassemble, modify, or repair the Product or touch any of the internal parts. Minor electric shock, fire, or malfunction may occasionally occur.



If the output relays are used past their life expectancy, contact fusing or burning may occasionally occur. Always consider the application conditions and use the output relays within their rated load and electrical life expectancy. The life expectancy of output relays varies considerably with the output load and switching conditions.



Tighten the terminal screws to between 0.74 and 0.90 N·m. Loose screws may occasionally result in fire.



Set the parameters and wiring of the Product so that they are suitable for the system being controlled. Unexpected operation may occasionally result in property damage or accidents.



A malfunction in the Product may occasionally make control operations impossible or prevent alarm outputs, resulting in property damage. To maintain safety in the event of malfunction of the Product, take appropriate safety measures, such as installing a monitoring device on a separate line.



Precautions for Safe Use

Be sure to observe the following precautions to prevent failure to operate, malfunction, or adverse effects on the performance and functions of the Thermostat. Not doing so may occasionally result in unexpected events.

1. The Product is designed for indoor use only. Do not use the Product outdoors or in any of the following locations.
 - Locations directly subject to heat radiated from heating equipment
 - Locations subject to water or oil
 - Locations subject to direct sunlight
 - Locations subject to dust or corrosive gas (in particular, sulfide gas and ammonia gas)
 - Locations subject to sudden or extreme temperature changes
 - Locations subject to icing or condensation
 - Locations subject to vibration or shock
2. Use and store the Product within the rated temperature and humidity ranges. Provide forced cooling if required.
3. To allow heat to escape, do not block the area around the Product.
4. Be sure to wire the Product properly with the correct terminal polarity.
5. Use the specified size of crimped terminals for wiring (M3.5, width of 6.8 mm or less). To connect bare wires to the terminals, use copper wires with a gauge of AWG24 to AWG14 (equal to a cross-sectional area of 0.205 to 2.081 mm²). (The stripping length is 5 to 6 mm.) Do not connect more than two wires or two crimp terminals to one terminal. When connecting two wires, they must be of the same size and type.
6. Do not connect anything to terminals that are not used.
7. Allow as much space as possible between the Thermostat and devices that generate powerful high frequencies or surges. Separate the wiring to the Thermostat from high-voltage or high-current lines, and do not place the wiring to the Thermostat in parallel with or in the same wiring paths as power lines.
8. Use this Product within the rated load and power supply specifications.
9. Turn ON the power supply at least 30 minutes prior to starting control operations.
10. A switch or circuit breaker must be provided close to the Thermostat. The switch or circuit breaker must be within easy reach of the operator, and must be marked as a disconnecting means for the Thermostat.
11. Do not use paint thinner or similar solvents to clean the Thermostat. Use standard grade alcohol.
12. Design the system (e.g., the control panel) considering the 2.5 second of delay between turning ON the Thermostat and stabilization of the Thermostat's output.

Precautions for Correct Use

Mounting the Thermostat

- Using the PTF14A Socket, PTF14A-E Socket with Finger Protection and PTF-14-PU-L Socket with Push-In Plus technology, mount the Thermostat to the bracket (Y92H-10) that is provided.

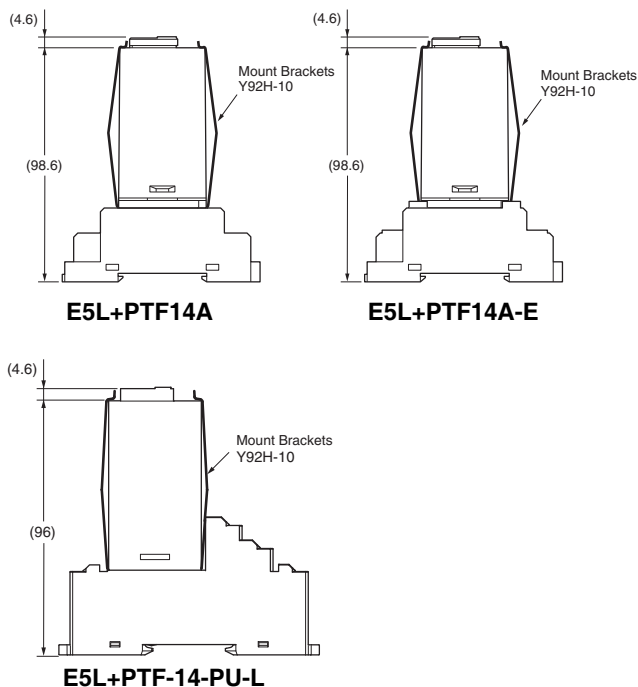

- The structure does not allow the case to be removed. Do not apply excessive force when mounting the Thermostat.

Settings

- E5L-A□ Temperature Dial
 - The temperature dial has some backlash. To adjust the temperature more accurately, turn the dial clockwise when adjusting the temperature.
 - Do not change the setting of the temperature dial more than 20 times.
 - Do not attempt to turn the dial past the range of the setting scale. Applying excessive force may damage the Thermostat.
- E5L-A□ Hysteresis Dial
 - This dial can be used to set hysteresis for the ON/OFF operation. Turn the dial clockwise to increase the hysteresis and counterclockwise to reduce the hysteresis. Increase the hysteresis to extend the life of the relay by preventing relay chattering caused by the control output turning ON and OFF frequently.
 - Do not change the setting of the temperature dial more than 20 times.

Mounting the Thermistor

- Select a location for the temperature sensor of the thermistor where the temperature distribution of sensing objects will not be changed by installation.
- Insert the temperature sensor as far in as possible.
- When measuring fluid temperature, the thermistor should be installed against the current. Before mounting, take factors such as the bending moment of inertia and vibration into consideration.
- Do not apply mechanical force to the temperature-sensing part of the thermistor.
- The E52-THE□□ Thermistor can be used for applications that require metal protective tubing. Consult with your OMRON representative.

Other Precautions

- Do not use the E5L-C□ if the front sheet is peeling or torn.
- Use appropriate tools to disassemble the Thermostat for disposal.

Terms and Conditions Agreement

Read and understand this catalog.

Please read and understand this catalog before purchasing the products. Please consult your OMRON representative if you have any questions or comments.

Warranties.

- (a) Exclusive Warranty. Omron's exclusive warranty is that the Products will be free from defects in materials and workmanship for a period of twelve months from the date of sale by Omron (or such other period expressed in writing by Omron). Omron disclaims all other warranties, express or implied.
- (b) Limitations. OMRON MAKES NO WARRANTY OR REPRESENTATION, EXPRESS OR IMPLIED, ABOUT NON-INFRINGEMENT, MERCHANTABILITY OR FITNESS FOR A PARTICULAR PURPOSE OF THE PRODUCTS. BUYER ACKNOWLEDGES THAT IT ALONE HAS DETERMINED THAT THE PRODUCTS WILL SUITABLY MEET THE REQUIREMENTS OF THEIR INTENDED USE.

Omron further disclaims all warranties and responsibility of any type for claims or expenses based on infringement by the Products or otherwise of any intellectual property right. (c) Buyer Remedy. Omron's sole obligation hereunder shall be, at Omron's election, to (i) replace (in the form originally shipped with Buyer responsible for labor charges for removal or replacement thereof) the non-complying Product, (ii) repair the non-complying Product, or (iii) repay or credit Buyer an amount equal to the purchase price of the non-complying Product; provided that in no event shall Omron be responsible for warranty, repair, indemnity or any other claims or expenses regarding the Products unless Omron's analysis confirms that the Products were properly handled, stored, installed and maintained and not subject to contamination, abuse, misuse or inappropriate modification. Return of any Products by Buyer must be approved in writing by Omron before shipment. Omron Companies shall not be liable for the suitability or unsuitability or the results from the use of Products in combination with any electrical or electronic components, circuits, system assemblies or any other materials or substances or environments. Any advice, recommendations or information given orally or in writing, are not to be construed as an amendment or addition to the above warranty.

See <http://www.omron.com/global/> or contact your Omron representative for published information.

Limitation on Liability; Etc.

OMRON COMPANIES SHALL NOT BE LIABLE FOR SPECIAL, INDIRECT, INCIDENTAL, OR CONSEQUENTIAL DAMAGES, LOSS OF PROFITS OR PRODUCTION OR COMMERCIAL LOSS IN ANY WAY CONNECTED WITH THE PRODUCTS, WHETHER SUCH CLAIM IS BASED IN CONTRACT, WARRANTY, NEGLIGENCE OR STRICT LIABILITY.

Further, in no event shall liability of Omron Companies exceed the individual price of the Product on which liability is asserted.

Suitability of Use.

Omron Companies shall not be responsible for conformity with any standards, codes or regulations which apply to the combination of the Product in the Buyer's application or use of the Product. At Buyer's request, Omron will provide applicable third party certification documents identifying ratings and limitations of use which apply to the Product. This information by itself is not sufficient for a complete determination of the suitability of the Product in combination with the end product, machine, system, or other application or use. Buyer shall be solely responsible for determining appropriateness of the particular Product with respect to Buyer's application, product or system. Buyer shall take application responsibility in all cases.

NEVER USE THE PRODUCT FOR AN APPLICATION INVOLVING SERIOUS RISK TO LIFE OR PROPERTY OR IN LARGE QUANTITIES WITHOUT ENSURING THAT THE SYSTEM AS A WHOLE HAS BEEN DESIGNED TO ADDRESS THE RISKS, AND THAT THE OMRON PRODUCT(S) IS PROPERLY RATED AND INSTALLED FOR THE INTENDED USE WITHIN THE OVERALL EQUIPMENT OR SYSTEM.

Programmable Products.

Omron Companies shall not be responsible for the user's programming of a programmable Product, or any consequence thereof.

Performance Data.

Data presented in Omron Company websites, catalogs and other materials is provided as a guide for the user in determining suitability and does not constitute a warranty. It may represent the result of Omron's test conditions, and the user must correlate it to actual application requirements. Actual performance is subject to the Omron's Warranty and Limitations of Liability.

Change in Specifications.

Product specifications and accessories may be changed at any time based on improvements and other reasons. It is our practice to change part numbers when published ratings or features are changed, or when significant construction changes are made. However, some specifications of the Product may be changed without any notice. When in doubt, special part numbers may be assigned to fix or establish key specifications for your application. Please consult with your Omron's representative at any time to confirm actual specifications of purchased Product.

Errors and Omissions.

Information presented by Omron Companies has been checked and is believed to be accurate; however, no responsibility is assumed for clerical, typographical or proofreading errors or omissions.

OMRON Corporation Industrial Automation Company
Kyoto, JAPAN

Contact: www.ia.omron.com

Regional Headquarters

OMRON EUROPE B.V.

Wegalaan 67-69, 2132 JD Hoofddorp
The Netherlands
Tel: (31)2356-81-300/Fax: (31)2356-81-388

OMRON ELECTRONICS LLC

2895 Greenspoint Parkway, Suite 200
Hoffman Estates, IL 60169 U.S.A.
Tel: (1) 847-843-7900/Fax: (1) 847-843-7787

OMRON ASIA PACIFIC PTE. LTD.

No. 438A Alexandra Road # 05-05/08 (Lobby 2),
Alexandra Technopark,
Singapore 119967
Tel: (65) 6835-3011/Fax: (65) 6835-2711

OMRON (CHINA) CO., LTD.

Room 2211, Bank of China Tower,
200 Yin Cheng Zhong Road,
PuDong New Area, Shanghai, 200120, China
Tel: (86) 21-5037-2222/Fax: (86) 21-5037-2200

Authorized Distributor:

© OMRON Corporation 2009-2019 All Rights Reserved.
In the interest of product improvement,
specifications are subject to change without notice.

CSM_2_6_0919

Cat. No. H162-E1-03

0919 (0309)