



Downlight Performer HG

- Geavanceerde, hoogwaardige LED-downlight
- Uniek optisch lensconcept met hoogglans (HG) reflector en lage verblinding
- Minimale armatuur-hoogte (max 73mm)
- Directe vervanging voor CFL downlights
- IP44 (lichtuitvoerkant)
- Voorzien van beschermingsfolie ter voorkoming van stof en vuil in het armatuur gedurende de montage



Specificaties

Artikelcode	Artikelomschrijving	Equivalent (W)	Vermogen (W)	Lumen	Efficiëntie (lm/W)	UGR	CCT (K)	CRI	Gewicht (kg/st)
Smart Lighting									
540001334800	LEDDownlightRc-P-HG R150-11.5W-BLE2-3000	CFL 1x18W	11.5	1240	108	≤19	3000	≥ 80	0,53

Accessoires



140060646
LEDDownlightRc-P-HZ-Adapter-150-175



140061242
LEDDownlightRc-P-R150-Surface-Module-WH



549098001300
LEDDownlightRc-P EM-kit 1h

549098001400
LEDDownlightRc-P EM-kit 3h



542098030700
Junction-Box-WH

Artikel- en verpakkingsinformatie

Artikel			Doosverpakking			
Artikelcode	Artikelomschrijving	EU HS Code	Afmetingen (mm) (LxBxH)	Brutogewicht (kg)	EAN	st/doos
540001334800	LEDDownlightRc-P-HG R150-11.5W-BLE2-3000	94051190	200x200x103	0,76	6931783010495	1
140060646	LEDDownlightRc-P-HZ-Adapter-150-175	94059900	200x200x0.8	0,18	6956321894122	1
140061242	LEDDownlightRc-P-R150-Surface-Module-WH	94059900	222x222x280	2,35	6956321840655	1
542098030700	Junction-Box-WH	85369010	43x103.4x26	0,06	6941408868684	1
549098001300	LEDDownlightRc-P EM-kit 1h	85044083	490x390x150	0,98	6941497709592	1
549098001400	LEDDownlightRc-P EM-kit 3h	85044083	490x390x150	1,08	6941497709585	1
560098000600	LEDSmart-Sensor Surface-Module-WH	94059200	330x220x255	0,15	6941497703972	1
821006001800	LEDSmart-BLE2-Rc-MW-Sensor	85365005	100x100x130	0,19	6941497778277	1
821006002000	LEDSmart-BLE2-Rc-PIR-Sensor	85365005	100x100x70	0,19	6941497778260	1
821009000200	LEDSmart-BLE2-Switch	85365005	89x21x101	0,10	6941497778253	1
821011002600	LEDSmart-BLE2-DALI-Connect-Box	85176200	100x60x105	0,30	6941497778291	1
821017003400	LEDSmart-BLE2-Multi-Switch-Module	94059200	46x46x30	0,07	6931783007600	1
821017003800	LEDSmart-BLE2-Relay-1000W	85364900	110x57x37	0,10	6941497778284	1

Technische specificaties	
Levensduur (L70)	70.000 u
Levensduur (L80)	50.000 u
Aan-/Uit-cycli	100.000
Kleurconsistentie (SDCM)	3
Dimbaarheid	BLE2
Bundelhoek	70°
Afwerking	Wit RAL9003
IP voorzijde	IP44
IP-klasse achterzijde	IP20
Slagvastheid	IK02
Beschermingsklasse	II
Risicogroep (EN 62471)	RG0 / RG1 (23W & 33W)
Voorschakelapparaat inbegrepen	Ja
Gloeidraadtest	650°C
Vermogensfactor	≥ 0,9

Elektrische aansluiting	
Frequentie	50/60 Hz
Nom. spanning	220-240 V
DC ingangsspanning	Zie catalogusbijlage Aansluitwaarden
230V Kabellengte	0.3 m

Materiaal eigenschappen	
Materiaal behuizing	Gegoten Aluminium
Materiaal optiek	Polycarbonaat

Toepassingscondities	
Bedrijfstemperatuur	-10-+40°C
Gebruikstemperatuur	+25°C
Opslagtemperatuur	-25-+50°C

5 JAAR GARANTIE



ENERGY

OPPLE Lighting
540001334800

12
kWh/1000h

2019/2015

Maatschets (mm)

LEDDownlightRc-P-HG R150

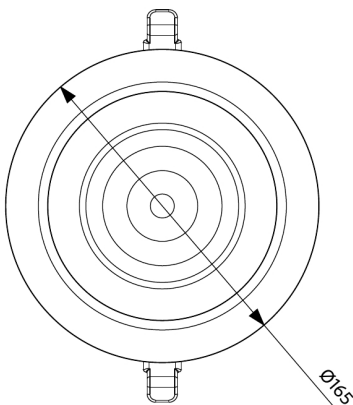

LEDDownlight Driver

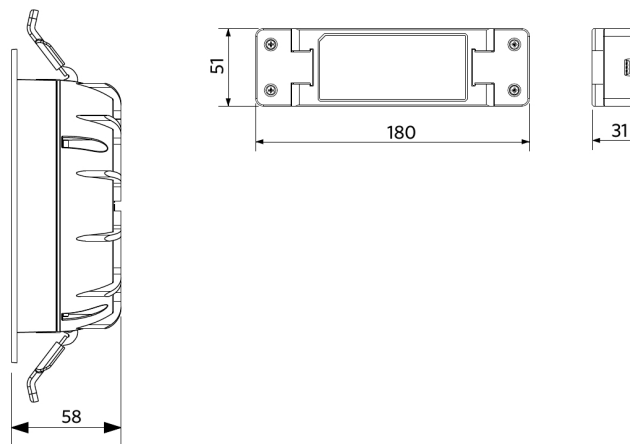

LEDDownlight Driver Tunable White

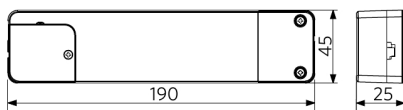

LEDDownlightRc-P-HG R150
LEDDownlightRc-P-R150-Surface-Module



Fotometrische gegevens

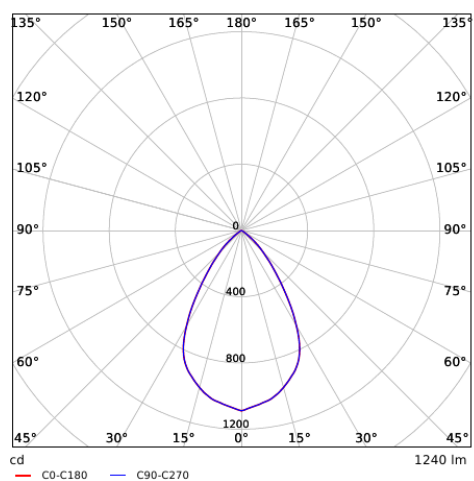

Tekening inbouwmaat (mm)

LEDDownlightRc-P-HG R150
Ø150

