

Product Data Sheet

GW95246

90 RCD Range



Description	RCCB WITH OVERCURRENT PROTECTION
Code	MDC 100
No. of poles	3P
No. modules	3
Rated current	10 A
Rated residual operating current	30 mA
Type	A
Curve	C
Rated voltage (IEC/EN 61009-1, 61009-2-1)	230/240 V

Energy limiting class	3	Standard	IEC/EN 61009-1, IEC/EN 61009-2-1
Rated frequency (Hz)	50/60 Hz	Breaking capacity IEC/EN 61009-1 230V (Icn)	10000 A
Breaking capacity IEC/EN 61009-1 400V (Icn)	10000 A	Breaking capacity IEC/EN 61009-1 (Ics)	0.75 x Icn
Breaking capacity IEC/EN 60947-2 230V (Icu)	15 kA	Breaking capacity IEC/EN 60947-2 (Ics)	50% Icu
Insulation voltage	500 V	Level of immunity (8/20 μs)	250 A
Rated impulse withstand voltage	4 kV	Overvoltage category	III
Electrical endurance	10.000	Mechanical endurance	20.000
Section rigid cable	<=1x35 - <=2x16 - <=1x16+2x10 mm ²	Section flexible cable	<=1x35 - <=2x16 - <=1x16+2x10 mm ²
Double connection	YES (only down stream)	Rated tightening torque	2 Nm
Operating temperature	-25 +60° C (derating of In with T>30° C)	Stocking temperature	-40 +70 °C
Auxiliaries compatibility	Yes	Assembly position	Any

DIMENSIONAL

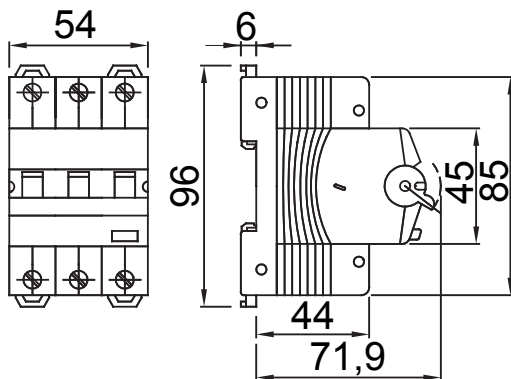

WIRING DIAGRAM

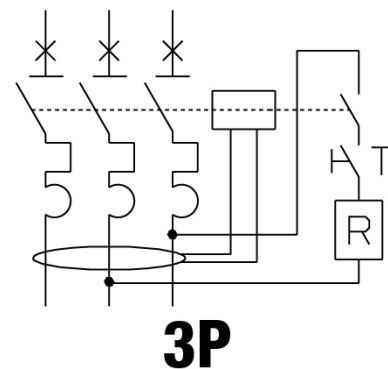

STANDARDS/APPROVALS

