

IO-Link Makes Sensor Level Information Visible and Solves the Three Major Issues at Manufacturing Sites! Standard Proximity Sensor.



- Downtime can be reduced.
Notifies you of faulty parts and such phenomena in the Sensor in real time.
- The frequency of sudden failure can be decreased.
Notifies you of objects being too far or too close.
- The efficiency of changeover can be improved.
The batch check for individual sensor IDs significantly decreases commissioning time.
- Standard Sensor for detecting ferrous metals.



For the most recent information on models that have been certified for safety standards, refer to your OMRON website.



Be sure to read *Safety Precautions* on page 5.

Ordering Information

Sensors [Refer to *Dimensions* on page 6.]

DC 3-wire IO-Link Models

Appearance		Sensing distance		Connection method	Pin arrangement	IO-Link baud rate	Model PNP
Shielded 	M12	3 mm		Pre-wired Models (2 m)	—	COM2 (38.4 kbps)	E2E-X3B4-IL2 2M
				M12 Pre-wired Smartclick Connector Models (0.3 m)	1: +V 3: 0 V 4: C/Q output	COM3 (230.4 kbps)	E2E-X3B4-IL3 2M
	M18	7 mm		Pre-wired Models (2 m)	—	COM2 (38.4 kbps)	E2E-X7B4-IL2 2M
				M12 Pre-wired Smartclick Connector Models (0.3 m)	1: +V 3: 0 V 4: C/Q output	COM3 (230.4 kbps)	E2E-X7B4-IL3 2M
	M30	10 mm		Pre-wired Models (2 m)	—	COM2 (38.4 kbps)	E2E-X10B4-IL2 2M
				M12 Pre-wired Smartclick Connector Models (0.3 m)	1: +V 3: 0 V 4: C/Q output	COM3 (230.4 kbps)	E2E-X10B4-IL3 2M
						COM2 (38.4 kbps)	E2E-X10B4-M1TJ-IL2 0.3M
						COM3 (230.4 kbps)	E2E-X10B4-M1TJ-IL3 0.3M

Note: Please contact your OMRON sales representative regarding the IO-Link setup file (IODD file).

Accessories (Sold Separately)

Sensor I/O Connectors

(Models with Pre-wired Connectors: A Connector is not provided with the Sensor. Be sure to order a Connector separately.)

Type	Appearance	Cable length	Sensor I/O Connector model number	Applicable Proximity Sensor model number
Socket on one cable end	Straight 	2 m	XS5F-D421-D80-F	E2E-X□B4-M1TJ-IL□
		5 m	XS5F-D421-G80-F	
	L-shape 	2 m	XS5F-D422-D80-F	
		5 m	XS5F-D422-G80-F	
Socket and plug on cable ends*	Straight/straight 	2 m	XS5W-D421-D81-F	
		5 m	XS5W-D421-G81-F	
	L-shape/L-shape 	2 m	XS5W-D422-D81-F	
		5 m	XS5W-D422-G81-F	

Note: Refer to *Sensor I/O Connector/Sensor Controller* on your OMRON website for details.

* There are also straight type/L-shape type combinations available.

Ratings and Specifications

DC 3-wire IO-Link Models (E2E-X□B4-IL□)

Item	Size Shielded Model	M12	M18	M30
		Shielded		
		E2E-X3B4-IL□	E2E-X7B4-IL□	E2E-X10B4-IL□
Sensing distance		3 mm ±10%	7 mm ±10%	10 mm ±10%
Set distance *1		0 to 2.4 mm	0 to 5.6 mm	0 to 8 mm
Differential travel		10% max. of sensing distance		
Detectable object		Ferrous metal (The sensing distance decreases with non-ferrous metal. Refer to <i>Engineering Data</i> on pages 3.)		
Standard sensing object		Iron, 12 × 12 × 1 mm	Iron, 18 × 18 × 1 mm	Iron, 30 × 30 × 1 mm
Response frequency *2		1 kHz	0.5 kHz	0.4 kHz
Power supply voltage		10 to 30 VDC (including 10% ripple (p-p))		
Current consumption		20 mA max.		
Control output	Load current	100 mA max.		
	Residual voltage	2 V max. (Load current: 100 mA, Cable length: 2 m)		
Indicators *1		In the Standard I/O mode (SIO mode): Operation indicator (orange, lit) and stability indicator (green, lit) In the IO-Link mode: Operation indicator (orange, lit) and communication indicator (green, blinking at 1 s intervals)		
Operation mode		PNP NO/NC switching type (Factory setting: NO) Refer to the timing charts under <i>I/O Circuit Diagrams</i> on page 4 for details.		
Protection circuits		Power supply reverse polarity protection, output reverse polarity protection, surge suppressor, and output short-circuit protection		
Ambient temperature range		Operating/Storage: -25 to 70°C (with no icing or condensation)		
Ambient humidity range		Operating/Storage: 35% to 95% (with no condensation)		
Temperature influence		±10% max. of sensing distance at 23°C in the temperature range of -25 to 70°C		
Voltage influence		±1% max. of sensing distance at rated voltage in the rated voltage ±15% range		
Insulation resistance		50 MΩ min. (at 500 VDC) between current-carrying parts and case		
Dielectric strength		1,000 VAC, 50/60 Hz for 1 minute between current-carrying parts and case		
Vibration resistance		Destruction: 10 to 55 Hz, 1.5-mm double amplitude for 2 hours each in X, Y, and Z directions		
Shock resistance		Destruction: 1,000 m/s ² 10 times each in X, Y, and Z directions		
Degree of protection		IEC 60529 IP67, in-house standards: oil-resistant *3		
Connection method		Pre-wired Models (Standard cable length: 2 m), Pre-wired Connector Models (Standard cable length: 0.3 m)		
Materials	Case	Nickel-plated brass		
	Sensing surface	PBT		
	Clamping nuts	Nickel-plated brass		
	Toothed washer	Zinc-plated iron		
Main IO-Link functions		Operation mode switching between NO and NC, self diagnosis enabling, excessive proximity judgment distance selecting, timer function of the control output and timer time selecting, instability output (IO-Link mode) ON delay timer time selecting function, monitor output, operating hours read-out, and initial reset		
Communication specifications	IO-Link specification	Ver 1.1		
	Baud rate	-IL3: COM3 (230.4 kbps), -IL2: COM2 (38.4 kbps)		
	Data length	PD size: 2 bytes, OD size: 1 byte (M-sequence type: TYPE_2_2)		
	Minimum cycle time	-IL3 (COM3): 1 ms, -IL2 (COM2): 2.3 ms		
Accessories		Instruction manual		

Note: Please contact your OMRON sales representative regarding the IO-Link setup file (IODD file).

*1. In the Standard I/O mode (SIO mode), use the product in a range that the green stability indication lamp is lit. (Although the lamp is turned off when the object detected has approached excessively, the detection performance is stable.)

In the IO-Link mode, use the product in a range that the Byte1_bit4 for instability detection is zero. (Although the Byte1_bit5 for excessive proximity detection is one if the object detected has approached excessively, the detection performance is stable.)

Please contact your OMRON sales representative regarding assignment of data.

*2. The response frequency is an average value. Measurement conditions are as follows: standard sensing object, a distance of twice the standard sensing object, and a set distance of half the sensing distance.

*3. Oil resistance in-house standard: Performance with respect to water insoluble oil.
(Test at right)

Oil resistance test

After the test time elapses, the characteristics below are checked for problems.

- (1) Visual appearance (no damage that affects product characteristics)
- (2) Operation check (ON/OFF)
- (3) Insulation resistance (50 MΩ min. at 500 VDC)
- (4) Dielectric strength (500 VAC, 1 min.)
- (5) Water resistance (IP67)

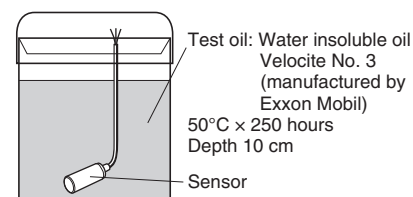

Engineering Data (Reference Value)

Sensing Area

E2E-X□B4 (-M1TJ) -IL□

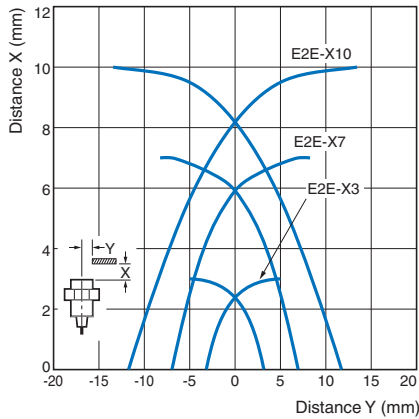

Influence of Sensing Object Size and Material

E2E-X3B4 (-M1TJ) -IL□

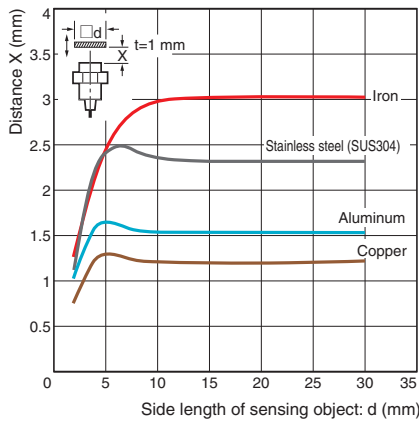

E2E-X7B4 (-M1TJ) -IL□

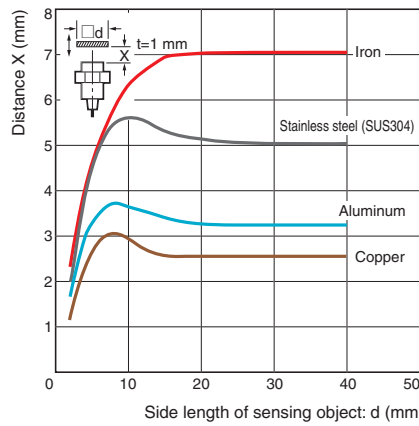

E2E-X10B4 (-M1TJ) -IL□

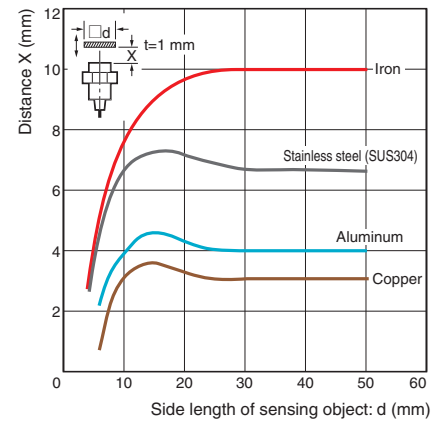

Monitor Output

E2E-X3B4 (-M1TJ) -IL□

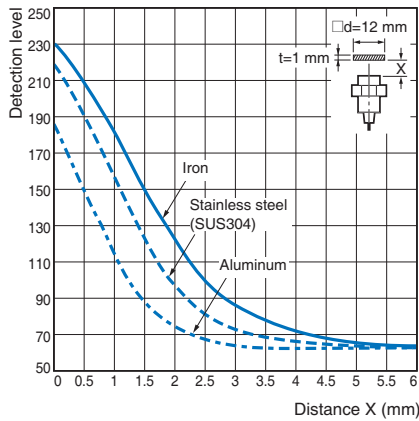

E2E-X7B4 (-M1TJ) -IL□

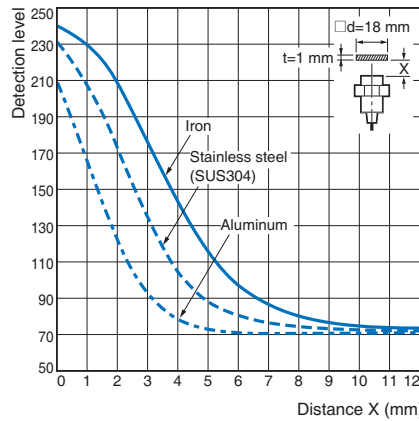

E2E-X10B4 (-M1TJ) -IL□

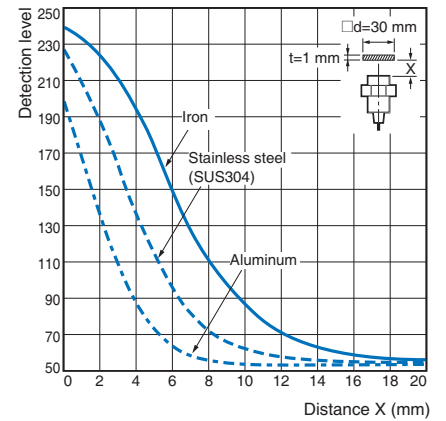

I/O Circuit Diagrams

Timing Chart

The timing chart illustrates the sensor's response to an object's proximity. It is divided into three sensing zones: Non-sensing zone (0-20%), Unstable sensing zone (20-80%), and Stable sensing zone (80-100%). The 'Rated sensing distance (%)' is indicated at the top. A 'Sensing object' is shown entering the zones. A 'Proximity Sensor' diagram is also included. The chart shows the states of the Stability indicator (green), Operation indicator (orange), and Control output *5 (yellow) for both NO and NC configurations in Standard I/O mode and IO-Link mode. In IO-Link mode, a flashing communication indicator (green) is also shown. Bit assignments for Control output *5, Instability detection *6, and Excessive proximity detection are provided for each mode.

*1. The operation mode can be changed by the IO-Link communications.

*2. If the excessive proximity diagnosis function using the IO-Link communications is disabled, the lamp is lit in this zone, too, in the Standard I/O mode (SIO mode). In the IO-Link mode, diagnosis is disabled (fixed to zero).

*3. If the instability detection diagnosis function using the IO-Link communications is disabled, the lamp is lit in this zone, too, in the Standard I/O mode (SIO mode). In the IO-Link mode, diagnosis is disabled (fixed to zero).

*4. If both the diagnosis functions of excessive proximity and instability detection using the IO-Link communications are disabled, the lamp is not lit in all the zones.

*5. The timer function of the control output can be set up by the IO-Link communications. (It is able to select ON delay, OFF delay, or one-shot function and select a timer time of 1 to 4000 ms (T).)

	ON-delay	OFF-delay	One Shot
Sensing object Present	[ON pulse]	[OFF pulse]	[ON pulse]
Sensing object Not present	[OFF pulse]	[ON pulse]	[OFF pulse]
NO ON 1	[ON pulse]	[OFF pulse]	[ON pulse]
NO OFF 0	[OFF pulse]	[ON pulse]	[OFF pulse]
NC ON 1	[ON pulse]	[OFF pulse]	[ON pulse]
NC OFF 0	[OFF pulse]	[ON pulse]	[OFF pulse]

*6. The judgment time for the instability detection diagnosis can be selected by the IO-Link communications. (For the ON delay timer function, the setting can be selected from 0 (invalid), 10, 50, 100, 300, 500, or 1000 ms.)

*7. The judgment distance of the excessive proximity diagnosis function can be selected by the IO-Link communications. (The distance can be selected as a combination of the material of the object detected, such as iron, aluminum, or SUS and the judgment distance of approximately 10, 20, or 30%. However, it is not allowed to select a combination of aluminum and 30%.)

*8. If using the product as a general sensor, it operates in the Standard I/O mode (SIO mode).

Note: Please contact your OMRON sales representative regarding assignment of data.

Output circuit

When using as a general sensor

When using the Sensor connected to IO-Link Master Unit

Pre-wired Connector Model Connections

Model	Connections
E2EQ-X□B4-M1TJ-IL□	<div style="display: flex; justify-content: space-around; align-items: center;"> <div style="text-align: center;"> <p>E2E</p> </div> <div style="text-align: center;"> <p>XS5F</p> </div> </div> <p style="text-align: right; margin-top: 10px;">* ○ Brown (+V) ○ White (not used) ○ Blue (0V) ○ Black (Output)</p>

* If the XS5W-D42□-□81-F Connector which has a socket and plug on the cable ends is connected to the Sensor, this part will be a plug.



Safety Precautions

Be sure to read the precautions for all models in the website at: <http://www.ia.omron.com/>.

Warning Indications

 Warning	Warning level Indicates a potentially hazardous situation which, if not avoided, will result in minor or moderate injury, or may result in serious injury or death. Additionally there may be significant property damage.
Precautions for Safe Use	Supplementary comments on what to do or avoid doing, to use the product safely.
Precautions for Correct Use	Supplementary comments on what to do or avoid doing, to prevent failure to operate, malfunction or undesirable effect on product performance.

Meaning of Product Safety Symbols

	General prohibition Indicates the instructions of unspecified prohibited action.
	Caution, explosion Indicates the possibility of explosion under specific conditions.

Warning

This product is not designed or rated for ensuring safety of persons either directly or indirectly. Do not use it for such purposes.



Risk of explosion.

Do not connect sensor to AC power supply.



Precautions for Safe Use

The following precautions must be observed to ensure safe operation.

- Do not use the product in an environment where flammable or explosive gas is present.
- Do not attempt to disassemble, repair, or modify the product.
- Power Supply Voltage**
Do not use a voltage that exceeds the rated operating voltage range. Applying a voltage that is higher than the operating voltage range may result in damage or burnout.
- Incorrect Wiring**
Be sure that the power supply polarity and other wiring is correct. Incorrect wiring may cause explosion or burnout.
- Connection without a Load**
If the power supply is connected directly without a load, the internal elements may explode or burn. Be sure to insert a load when connecting the power supply.
- Dispose of this product as industrial waste.

Precautions for Correct Use

Do not use this product under ambient conditions that exceed the ratings.

● Operating Environment

- Do not install the product in the following locations. Doing so may result in product failure or malfunction.
 - Outdoor locations directly subject to sunlight, rain, snow, water droplets, or oil.
 - Locations subject to atmospheres with chemical vapors, in particular solvents and acids.
 - Locations subject to corrosive gases.
- The Sensor may malfunction if used near ultrasonic cleaning equipment, high-frequency equipment, transceivers, cellular phones, inverters, or other devices that generate a high-frequency electric field. Please refer to the Precautions for Correct Use on the OMRON website (www.ia.omron.com) for typical measures.
- Laying the Proximity Sensor wiring in the same conduit or duct as high-voltage wires or power lines may result in incorrect operation and damage due to induction. Wire the Sensor using a separate conduit or independent conduit.

- Never use thinner or other solvents. Otherwise, the Sensor surface may be dissolved.

● Design

Influence of Surrounding Metal

When mounting the Sensor within a metal panel, ensure that the clearances given in the following table are maintained. Failure to maintain these distances may cause deterioration in the performance of the Sensor.

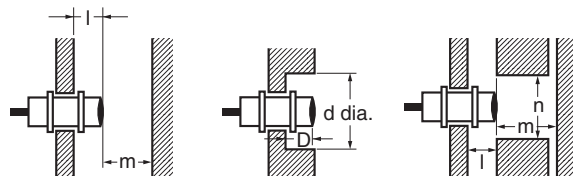

(Unit: mm)

Model	Item	l	d	D	m	n
E2E-X3B4 (-M1TJ) -IL□	0	0	12	0	8	18
E2E-X7B4 (-M1TJ) -IL□			18		20	27
E2E-X10B4 (-M1TJ) -IL□			30		40	45

Mutual Interference

When installing Sensors face-to-face or side-by-side, ensure that the minimum distances given in the following table are maintained.

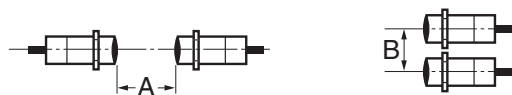

(Unit: mm)

Model	Item	A	B
E2E-X3B4 (-M1TJ) -IL□	0	30	20
E2E-X7B4 (-M1TJ) -IL□		50	35
E2E-X10B4 (-M1TJ) -IL□		100	70

● Mounting

Tightening Force

Do not tighten the nut with excessive force. A washer must be used with the nut. Do not use tightening force that exceeds the values in the following table.



Model	Item	Torque
E2E-X3B4 (-M1TJ) -IL□	0	30 N·m
E2E-X7B4 (-M1TJ) -IL□		70 N·m
E2E-X10B4 (-M1TJ) -IL□		180 N·m

● Wiring

In the IO-Link mode, the cable between the IO-link Master and Sensor must have a length of 20m or less.

Dimensions

(Unit: mm)
Tolerance class IT16 applies to dimensions in this data sheet unless otherwise specified.

Pre-wired Models

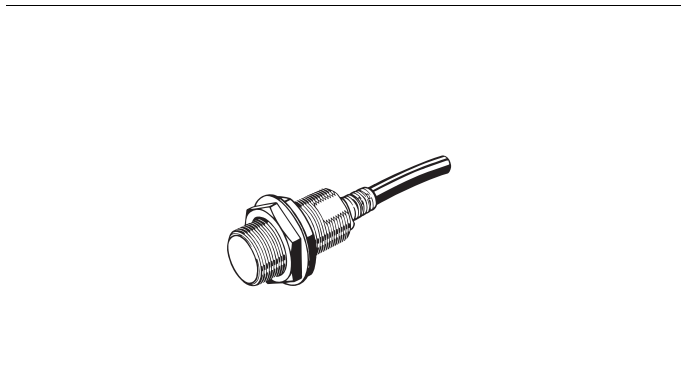

E2E-X3B4-IL□

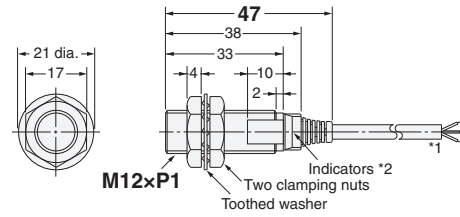

*1. 4-dia. vinyl-insulated round cable with 3 conductors (Conductor cross section: 0.3 mm², Insulator diameter: 1.3 mm), Standard length: 2 m
*2. Operation indicator (orange), stability indicator/communication indicator (green)

E2E-X7B4-IL□

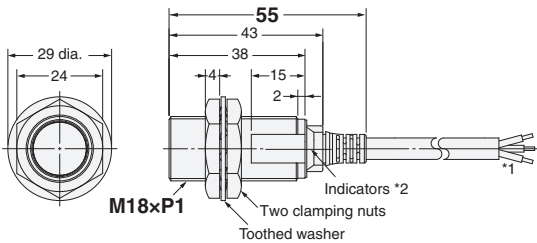

*1. 6-dia. vinyl-insulated round cable with 3 conductors (Conductor cross section: 0.5 mm², Insulator diameter: 1.9 mm), Standard length: 2 m
*2. Operation indicator (orange), stability indicator/communication indicator (green)

E2E-X10B4-IL□

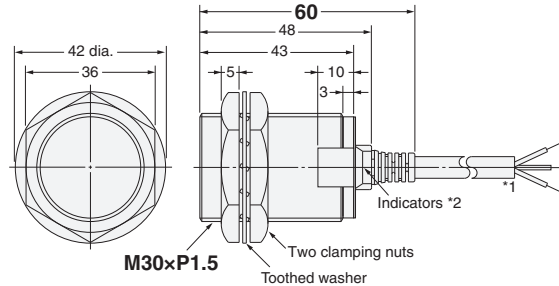

*1. 6-dia. vinyl-insulated round cable with 3 conductors (Conductor cross section: 0.5 mm², Insulator diameter: 1.9 mm), Standard length: 2 m
*2. Operation indicator (orange), stability indicator/communication indicator (green)

Pre-wired Connector Models

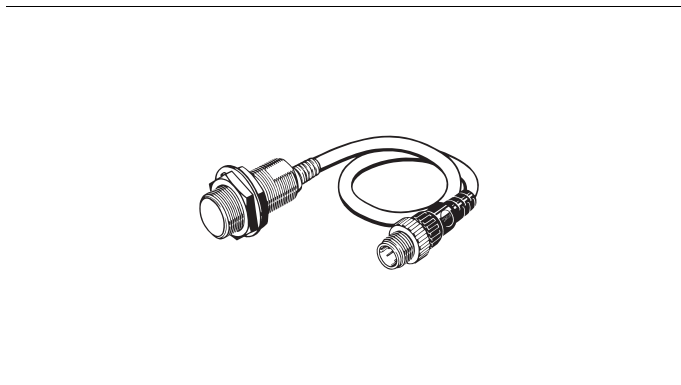

E2E-X3B4-M1TJ-IL□

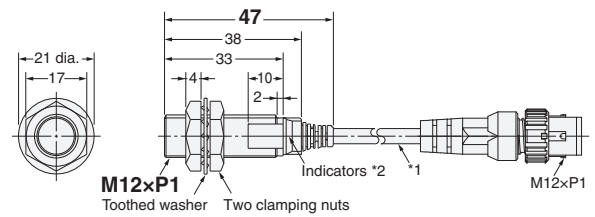

*1. 4-dia. vinyl-insulated round cable Standard length: 0.3 m
*2. Operation indicator (orange), stability indicator/communication indicator (green)

E2E-X7B4-M1TJ-IL□

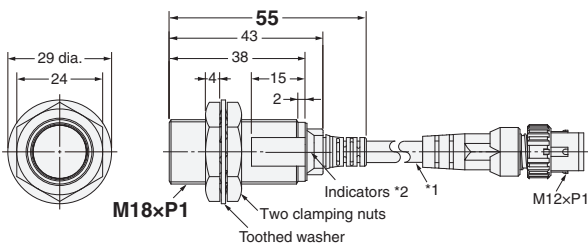

*1. 6-dia. vinyl-insulated round cable Standard length: 0.3 m
*2. Operation indicator (orange), stability indicator/communication indicator (green)

E2E-X10B4-M1TJ-IL□

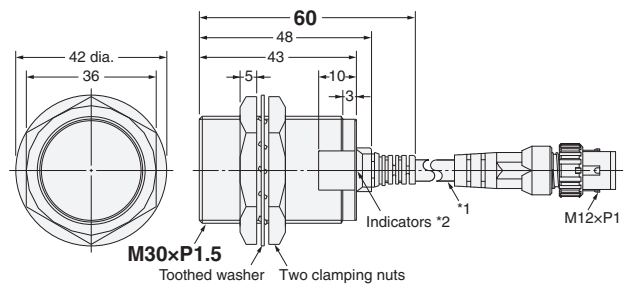

*1. 6-dia. vinyl-insulated round cable Standard length: 0.3 m
*2. Operation indicator (orange), stability indicator/communication indicator (green)

Mounting Hole Dimensions



Dimension	M12	M18	M30
F (mm)	12.5 ^{+0.5} dia.	18.5 ^{+0.5} dia.	30.5 ^{+0.5} dia.

Terms and Conditions Agreement

Read and understand this catalog.

Please read and understand this catalog before purchasing the products. Please consult your OMRON representative if you have any questions or comments.

Warranties.

(a) Exclusive Warranty. Omron's exclusive warranty is that the Products will be free from defects in materials and workmanship for a period of twelve months from the date of sale by Omron (or such other period expressed in writing by Omron). Omron disclaims all other warranties, express or implied.

(b) Limitations. OMRON MAKES NO WARRANTY OR REPRESENTATION, EXPRESS OR IMPLIED, ABOUT NON-INFRINGEMENT, MERCHANTABILITY OR FITNESS FOR A PARTICULAR PURPOSE OF THE PRODUCTS. BUYER ACKNOWLEDGES THAT IT ALONE HAS DETERMINED THAT THE PRODUCTS WILL SUITABLY MEET THE REQUIREMENTS OF THEIR INTENDED USE.

Omron further disclaims all warranties and responsibility of any type for claims or expenses based on infringement by the Products or otherwise of any intellectual property right. (c) Buyer Remedy. Omron's sole obligation hereunder shall be, at Omron's election, to (i) replace (in the form originally shipped with Buyer responsible for labor charges for removal or replacement thereof) the non-complying Product, (ii) repair the non-complying Product, or (iii) repay or credit Buyer an amount equal to the purchase price of the non-complying Product; provided that in no event shall Omron be responsible for warranty, repair, indemnity or any other claims or expenses regarding the Products unless Omron's analysis confirms that the Products were properly handled, stored, installed and maintained and not subject to contamination, abuse, misuse or inappropriate modification. Return of any Products by Buyer must be approved in writing by Omron before shipment. Omron Companies shall not be liable for the suitability or unsuitability or the results from the use of Products in combination with any electrical or electronic components, circuits, system assemblies or any other materials or substances or environments. Any advice, recommendations or information given orally or in writing, are not to be construed as an amendment or addition to the above warranty.

See <http://www.omron.com/global/> or contact your Omron representative for published information.

Limitation on Liability: Etc.

OMRON COMPANIES SHALL NOT BE LIABLE FOR SPECIAL, INDIRECT, INCIDENTAL, OR CONSEQUENTIAL DAMAGES, LOSS OF PROFITS OR PRODUCTION OR COMMERCIAL LOSS IN ANY WAY CONNECTED WITH THE PRODUCTS, WHETHER SUCH CLAIM IS BASED IN CONTRACT, WARRANTY, NEGLIGENCE OR STRICT LIABILITY.

Further, in no event shall liability of Omron Companies exceed the individual price of the Product on which liability is asserted.

Suitability of Use.

Omron Companies shall not be responsible for conformity with any standards, codes or regulations which apply to the combination of the Product in the Buyer's application or use of the Product. At Buyer's request, Omron will provide applicable third party certification documents identifying ratings and limitations of use which apply to the Product. This information by itself is not sufficient for a complete determination of the suitability of the Product in combination with the end product, machine, system, or other application or use. Buyer shall be solely responsible for determining appropriateness of the particular Product with respect to Buyer's application, product or system. Buyer shall take application responsibility in all cases.

NEVER USE THE PRODUCT FOR AN APPLICATION INVOLVING SERIOUS RISK TO LIFE OR PROPERTY OR IN LARGE QUANTITIES WITHOUT ENSURING THAT THE SYSTEM AS A WHOLE HAS BEEN DESIGNED TO ADDRESS THE RISKS, AND THAT THE OMRON PRODUCT(S) IS PROPERLY RATED AND INSTALLED FOR THE INTENDED USE WITHIN THE OVERALL EQUIPMENT OR SYSTEM.

Programmable Products.

Omron Companies shall not be responsible for the user's programming of a programmable Product, or any consequence thereof.

Performance Data.

Data presented in Omron Company websites, catalogs and other materials is provided as a guide for the user in determining suitability and does not constitute a warranty. It may represent the result of Omron's test conditions, and the user must correlate it to actual application requirements. Actual performance is subject to the Omron's Warranty and Limitations of Liability.

Change in Specifications.

Product specifications and accessories may be changed at any time based on improvements and other reasons. It is our practice to change part numbers when published ratings or features are changed, or when significant construction changes are made. However, some specifications of the Product may be changed without any notice. When in doubt, special part numbers may be assigned to fix or establish key specifications for your application. Please consult with your Omron's representative at any time to confirm actual specifications of purchased Product.

Errors and Omissions.

Information presented by Omron Companies has been checked and is believed to be accurate; however, no responsibility is assumed for clerical, typographical or proofreading errors or omissions.

2023.7

In the interest of product improvement, specifications are subject to change without notice.

OMRON Corporation
Industrial Automation Company

<http://www.ia.omron.com/>

(c)Copyright OMRON Corporation 2023 All Right Reserved.