

# INSTRUCTION

GSUN S  
652218.002

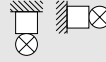



~ 220 - 240 V 50/60 Hz IP 30 IK03





 3 x 1,5 mm<sup>2</sup>



 Dauerschaltung / maintained  
=> 0 °C ... + 25 °C  
Bereitschaftsschaltung / non  
maintained  
=> 5 °C ... + 40 °C

 1/3/8 h

 2,50 mm<sup>2</sup>

 NiMH  
2,4 V - 1,8 Ah

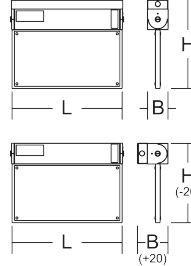

L 327, B 45, H 237

1,36 kg



**P**  [W]

**P** 

LED

2,6

1 x 3 W

**CCT** [K]

 [m]

**RG** 

**EEK** 

4000

32

RG 1

G

$f_{min} - f_{max}$   
[MHz]

$P_{EIRP}$  [mW]

13,553 - 13,567

0

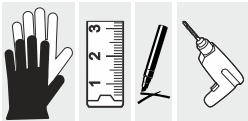



### Allgemeine Sicherheitshinweise

- Der elektrische Anschluss muss ordnungsgemäß nach geltenden Normen und den nationalen sowie internationalen Sicherheits- und Unfallverhütungsvorschriften erfolgen.
- Beschädigte Leuchten dürfen nicht betrieben werden.
- Keine Haftung für Schäden durch unsachgemäßen Einsatz.
- Bei Instandsetzung nur Originalteile verwenden.
- Tragfähigkeit der Decke und Befestigungselemente sicherstellen.

### Betrieb der Leuchte

- Die unzulässigen Umgebungstemperaturen reduzieren die Lebensdauer der Leuchte, im Extremfall droht der Frühausfall.
- Zur Vermeidung von EMV-Problemen die Durchgangsverdrahtung nicht entlang der Leuchtenverdrahtung führen.
- Steuereingänge von dimmbaren Leuchten mit handelsüblichen für Netzspannung geeigneten Leitungen anschließen.

### Manipulationen unserer Produkte sind unzulässig

Veränderung, Umarbeitung, Umkennzeichnung von Produkten sowie deren Verpackung sind unzulässig und verletzen u.a. unsere eingetragenen Warenzeichenrechte. Solche Modifikationen können technische Eigenschaften unserer Produkte negativ beeinflussen, diese zerstören und möglicherweise Folgeschäden an anderen Objekten verursachen. Für durch derartige Modifikationen verursachte Schäden kann der Hersteller in keinem Fall verantwortlich gemacht werden.



### General Safety Information

- Electric connection must be appropriate according to all applicable standards and other national and international safety and accident prevention regulations.
- Damaged luminaires must not be operated.
- No liability is accepted for damages resulting from improper use.
- Use genuine parts only for repair.
- Ensure stability of the ceiling and fastening elements.

### Operation of the luminaire

- Exceeding the permissible ambient temperature will reduce the luminaire's lifecycle, resulting in premature failure in extreme cases.
- Avoid ESD problems by not routing feed-through wiring directly along the wiring of the luminaire.
- Connect control inputs of dimmable luminaires with standard cables suitable for power supply voltage.

### Manipulation of our products is not permitted

Modifications, reworking, re-labelling of products as well as their package is not permitted and infringes, amongst others, our registered trademark rights. Such modifications may affect technical properties of our products, damage them and possibly cause consequential damage to other objects. The manufacturer shall not be responsible under any circumstances for damage caused by such modifications.



DIN EN IEC 61340-5-1

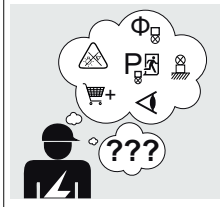

Bei Fragen zu unseren Symbolen, besuchen Sie folgende Webseite:

If you have any questions about our signs, visit the following website:



[https://www.rzb.de/fileadmin/assets/downloads/PDF/RZB\\_Symbolklaerung.pdf](https://www.rzb.de/fileadmin/assets/downloads/PDF/RZB_Symbolklaerung.pdf)

EEK

Dieses Produkt enthält eine Lichtquelle der Energieeffizienzklasse G entsprechend Verordnung (EU) 2019/2015

This product contains a light source of energy efficiency class G according to regulation (EU) No 2019/2015

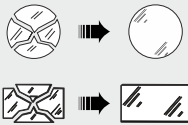

Jede zersprungene Schutzabdeckung ist zu ersetzen. DIN EN 60598

Replace any cracked protective shield. IEC DIN EN 60598

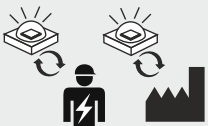

Die Lichtquelle dieser Leuchte darf nur vom Hersteller oder einem von ihm beauftragten Servicetechniker oder einer vergleichbar qualifizierten Person ersetzt werden. DIN EN 60598-1 / IEC 60598-1

The light source contained in this luminaire shall only be replaced by the manufacturer or his service agent or a similar qualified person. DIN EN 60598-1 / IEC 60598-1



Zur Verwendung in Anlagen nach EN 50172 / DIN VDE 0108-100

For installation according to EN-50172 / DIN VDE 0108-100

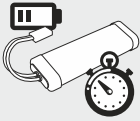

Die Sicherheitsleuchten werden generell mit entladenen oder teilentladenen Akkus ausgeliefert und müssen für die volle Funktionstüchtigkeit die vorgegebene Inbetriebnahme durchlaufen.

---

---

The emergency luminaires are delivered with either discharged or only partially charged batteries and run through the specified commissioning before reaching their fully operability.



### Einteilung Notleuchten

*	**	***	****
---	----	-----	------

Veränderungen am Auslieferungszustand der Leuchte sind gemäß DIN EN 60598-2-22 auf dem Typenschild zu kennzeichnen.

### Classification Emergency Lighting

*	**	***	****
---	----	-----	------

Modifications to the delivery condition of the luminaire must be documented on the product label accordingly to IEC 60598-2-22.

*	Typ (1-stellig)	Type (1-digit)
X	Einzelbatterie	Self-Contained
Z	Zentralbatterie	Central Supply

**	Betriebsart (1-stellig)	Operating Mode (1-digit)
0	Notleuchte Bereitschaftsschaltung	Emergency Lighting non-maintained
1	Notleuchte Dauerschaltung	Emergency Lighting maintained
2	Kombinierte Notleuchte Bereitschaftssch.	Combi. Emergency Lighting non-maintained
3	Kombinierte Notleuchte Dauerschaltung	Combined Emergency Lighting maintained

***	Einrichtungen (max. 7-stellig)	Installation (max. 7-digit)
A	manuelle Prüfeinrichtung	Manual Test Device
B	Fernschalter für Ruhe-Zustand	Including Remote Rest Mode
C	Fernausschaltemöglichkeit	Including Inhibiting Mode
D	Arbeitsstätten m. besonderer Gefährdung	High-Risk Task-Area Luminaire
E	Lampe oder Batterie nicht austauschbar	With non-replaceable Lamps or Battery
F	automatische Prüfeinrichtung	Automatic Test Device
G	von innen beleuchtetes Sicherheitszeich.	Inside illuminated safety sign

****	Betriebsdauer (2/3-stellig) (nur bei Einzelbatterie)	Duration Time (2/3-digit) (only for self-contained)
60	Betriebsdauer 60 Minuten	Duration Time 60 Minutes
180	Betriebsdauer 180 Minuten	Duration Time 180 Minutes
480	Betriebsdauer 480 Minuten	Duration Time 480 Minutes





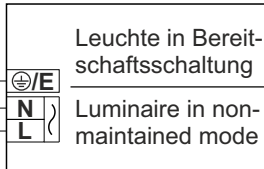
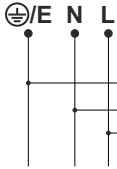





## Anschlussplan / Wiring diagram



	Schutzleiter (SK I) // Ground Wire (IC I)
<b>E</b>	Erdung (SK II) // earthing (IC II)
<b>N</b>	Nullleiter // Neutral Wire
<b>L</b>	Dauerphase // Duration Wire

## **Selbsttest EBS / Automatic Test EBS**

### **Funktionsanzeige LED / Indicator LED**

	- Grün an, alle 10s / 20s / 30s aus, bei Bemessungsbetriebsdauer 1/3/8 h / green on, every 10s / 20s / 30s out, at rated duration 1/3/8 h	- Netz vorhanden, Selbsttest aktiv / mains available, test mode active
	- Grün an, alle 10s / 20s / 30s rot blinkend bei Bemessungsbetriebsdauer 1/3/8 h / green on, every 10s / 20s / 30s red flashing at rated duration 1/3/8 h	- Netz vorhanden, Selbsttest inaktiv / mains available, test mode inactive
	- aus / out	- Notbetrieb, Netzausfall/ emergency mode, mains failure
	- Gelb, langsam blinkend/ yellow, slow flashing (1 Hz)	- Funktionstest / functional test
	- Gelb, schnell blinkend/ yellow, fast flashing (0,5 Hz)	- Bemessungsbetriebsdauertest / rated duration test
	- Gelb - Rot, blinkend/ yellow - Red, flashing	- Fehler während dem Test aufgetreten/ failure during the test
	- Rot, Dauer/ red, continuously	- Akkufehler / battery failure
	- Rot, blinkend/ red, flashing (1 Hz)	- Leuchtmittelfehler / lamp source failure
	- Rot - Grün, sehr schnell blinkend/ red - green, very fast flashing	- NFC EEPROM Fehler/ NFC EEPROM failure

### **Kontrolle nach der Installation**

30 Minuten nach der Inbetriebnahme muss die Status-LED grün leuchten. Wenn die LED nicht leuchtet, ist die Ladung durch fehlende Netzspannung, unterbrochene Leitung zum Akku oder defekte Ladeeinheit nicht gewährleistet.

### **Selbsttest**

Alle Leuchten der Baureihe enthalten ein automatisches Testsystem und überprüfen sich eigenständig. Bei den Leuchten wird wöchentl. die Einsatzbereitschaft der Elektronik, der Lampe und des Akkus geprüft. Zusätzlich wird jährl. die Kapazität des Akkus durch Simulation des Netzausfalls gemessen. Der erste Kapazitätstest erfolgt 24 Std. nach der Installation oder einer Fehlerbehebung. Nach dem Selbsttest muss die Status LED kontrolliert werden.

### **Check after installation**

30 minutes after start up must the green LED on. If the LED is off, it must be detected that the charging is not inhibited due to a missing voltage supply, due to a lineinterruption to the battery or due to a faulty electronic.

### **Automatic Test**

All luminaires of this series are assembled with an automatic self test system, testing the luminaires independently. Weekly tested are the electronic system, the lamp and the battery. Additionally, every year the battery capacity is measured by simulating a mains power failure. The first capacity test is performed 24 hours after installation or fault repair. The indicator LED must be checked after the first self-test.



### Prüfungen

Einzelbatterieleuchten sind gemäß der örtlich geltenden Vorschriften regelmäßig zu testen. Hierbei ist es ausreichend den an der Status-LED angezeigten Status der Leuchte visuell auszuwerten und ggf. unverzüglich entsprechende Maßnahmen einzuleiten um anstehende Störungen zu beheben. Die Ergebnisse der Überprüfung sind in einem Prüfbuch festzuhalten. Eine manuelle Überprüfung der Leuchte ist nicht möglich.

### Quittieren

Wenn beim Test Fehler auftreten, werden diese durch die farbige Status LED an der Leuchte angezeigt. Um die Fehleranzeige nach Behebung des Fehlers zurückzusetzen, muss die Versorgungsspannung der Leuchte kurzfristig abgeschaltet werden.

### Tests

Self-contained luminaire must be tested regularly in accordance with local regulations. It is sufficient to visually evaluate the status of the light displayed on the indicator and, if necessary, to take appropriate measures immediately to eliminate any faults. The results of the inspection are to be recorded in an inspection book. A manual check of the lamp is not possible.

### Acknowledging error status

If failure will displayed, these are indicated by colored status LED on luminare. Reset the error status after testing, the luminaire has to be disconnected from mains voltage temporarily.

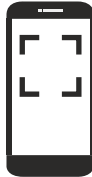
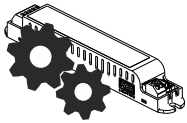

smart+IP

<https://play.google.com/store/apps/details?id=de.rzb.smartplusipapp>





**EG-Konformitätserklärung**  
**EC-Declaration of Conformity**  
**Déclaration UE de conformité**  
**Declaración de conformidad CE**  
**Deklaracja zgodności UE**



**Hersteller, Anschrift:**  
**Manufacturer, address:**  
**Fabricant, adresse:**  
**Fabricante, dirección:**  
**Producent, adres:**

**RZB Rudolf Zimmermann, Bamberg GmbH**  
**Rheinstrasse 16**  
**96052 Bamberg**  
**Deutschland / Germany / Allemagne / Alemania / Niemcy**

Wir erklären in alleiniger Verantwortung, dass das Produkt  
 We declare under sole responsibility that the product  
 Nous déclarons, sous notre propre responsabilité, que le produit  
 Declaramos bajo nuestra sola responsabilidad que el producto  
 Deklarujemy z pełną odpowiedzialnością, że produkt

**Produktbezeichnung:**  
**Product designation:** **GSUN S**  
**Description des produits:**  
**Designación de producto:** **652218.002**  
**Oznaczenie produktu:**

mit den folgenden EG-Richtlinien und Normen übereinstimmt:  
 complies with the following EC Directives and standards:  
 est conforme aux normes et directives de l'UE suivantes:  
 cumple con las siguientes directivas y normas CE:  
 jest zgodny z następującymi dyrektywami UE i normami:

<p><b>RED Directive</b> 2014/53/EU</p>	<p><b>(3.1a)</b> EN 60598-1:2021/A11:2022 EN 60598-2-1:1989 EN 60598-2-2:2022 EN 62471:2008 EN 62493:2010 <b>(3.1b)</b> EN 55015:2019/A11:2020 EN 61000-3-2:2019/A1:2021 EN 61000-3-3:2013+A1:2019+A2:2021+A2:2021/AC:2022 EN 61547:2023 <b>(3.2)</b> EN 300 330 V2.1.1</p>
<p><b>RoHS Directive</b> 2011/65/EU</p>	<p>EN 63000:2018</p>
<p><b>ErP Directive</b> 2009/125/EC</p>	<p>(EU) 2019/2020</p>

Dokument-Nr. / Document No. / Document No.  
 Document No. / Nr dokumentu **24028489**

Aussteller / Issuer / Délivré par:  
 Otorgante / Wystawca: **RZB Rudolf Zimmermann, Bamberg GmbH**

Ort, Datum / Place, Date / Lieu, date:  
 Lugar, Fecha / Miejsce, data: **Bamberg, 28.03.2024**

Rechtsverbindliche Unterschrift:  
 Legally binding signature:  
 Signature juridiquement obligatore:  
 Firma legalmente vinculante:  
 Prawnie wiązacy podpis:

  
 Reiner Jürgens  
 CEO/Direktor Zarządzający/Geschäftsführer

1/1

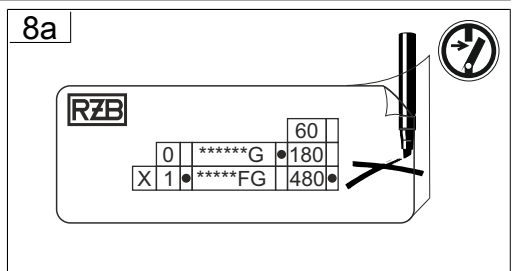
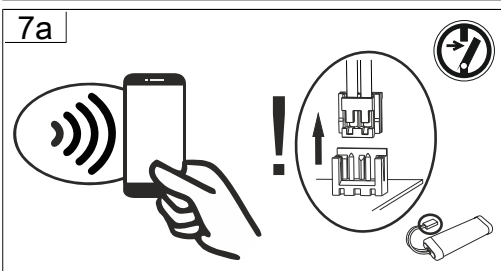
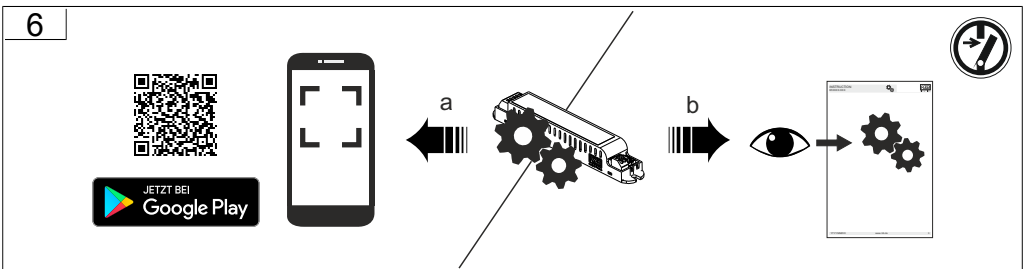
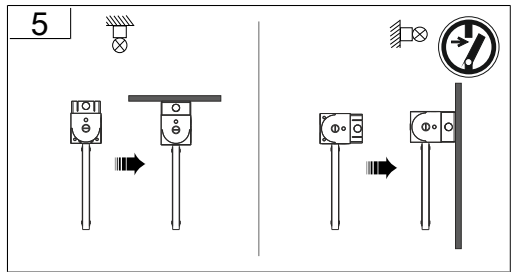
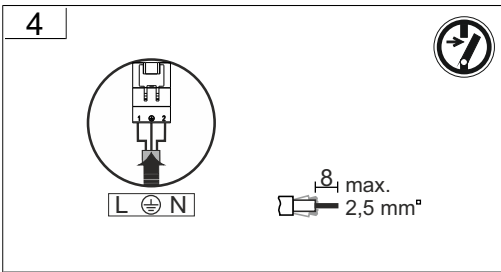
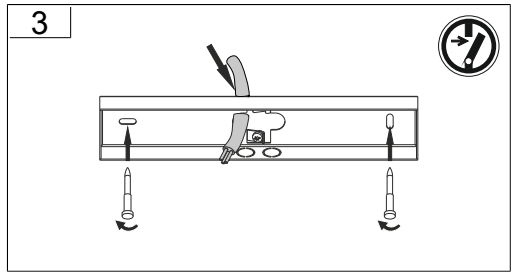
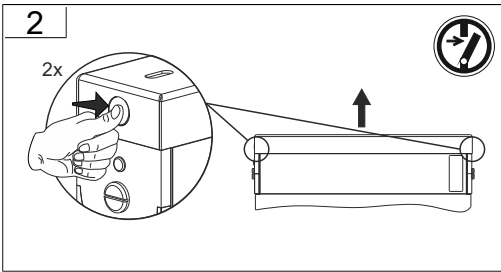
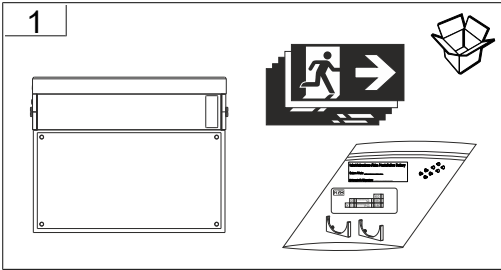
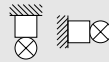

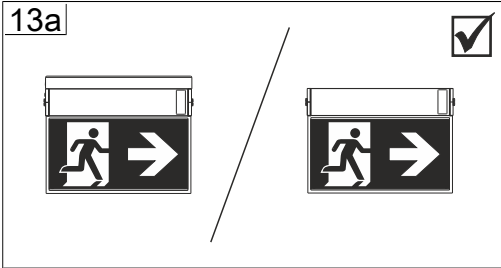
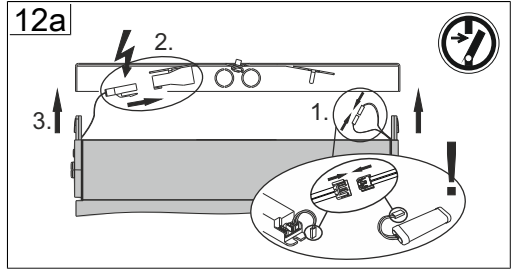
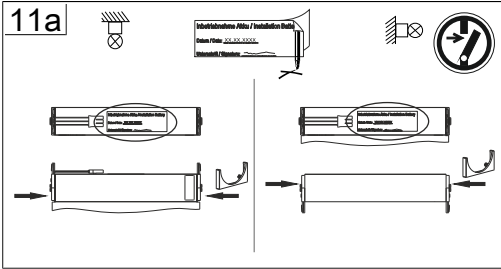
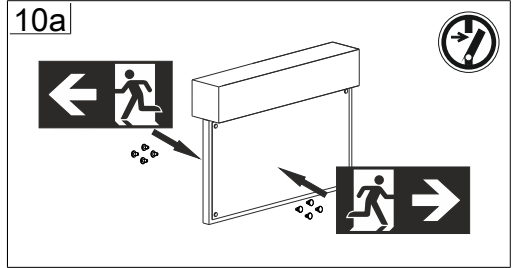
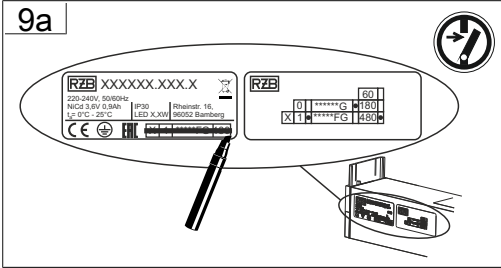
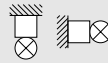

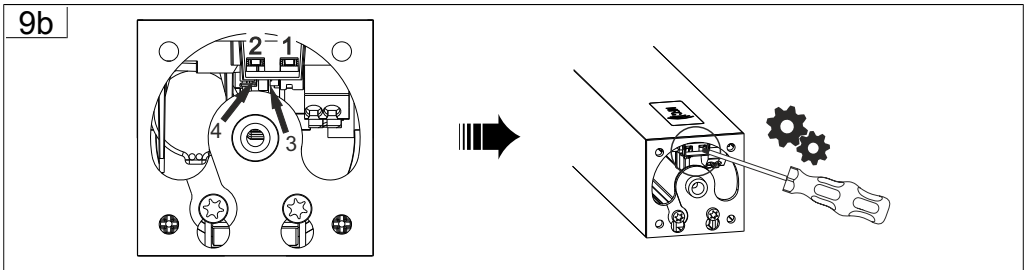
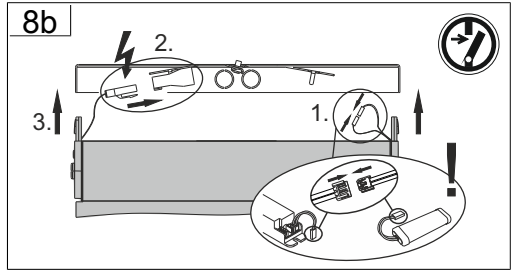
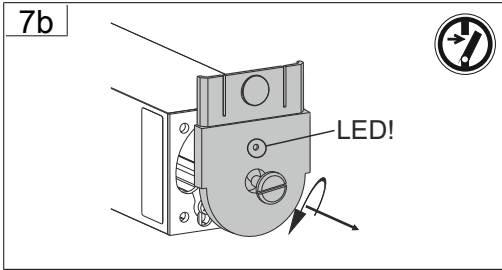



## 10b

### Manuelle Einstellungen / Manual Settings

Um in die manuellen Einstellungen zu gelangen muss der Taster (T1) 3 Sekunden lang gedrückt werden, danach leuchtet die LED (L3) orange. Sobald der Programmiermodus eingeschaltet ist, sind die Grundfunktionen (1h/ Dauerschaltung/ Selbsttest) aktiviert.

To access the manual settings, press and hold the button (T1) for 3 seconds, then the LED (L3) lights up orange. The programming made starts with basic values (1h/ maintained/ test on) other options must be confirmed.

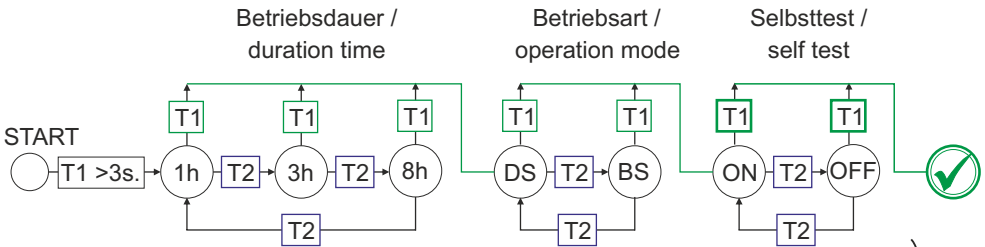

T1: Modus      T2: Option

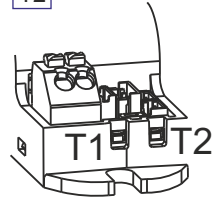

### Übersicht Statusanzeige (L4) / Overview LED indicator (L4)

	Option einstellen (T2) / Set option (T2)	Modifikation-LED Anzeige (L4) / Modification-LED indicator (L4)	
Betriebsdauer / rated duration	1h	1 x blinken / 1 x flashing	5 Hz
	3h	3 x blinken / 3 x flashing	5 Hz
	8h	8 x blinken / 8 x flashing	5 Hz
Betriebsart / operating mode	Dauerschaltung / Maintained	grün Ein / green On	
	Bereitschaftsschaltung / Non Maintained	Aus / Off	
Selbsttest / self test	Test ein / Test on	schnell blinkend / fast flashing	5 Hz
	Test aus / Test off	langsam blinkend / slow flashing	1 Hz

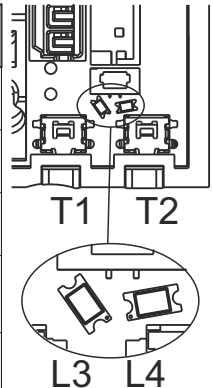



11b

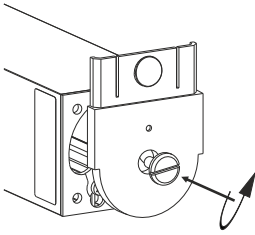

12b

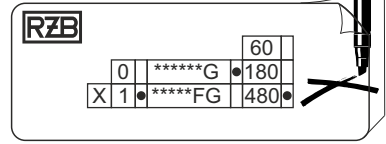

13b

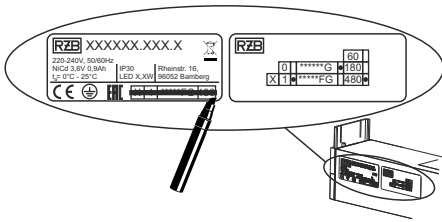

14b

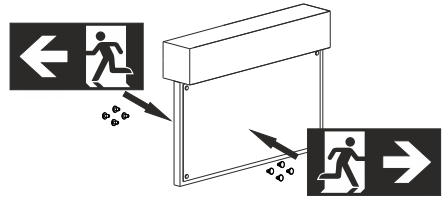

15b

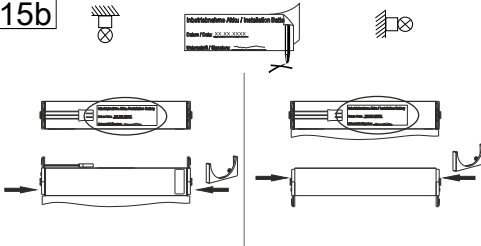

16b

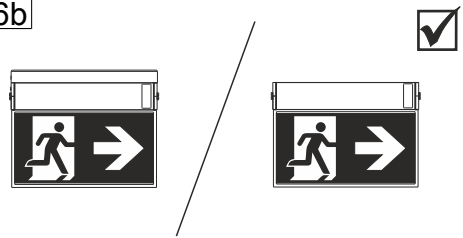

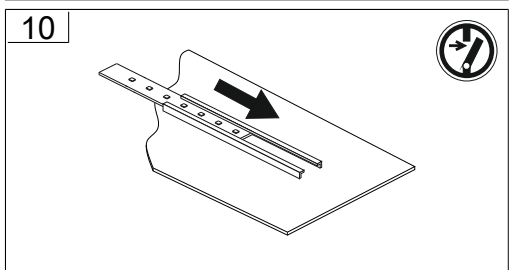
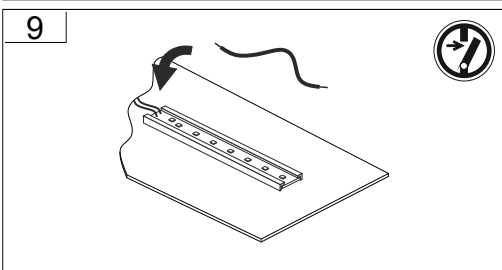
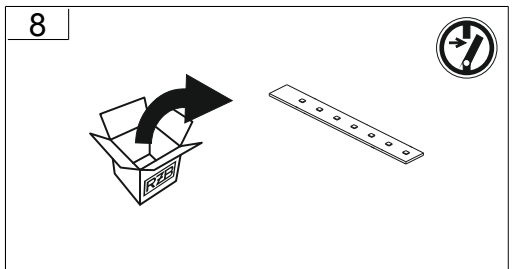
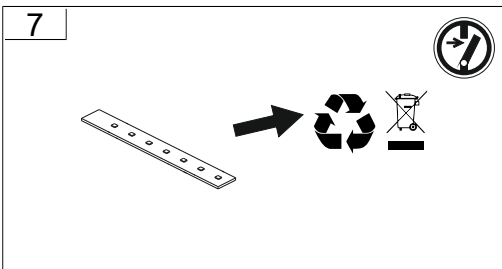
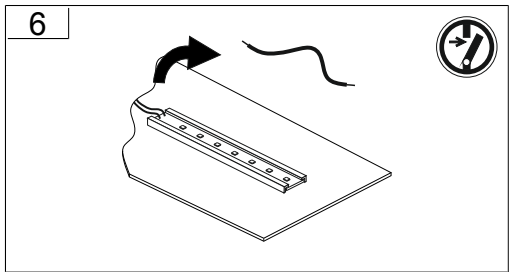
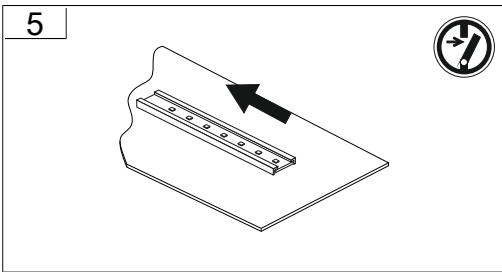
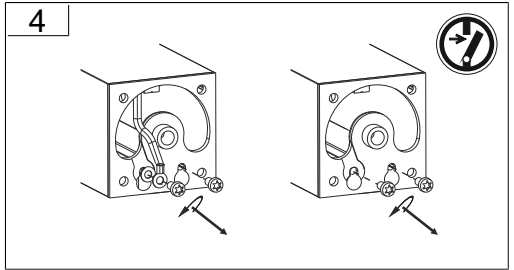
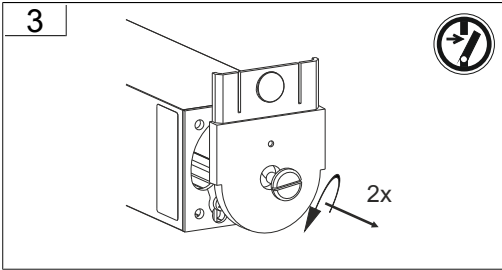
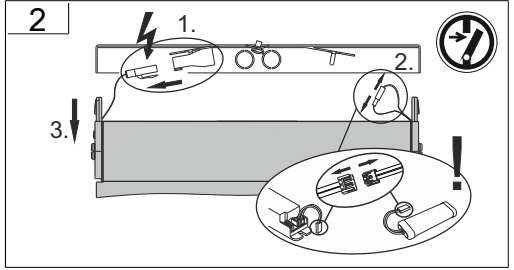
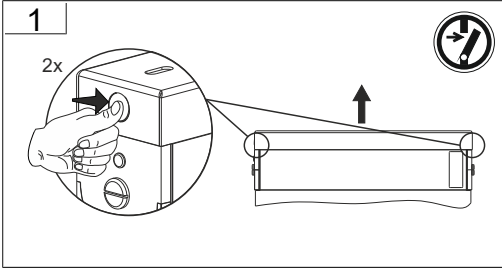

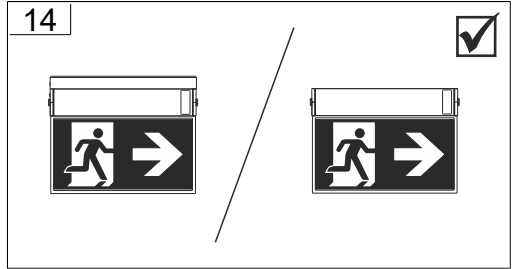
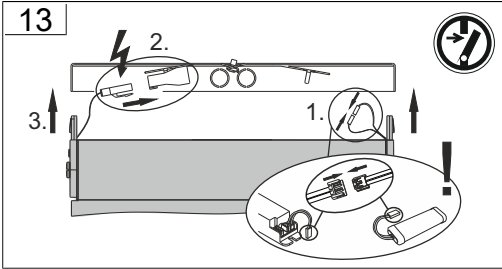
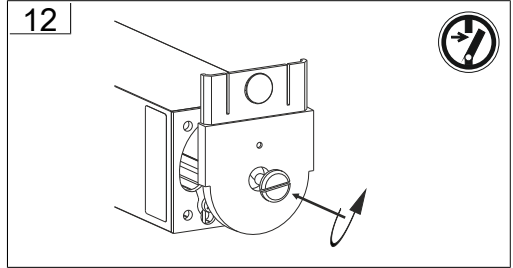
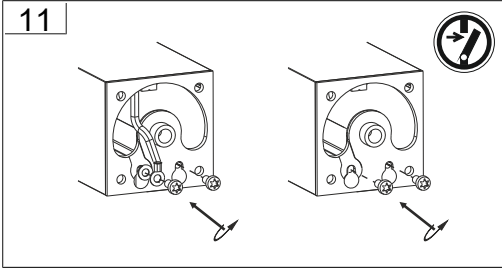



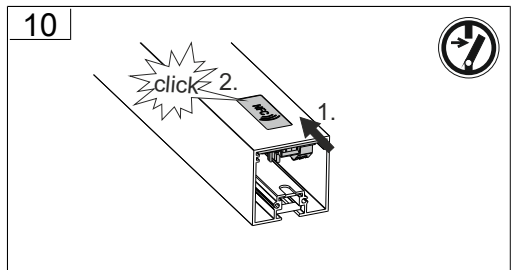
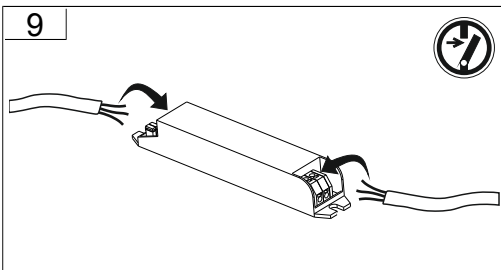
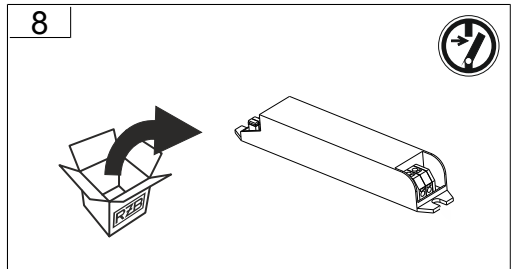
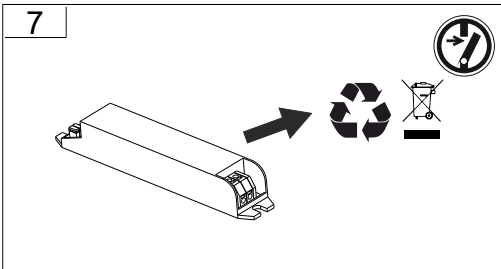
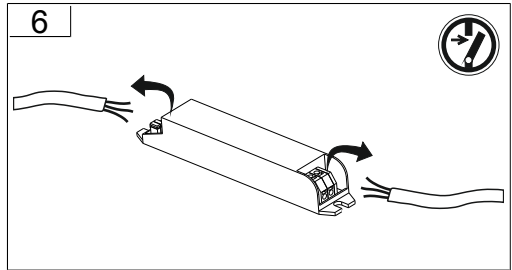
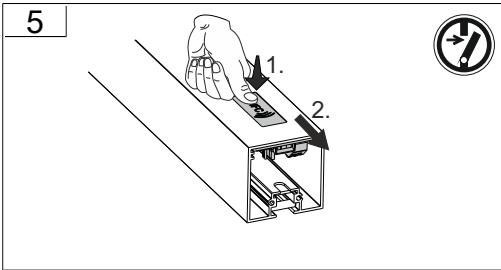
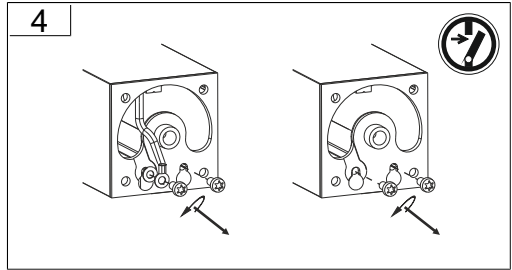
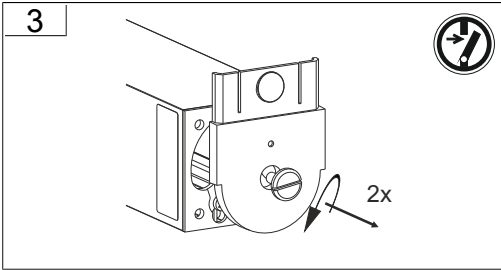
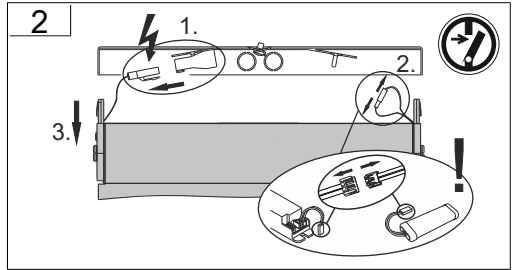
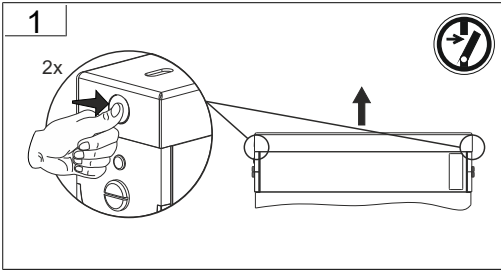

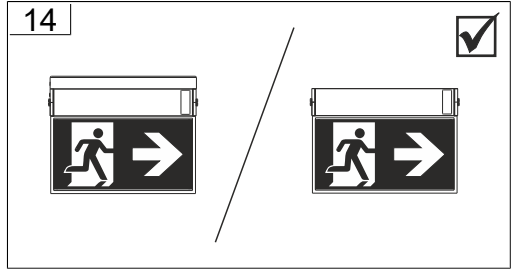
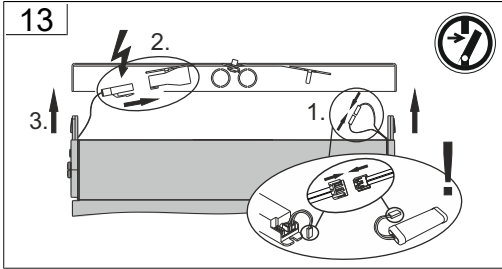
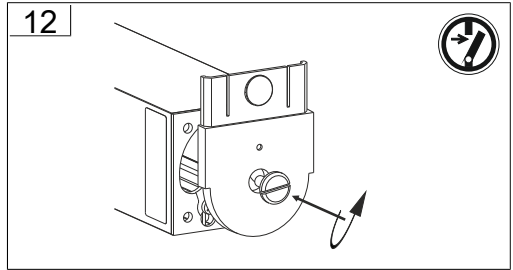
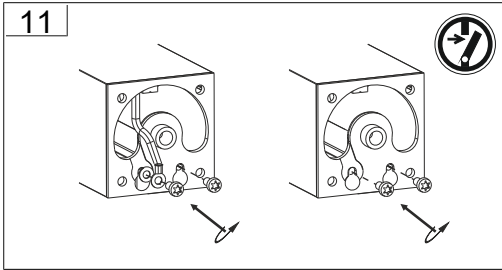

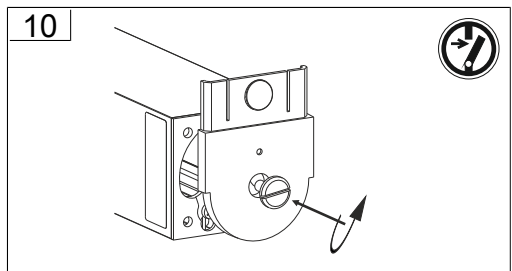
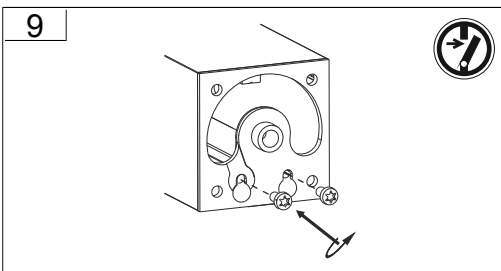
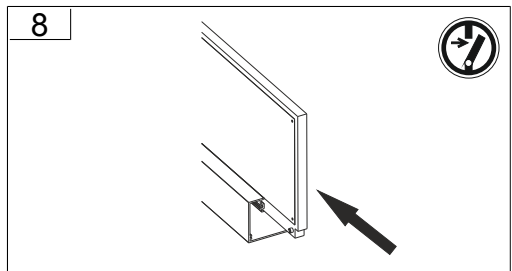
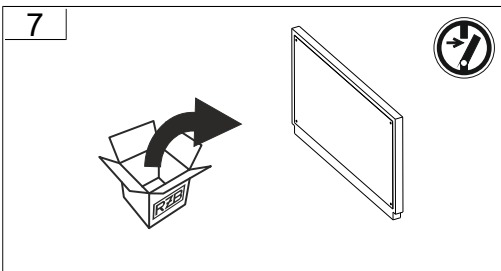
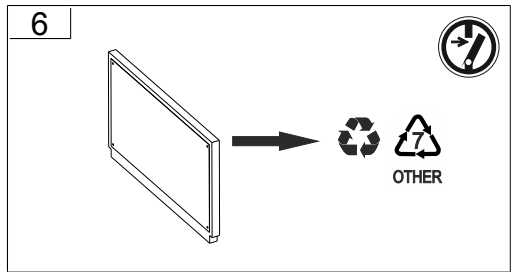
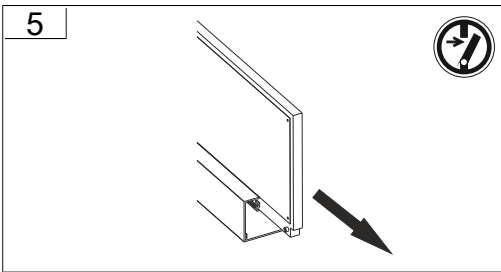
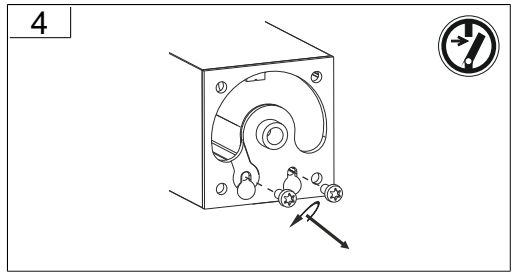
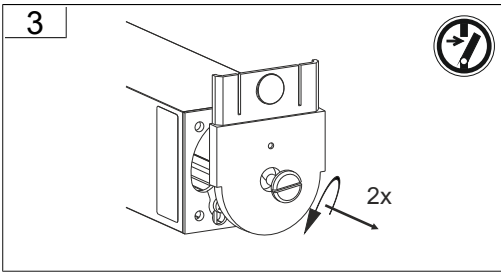
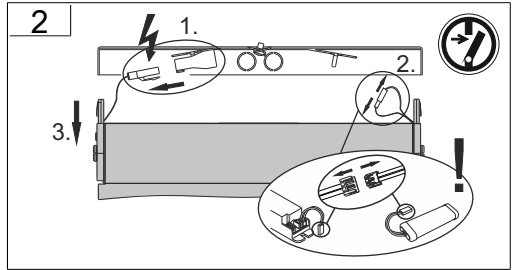
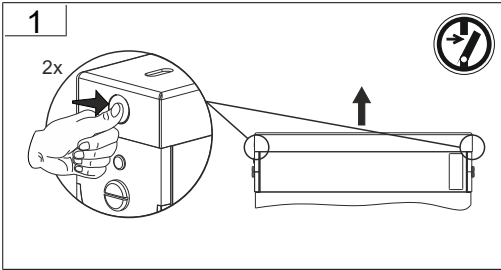

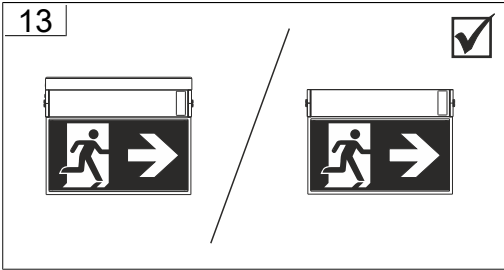
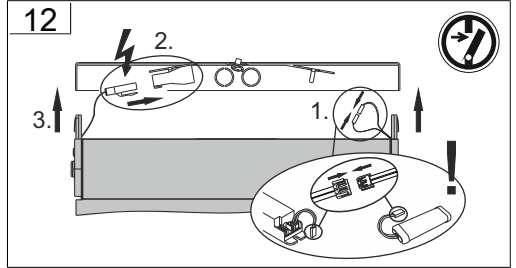
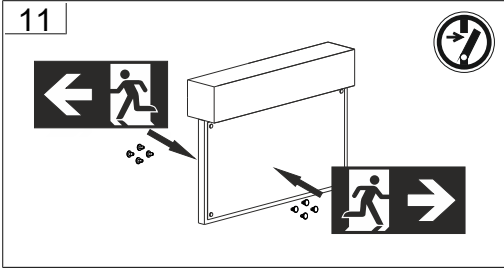

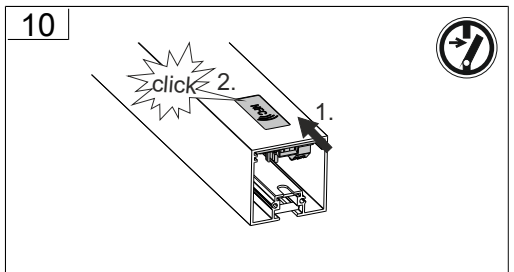
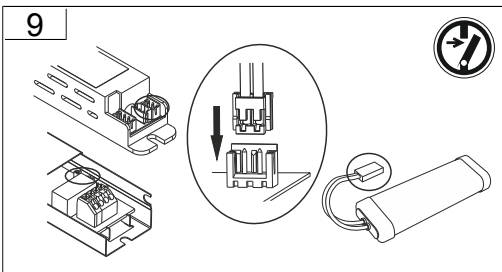
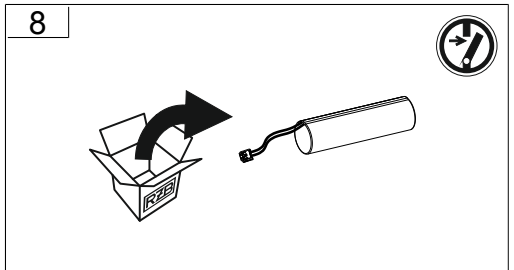
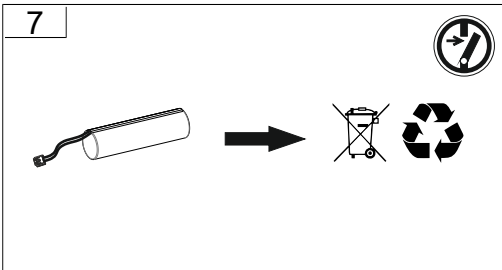
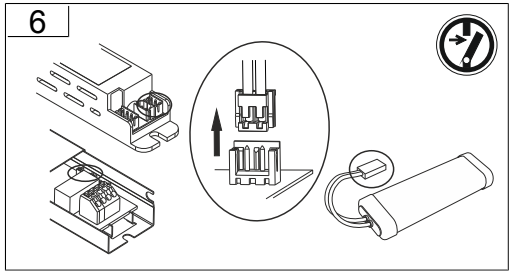
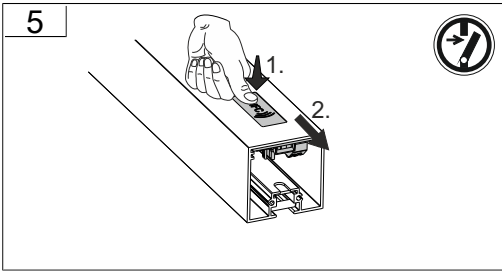
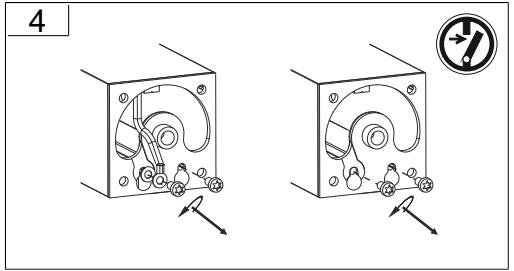
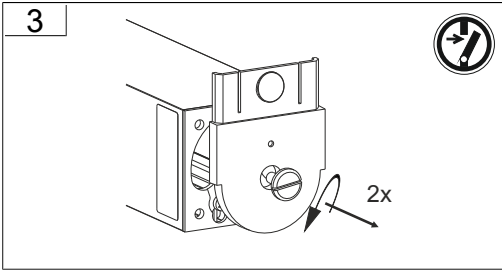
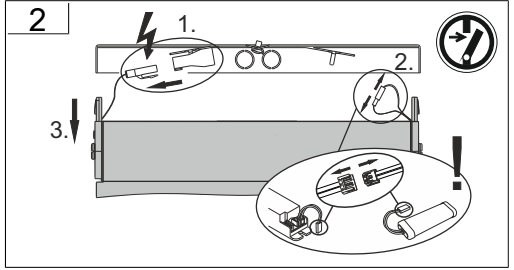
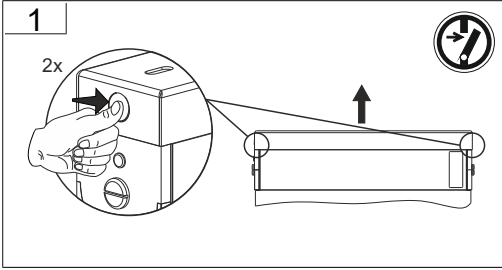
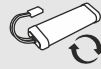

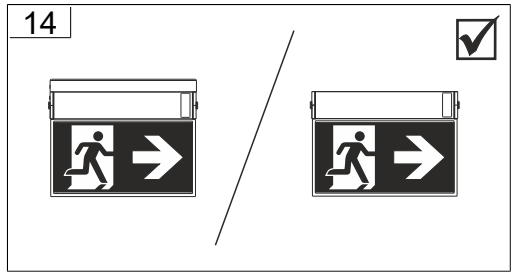
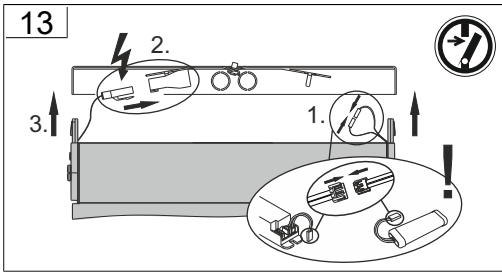
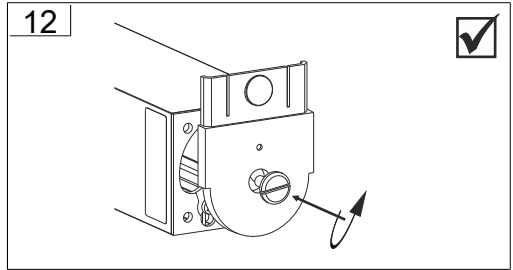
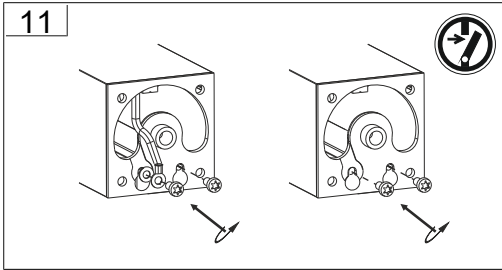
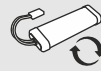

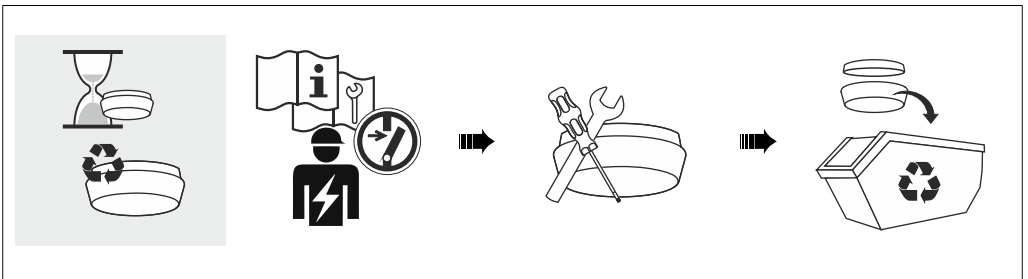
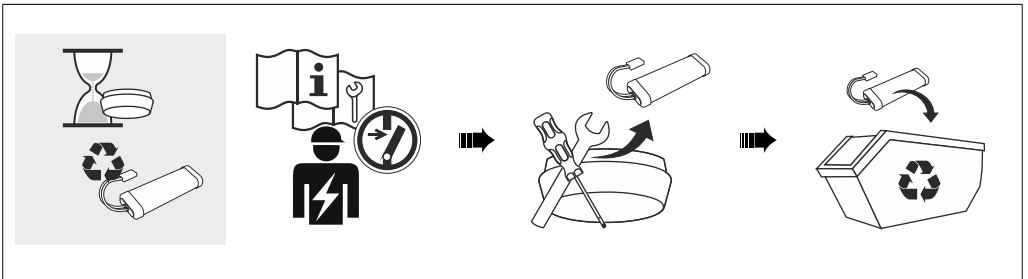
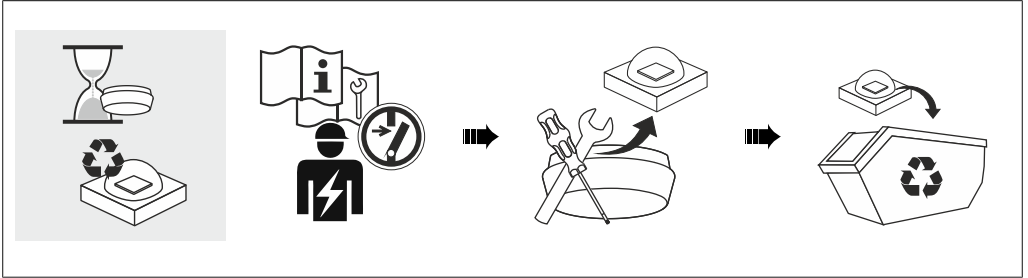

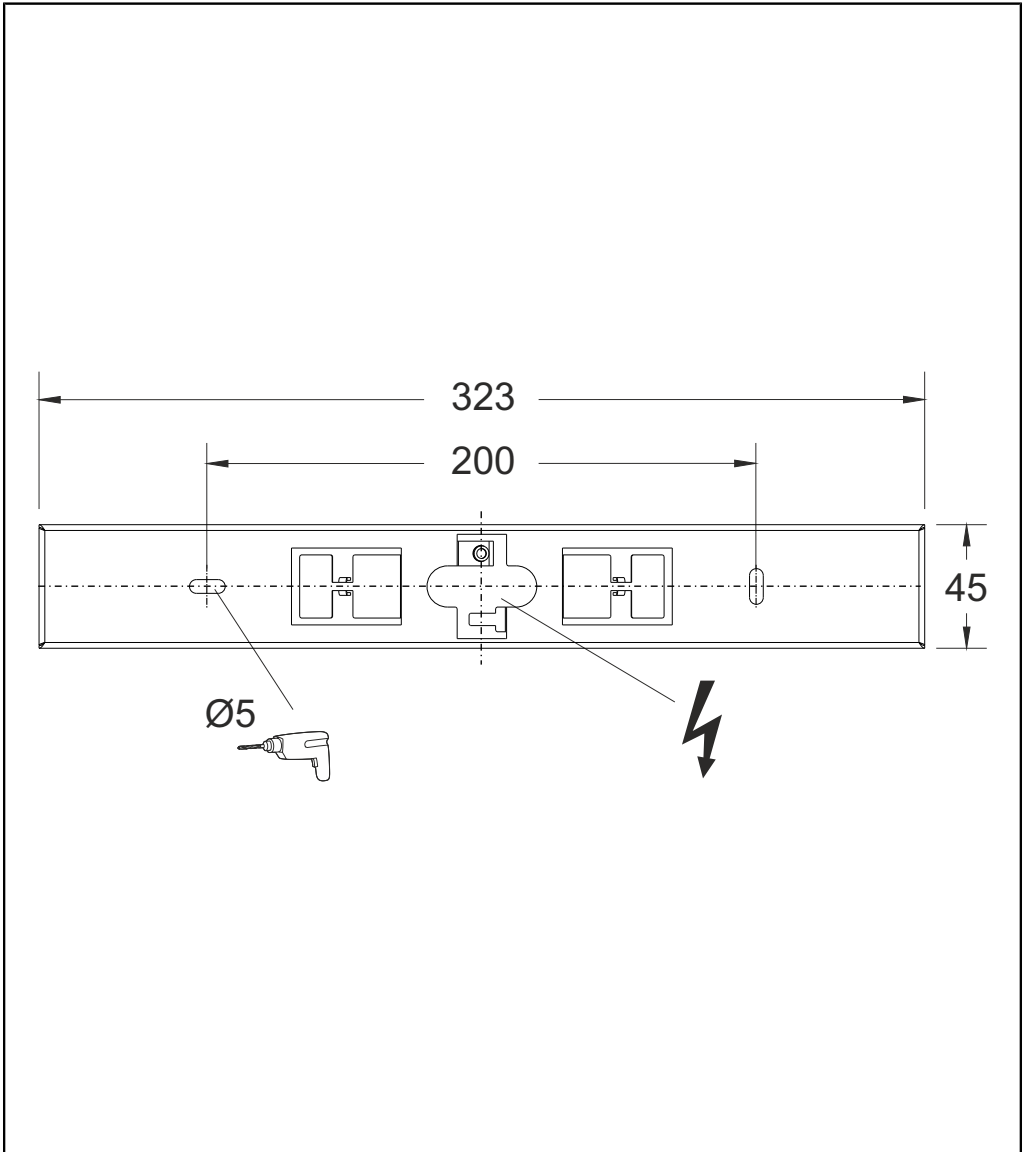



RZB - Rudolf Zimmermann, Bamberg GmbH

 Rheinstraße 16, 96052 Bamberg

 0951/7909-0

 0951/7909-198

 [info@rzb-leuchten.de](mailto:info@rzb-leuchten.de)