

# Product Data Sheet

## GW46406

46 Range



Accessories and complementary items for distribution and automation boards range 46.

For boards LxH (mm)	585x800	Suitable for	46QP - 46QM - 46QX
Type	Full	Type of material	Steel
Electrocod	0303		

### DIMENSIONAL

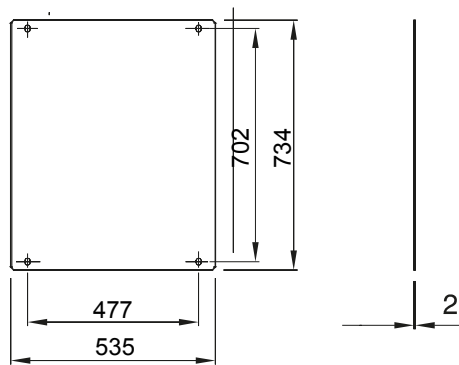

### STANDARDS/APPROVALS

