

Product Data Sheet

GW44648

46 Range

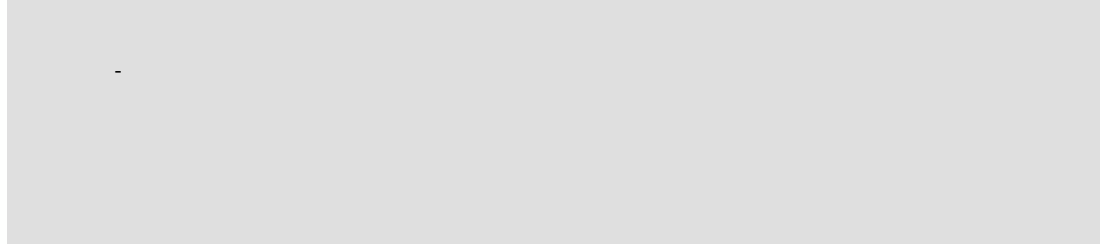
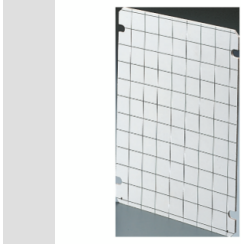

For boards LxH (mm)	316x396	For boards	44 CEP
Type of material	Insulation	Electrocod	1320

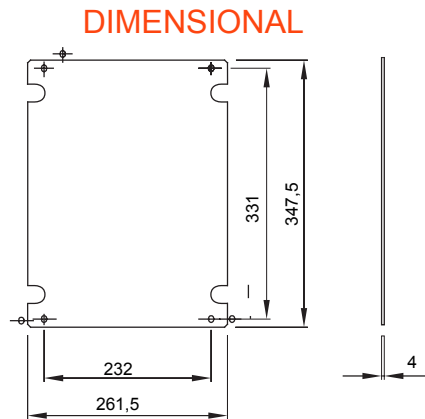

STANDARDS/APPROVALS

