

Product Data Sheet

DX51232

GW FIT Range

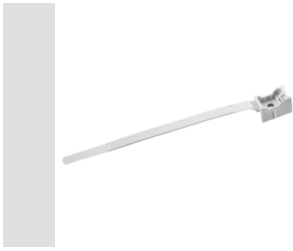

Systems of accessories for electrical installations used for residential, tertiary and industrial applications. The system consists of fasteners for pipes and cables, cable fittings, accessories for rigid pipes (RK Series) and flexible conduit (DF Series). The system include also a wide variety of cable ties (52FS Range) and terminal blocks (44 Range).

Colour	Grey RAL 7035	IP degree	-
Material	Polyamide	Conduits Ø (mm)	16-32
Description	Collar cannot be reopened	Glow Wire Test	750 °C
For external conduits (mm)	16-32	Operating temperature	-5 +60 °C
Type of material	Halogen-free in compliance with EN 60754-2	Electrocod	21221
Standard	EN 61386-1 (when applicable)		

DIMENSIONAL

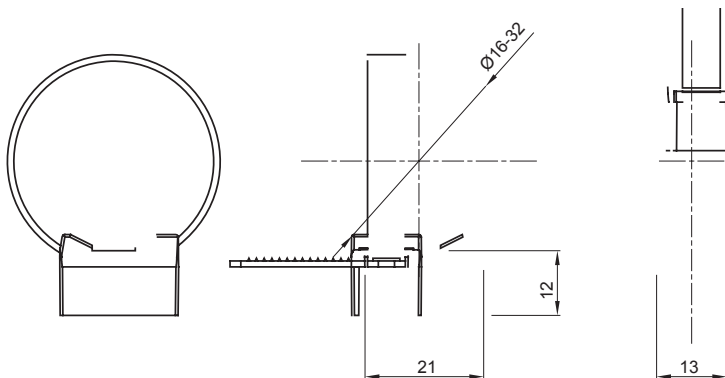

TECHNICAL SYMBOLOGY

IP

GWT

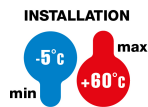

- 750 °C

STANDARDS/APPROVALS

