



0017555315050

# Altivar / Lexium

## VW3A7701...718

	$\Omega$	W			$\Omega$	W	
		40°C 104°F	50°C 122°F			40°C 104°F	50°C 122°F
VW3A7701	100	58	50	VW3A7710	2.75	28750	25000
VW3A7702	60	115	100	VW3A7711	2.10	42550	37000
VW3A7703	28	231	200	VW3A7712	2.10	50600	44000
VW3A7704	15	1154	1000	VW3A7713	1.80	17595	15300
VW3A7705	10	1154	1000	VW3A7714	1.41	24035	20900
VW3A7706	8	1154	1000	VW3A7715	1.05	64400	56000
VW3A7707	5	1154	1000	VW3A7716	1.05	86250	75000
VW3A7708	4	1154	1000	VW3A7717	0.70	128800	112000
VW3A7709	2.5	1154	1000	VW3A7718	0.70	172500	150000

### **⚠ ⚠ DANGER**

#### **HAZARD OF ELECTRIC SHOCK, EXPLOSION, OR ARC FLASH**

- Only appropriately trained persons who are familiar with and understand the contents of this manual and all other pertinent product documentation and who have received safety training to recognize and avoid hazards involved are authorized to work on and with this drive system. Installation, adjustment, repair, and maintenance must be performed by qualified personnel.
- The system integrator is responsible for compliance with all local and national electrical code requirements as well as all other applicable regulations with respect to grounding of all equipment.
- Many components of the product, including the printed circuit boards, operate with mains voltage. Do not touch. Use only electrically insulated tools.
- Do not touch unshielded components or terminals with voltage present.
- Motors can generate voltage when the shaft is rotated. Prior to performing any type of work on the drive system, block the motor shaft to prevent rotation.
- AC voltage can couple voltage to unused conductors in the motor cable. Insulate both ends of unused conductors of the motor cable.
- Do not short across the DC bus terminals or the DC bus capacitors or the braking resistor terminals.
- Before performing work on the drive system:
  - Disconnect all power, including external control power that may be present.
  - Place a "Do Not Turn On" label on all power switches.
  - Lock all power switches in the open position.
  - Wait 15 minutes to allow the DC bus capacitors to discharge. The DC bus LED is not an indicator of the absence of DC bus voltage that can exceed 800 Vdc.
  - Measure the voltage on the DC bus between the DC bus terminals (PA/+, PC/-) using a properly rated voltmeter to verify that the voltage is <42 Vdc.
  - If the DC bus capacitors do not discharge properly, contact your local Schneider Electric representative. Do not repair or operate the product.
- Install and close all covers before applying voltage.

**Failure to follow these instructions will result in death or serious injury.**

Electrical equipment should be installed, operated, serviced, and maintained only by qualified personnel. No responsibility is assumed by Schneider Electric for any consequences arising out of the use of this product.

© 2014 Schneider Electric. All Rights Reserved.

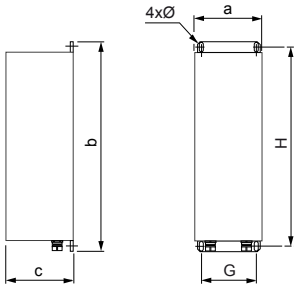

	a	b	c	G	H	Ø
	mm (in.)	mm (in.)	mm (in.)	mm (in.)	mm (in.)	mm (in.)
VW3A7701	95 (3.74)	293 (11.54)	95 (3.74)	70 (2.76)	275 (10.83)	6 x 12 (0.24 x 0.48)
VW3A7702	95 (3.74)	393 (15.47)	95 (3.74)	70 (2.76)	375 (14.76)	6 x 12 (0.24 x 0.48)
VW3A7703	140 (5.51)	393 (15.47)	120 (4.72)	120 (4.72)	375 (14.76)	6 x 12 (0.24 x 0.48)

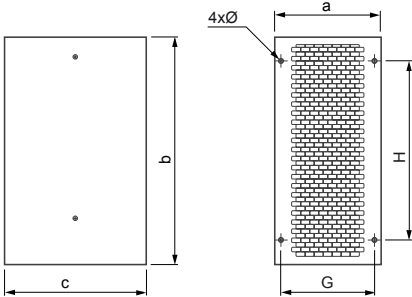

	a	b	c	G	H	Ø
	mm (in.)	mm (in.)	mm (in.)	mm (in.)	mm (in.)	mm (in.)
VW3A7704...709	240 (9.45)	484 (19.06)	301 (11.85)	210 (8.27)	380 (14.96)	9 (0.35)

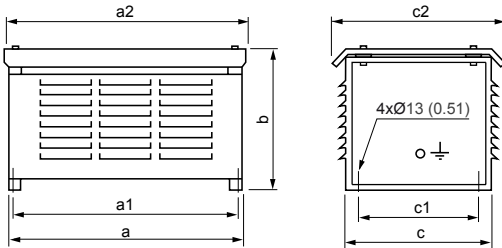

	a	b	c	a1	c1	a2	c2	
	mm (in.)	mm (in.)	mm (in.)	mm (in.)	mm (in.)	mm (in.)	mm (in.)	
VW3A7710	860 (33.86)	690 (27.17)	480 (18.90)	832 (32.76)	400 (15.75)	890 (35.04)	540 (21.26)	1 x
VW3A7711	960 (37.80)	1150 (45.28)	380 (14.96)	932 (36.69)	300 (11.81)	1140 (44.88)	460 (18.11)	
VW3A7712	860 (33.86)	1150 (45.28)	540 (21.26)	832 (32.76)	460 (18.11)	1040 (40.94)	620 (24.41)	
VW3A7713	760 (29.92)	440 (17.32)	480 (18.90)	732 (28.82)	400 (15.75)	790 (31.10)	540 (21.26)	
VW3A7714	960 (37.80)	440 (17.32)	480 (18.90)	932 (36.69)	400 (15.75)	990 (38.98)	540 (21.26)	
VW3A7715	960 (37.80)	1150 (45.28)	540 (21.26)	932 (36.69)	460 (18.11)	1140 (44.88)	620 (24.41)	
VW3A7716	960 (37.80)	1150 (45.28)	740 (29.13)	932 (36.69)	660 (25.98)	1140 (44.88)	820 (32.28)	
VW3A7717	960 (37.80)	1150 (45.28)	540 (21.26)	932 (36.69)	460 (18.11)	1140 (44.88)	620 (24.41)	2 x
VW3A7718	960 (37.80)	1150 (45.28)	740 (29.13)	932 (36.69)	660 (25.98)	1140 (44.88)	820 (32.28)	

VW3A7701 ...703

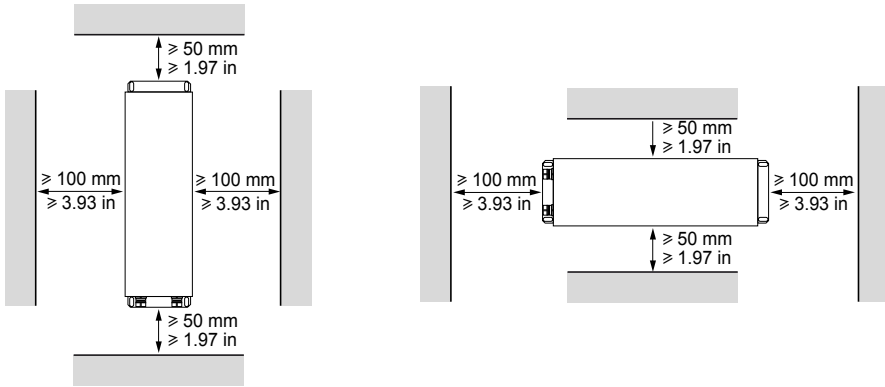

VW3A7704 ...709

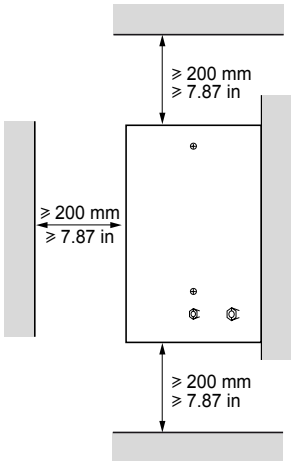

VW3A7710 ...718

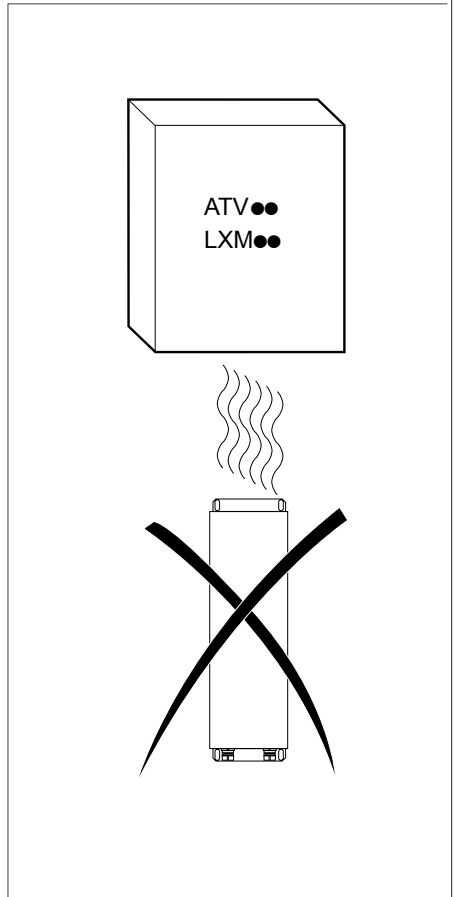
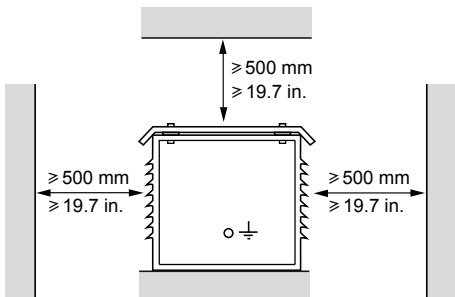

VW3A7701 ...703

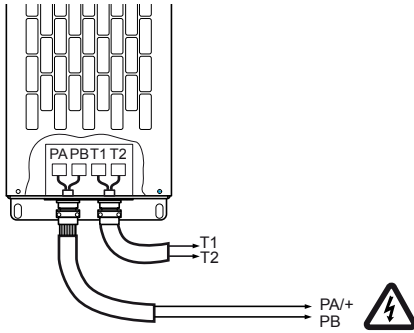

VW3A7704 ...709

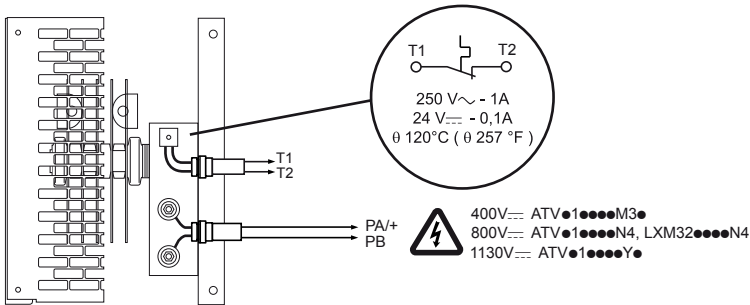

VW3A7710 ... 716 a    ATV●1●●●●●M3●    ATV●1●●●●●N4

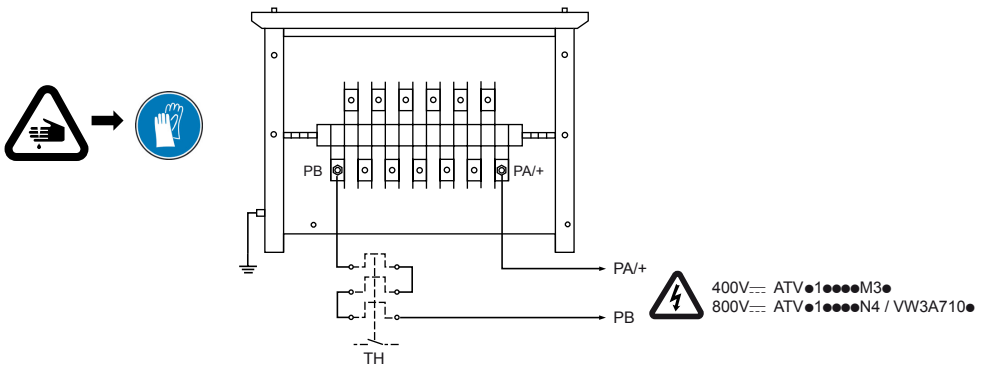

[1.8 -----] (FLt-) : brP-

www.schneider-electric.com

VW3 A7 716 ATV●1●●●●●Y

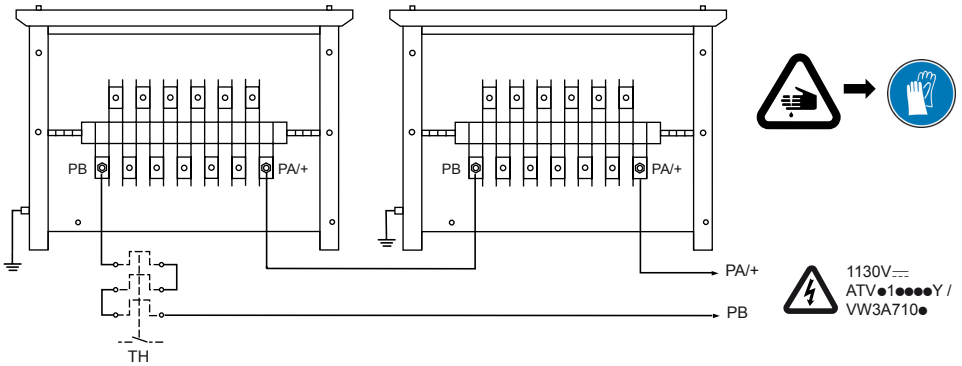

VW3A7717 - 718 ATV●1●●●●●M3● ATV●1●●●●●N4

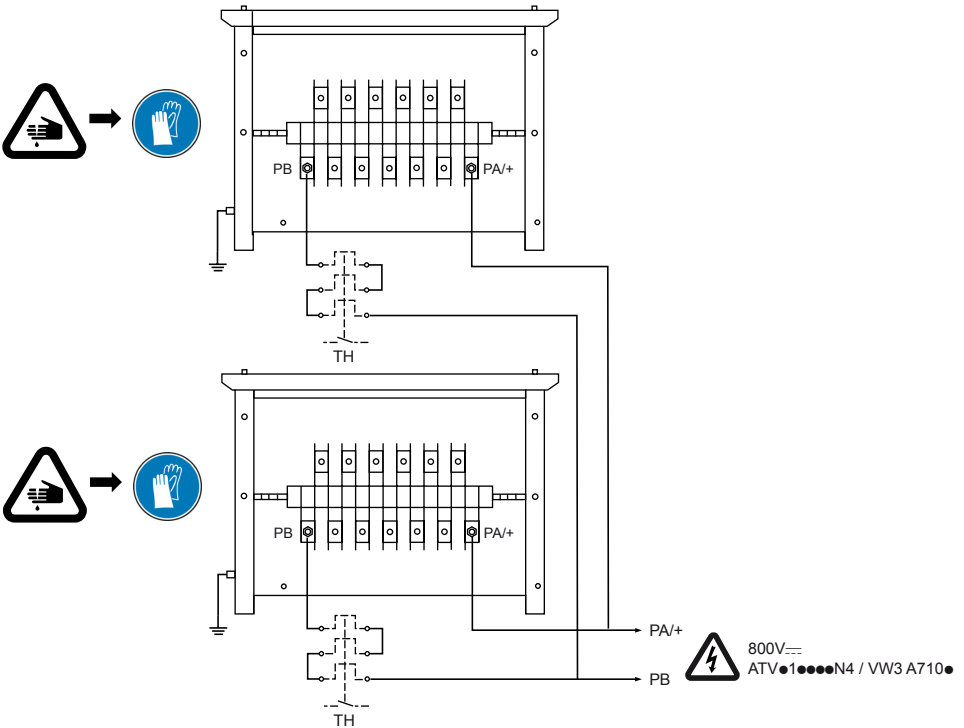

[1.8 -----] (FLt-) : brP-

www.schneider-electric.com

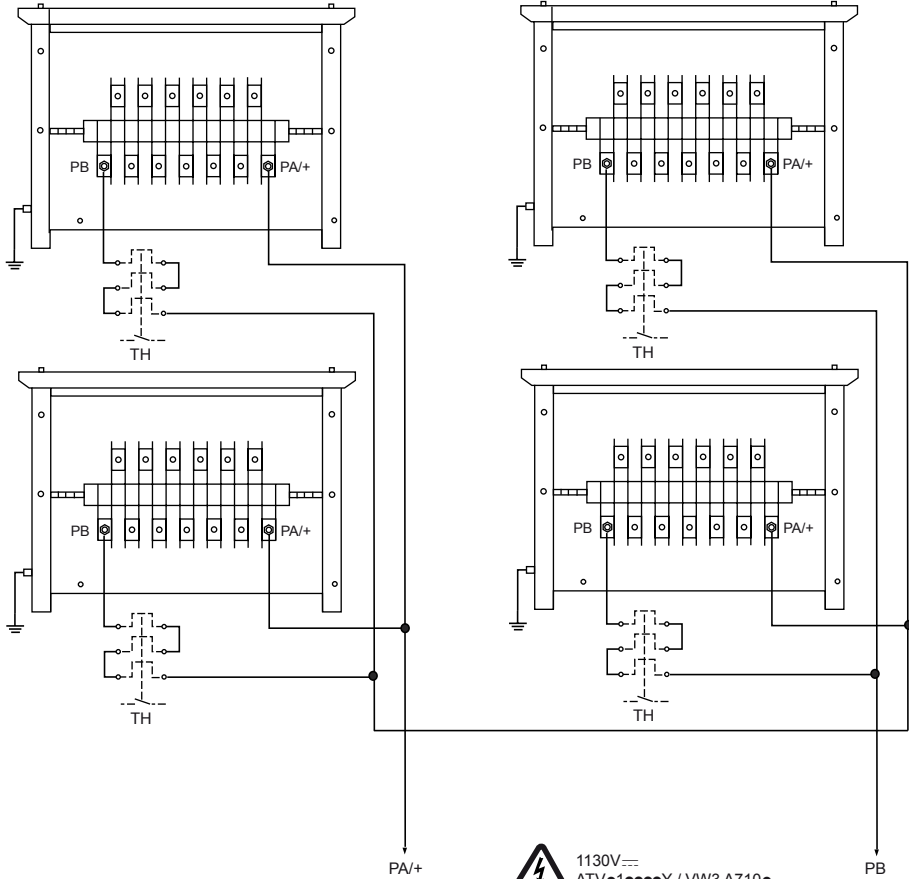

1130V ~ ~ ~  
ATV●1●●●●Y / VW3 A710●

[1.8 -----] (FLt-) : brP-

www.schneider-electric.com