

# Product Data Sheet

## GW38419

DATA CENTER range



Complete system for the connection and distribution of LAN networks in residential and tertiary sector environments. The range includes fibre optic solutions, wall panels, floor cabinets and copper wiring products. Data Center boards and cabinets are available in a wide choice of modularity and different depths (up to 1000 mm), for adapting to every application need.

Made with high quality materials (static flow at full load can reach 1000kg), the products are also characterised by their simple wiring (thanks to large internal volumes) and complete customisation, with removable and reversible front doors.

Category	19" wall-mount cabinet	Material	Steel
Finishing	Textured	Colour	Grey (RAL 7035)
Cabling unity	15 U	Type of door	Reversible
Door opening	180°	Static load capacity	50 Kilogram
No. uprights	2	Depth (mm)	600 mm
Outer dim. LxHxD (mm)	600x740x600	IP degree	IP20
Electrocod	3752		

### DIMENSIONAL

- 38 406
- 38 407
- 38 408
- 38 409
- 38 418
- 38 419

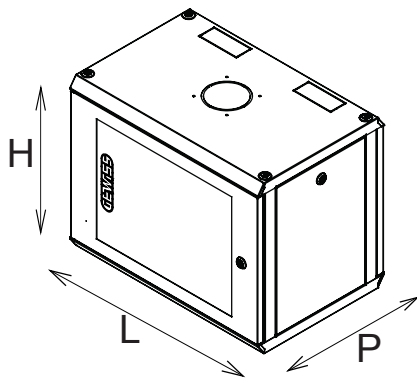

	H	L	P	

### TECHNICAL SYMBOLOGY

**IP**

IP20

### STANDARDS/APPROVALS

