

CONTENT	PAGE
■ 1. Use	2
■ 2. Technical features	2
2.1 Climatic features	2
2.2 Electrical features	2
2.3 Mechanical features	2
■ 3. Overall Dimensions	2
■ 4. Connection	2
■ 5. Operation	2
5.1 Switch	2
5.2 Relative dimming	3
5.3 Absolute dimming	3
5.4 Status Report	3
5.5 Scene	3
5.6 Preset Value	3
5.7 Staircase Lighting Function	3
5.8 Reset	3
5.9 Normal operation signs	3
■ 6. Standards and approvals	3
■ 7. Maintenance	3
■ 8. Communication objects	4
8.1 Introduction	4
8.2 Parameter Window "Device general"	4
8.3 Parameter Window "CH X active"	4
8.4 Parameter Window "CHX general"	4
8.5 Parameter Window: dimming general	5
8.5.1 Setting of "CH X dimming general"	5
8.5.2 Parameter Window "X: dimming"	6
8.5.3 Parameter Window "X: scene page"	7
8.5.4 Parameter Window "X: preset"	7
8.6 Staircase Lighting Mode	8
■ 9. Communication object description	8
9.1 Communication object of "Device General"	8
9.2 General communication object of "Dimming Actuator"	9
9.3 Scene function communication object of "Dimming Actuator"	9

**1. USE**

The KNX 1-10V dimmer ref. 0 026 88 allows 4 circuits 1-10V dimming control with a max absorption of 100mA per channel.

Through its application program the main possible functions are:

- switching/dimming
- configuration of normal/timer operating mode
- configuration of up to 15 scenes
- configuration of the behaviour upon reception of ON/dimming command
- configuration of dimming preset values

The KNX load switch ref. 0 026 88 is power supplied via the KNX BUS and does not need an external power supply.

**Note:**

Some lights cannot be turned off completely by dimming. In this case, you can turn off the lights via switching.

**2. TECHNICAL FEATURES**

**2.1 Climatic features**

- Ambient operating temperature: -5 °C to +45 °C
- Storage temperature: -25 °C to +55 °C
- Transport temperature: -25 °C to +70 °C
- Relative humidity except dewpoint : < 93 %

**2.2 Electrical features**

- KNX bus power supply: 29 V<sub>DC</sub>
- Current consumption ( BUS KNX ) :12 mA
- Outputs: 4 channels switching/dimming
- Output voltage: 1-10 V (max. 100 mA/channel)
- Connections: screw terminals, 2x2,5 mm<sup>2</sup>

**2.3 Mechanical features**

- Protection class (in accordance with standard EN 60529): IP20
- Weight: 400 g

**3. OVERALL DIMENSIONS**

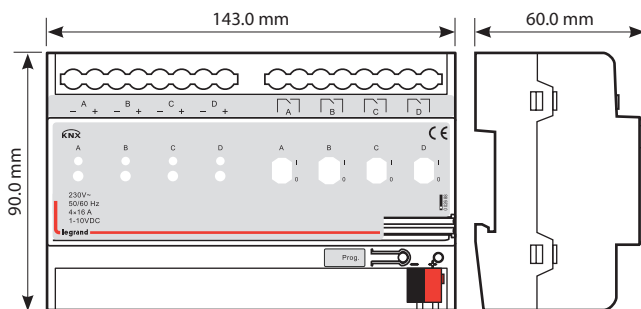

**4. CONNECTION**

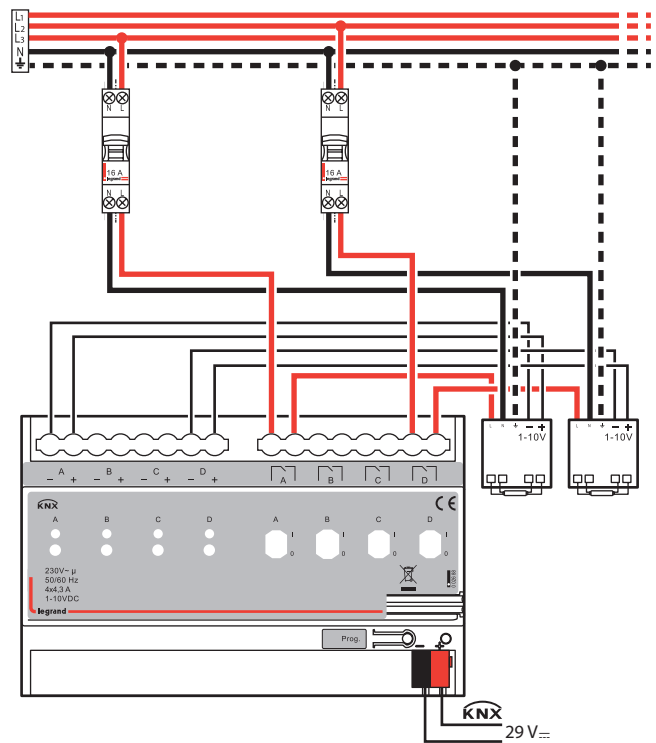

**5. OPERATION**

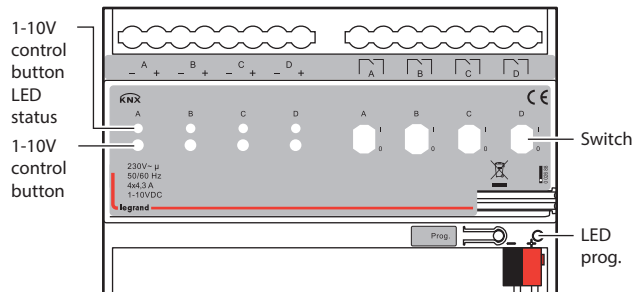

It is able to set different parameters to every output channel, and control various targets by modifying the setup of the internal parameters.

**5.1 Switch**

The output can be switched ON or OFF by 1 bit data. It is able to set the brightness value as the last one or a defined one (1%-100%) when switching on the luminaries. It is able to set a delay time (changing time) to dim UP the luminaries or dim UP gradually in the default period. When receiving the OFF message, the dimmer will be switched off immediately, or dim DOWN gradually after a delay time (changing time) or in the default changing period.

## 5. OPERATION (cont.)

### ■ 5.2 Relative dimming

4 data bits control: the relative dimming command means it is possible to dim UP or DOWN to the needed brightness value during the set brightness threshold range. It is only valid to dim UP when the brightness value is smaller than the low threshold value and dim DOWN when the brightness value is greater than the high threshold value. It is also able to set whether to switch on the luminaries by the message "dim UP to a certain value" when the output is 0 by this function. The relative dimming is used to control the relative changes of the brightness by 4 data bits: the lowest 3 bits are controlling-bit and the highest bit is----- "1" means dim UP, "0" means dim DOWN.

Explanation of setting relative dimming: (1-7: dim DOWN; 0-8 remain unchanged (stop dimming); 9-15 dim UP)

Parameter	0	1	2	3	4	5	6	7
Dim DOWN	Unchange/ stop dimming	255	128	64	32	16	8	4

Parameter	0	9	10	11	12	13	14	15
Dim UP	Unchange/ stop dimming	255	128	64	32	16	8	4

### ■ 5.3 Absolute dimming

8 data bits control: it is able to dim to the needed brightness value by changing the brightness parameters. The setting of the parameters is similar as relative dimming with the brightness value range: one low threshold value and one high threshold value. And it is not allowed to change the brightness value beyond the set range, the max. range is from 0 to 255. This function offers the possibility to dim UP or DOWN to 0 gradually to the target value by setting the delay time or the default time.

The high and low threshold value limits the total output of the dimmer; any brightness value beyond the range is not valid.

When the output is 0, it is able to set switching off the luminaries or remaining to a lower brightness value; and also in this status it is optional to switch on the luminaries by receiving the message "absolute dimming".

### ■ 5.4 Status Report

1 data bit: the dimmer offers the possibility whether sending the latest brightness value report of the controlled target and the changed report of the switch status to the BUS.

### ■ 5.5 Scene

8 data bits control: the dimmer offers 15 (1-15) scenes for selection. It is possible to set ONE brightness value and the gradual change time of ON for each scene. After setting, it is easy to call any favorite scene. 1 in the highest bit of the scene command it means "saving" command, to save the current brightness value to the relevant scene.

### ■ 5.6 Preset Value

The dimmer can preset scene, the object directly through 1bit data to transfer the preset scene or through 1bit data to let favorite scene to replace original preset scene. There are two preset values per output, there are two brightness values can be transfer for each preset value. Such as in theater, we need a relatively bright lighting effect when coming in, we can through transfer the first brightness value to be achieved this effect, when the movie starts playing, we need a relatively dark lighting effect, we can through transfer the second brightness value to be achieved. We can return to the previous brightness value when the movie ended.

## 5. OPERATION (cont.)

### ■ 5.7 Staircase Lighting Function

The dimmer offers the function of staircase lighting control besides the normal lighting control. The staircase lighting function serves to switch off the lighting directly until dimming DOWN to 20% of the brightness value after a set period. It is able to set the brightness of the luminaries, the duration of the light ON, the time to dim down to 20% separately. In this function, it uses 1 data bit control the targets directly by setting a permanent fixed value to the output of the staircase luminaries. The steps of staircase lighting control: the staircase luminaries will be switched on for a certain time (this time can be set) if the controlled target receives the message of "1"; these luminaries will be switched on again when receiving another message "1" during this period. The luminaries will be switched off when they are dimmed down to 20% of the brightness value (the dim down time can be set) after this period, or switch off the luminaries by sending message "0" to the controlled target. The luminaries will be off after dimming down to 20% when receiving the message "0" (the same dimming down time as above). When enabling the function "On reception switch OBJ=0 switch off", it is able to use the function "switch off" to turn off the output in the status of "permanent on", or change the status from "switch on" to "permanent on" (message "1" means ON, "0" means OFF).

### ■ 5.8 Reset

When the BUS is power off, all the outputs are switched off; the current brightness value will be saved to the memory of the dimmer. When the BUS voltage is recovered, the brightness status may be the last brightness value, or the preset brightness value. When the BUS is power off, it may have the following situation occurring: In the normal mode, 2 optional behaviors after the BUS voltage recovery are: the last brightness value before power off, or the set value. In the staircase lighting mode, the behavior after the BUS voltage recovery is: ON or OFF. No output when it is OFF; start the behavior "switch=1" when it is ON.

### ■ 5.9 Normal operation signs

1 bit data. The sign will be report periodically to the Bus when the dimmer is working normally.

## 6. STANDARDS AND APPROVALS

- EN 60669-2-1
- EN 50491-3
- EN 50491-5-1
- EN 50491-5-2
- Marking: KNX, CE

### Note:

All technical information is available at

 [www.legrandoc.com](http://www.legrandoc.com)

## 7. MAINTENANCE

Clean the surface with a cloth.  
Do not use acetone, tar-removing cleaning agents or trichloroethylene.

### Caution:

Always test before using other special cleaning products.

## 8. COMMUNICATION OBJECTS

### ■ 8.1 Introduction

2 operation modes (main function) per output:

#### • Normal Dimming

This mode is mainly used to control the normal luminaries system, which can set the output time and the brightness value of the dimmer, dim UP or DOWN with the function of "relative dimming", and also call the set brightness values from the scene function, until dim to the required environment.

#### • Staircase Lighting

The mode is mainly used to control the staircase luminaries. Switch ON the staircase luminaries and switch OFF automatically after a certain period, or switch OFF by manually.

### ■ 8.2 Parameter Window "Device general"

The parameter settings may have difference for different devices. If the device has not the follow parameters, it will have not the function of the parameter.

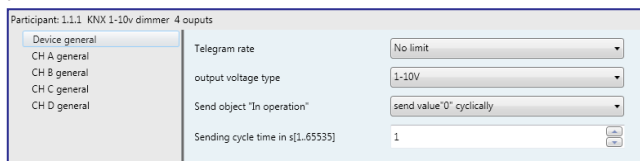

Fig. 6.1 Parameter window "Device general"

#### "Telegram rate"

This command is used to set the frame speed.

Options: No limit

Delay 100ms

Delay 200ms

...

Delay 700ms

In this system the function of frame speed is unavailable.

#### "output voltage type"

This parameter is used to set the output voltage type of 0/1-10V DC dimming controller.

Options: 0-10V

1-10V

#### "Send object "in operation"

This command is used to send messages "1" or "0" to the BUS periodically to check the device whether is working or not.

Options: No

Send value "0" cyclically

Send value "1" cyclically

It will not send any telegram with "No"; and show the following parameters with "Send value '0' cyclically" or "Send value '1' cyclically" to define the time interval of sending telegram.

#### "Sending cycle time in s[1...65535]"

This parameter defines the time interval of the telegram to report the normal working condition of the dimmer.

Options: 1...65535s

## 8. COMMUNICATION OBJECTS (cont.)

### ■ 8.3 Parameter Window "CH X active"

The parameter window of "CH X active" can be seen in Fig. 6.2, which activate or deactivate the output of Channel X. The "CH X" or "X" in the following text means any one output of the dimmers. The functions are describes as below and all the channels have them same functions setup.

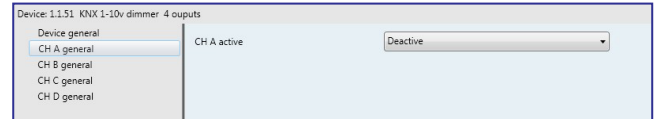

Fig. 6.2 Parameter window "CH X active"

#### "CH X active"

Options: Activated

Deactive

The window shown in Fig. 6.3 will pop out when choosing "Activated". In this window, it is able to set the working mode, the current brightness status and the switch status report. It will become null with "Deactive" selection.

### ■ 8.4 Parameter Window "CHX general"



Fig. 6.3 Parameter window "CH X general"

#### "Staircase lighting"

Options: Activated

Deactive

It is in the status of staircase lighting control with "Activated" and in the normal dimming control with "Deactive".

#### "Brightness value OBJ transmit after dimming"

This function is used to report the latest brightness value. When enable this function, it will send a frame to the BUS no matter what happen to make the brightness value changed.

Options: Nothing

Transmit new brightness

It will not send any report of the current brightness value with "Nothing". And send a frame to the BUS to report the current brightness value no matter what happens to make the brightness value changed with "Transmit new brightness".

#### Note:

if selected "transmit new brightness", the object "Brightness status X" and object "Brightness X" cannot be linked together by a same group address, or lead to the device internal loopback, and enter into endless loop, to make the bus system crash.

## 8. COMMUNICATION OBJECTS (cont.)

### 8.4 Parameter Window "CHX general" (cont.)

#### "Status report"

This function defines whether report the switch status to the BUS when the setup object "switch" is changed. Send "1" to the BUS when the current brightness value is greater than 0; send "0" when the value is equal to 0.

Options: Nothing  
It's new status

It will not send any report of the current switch status with "Nothing". And send a status changed report of switch to the BUS with "It's new status". Note: if selected "it's new status", the object "Switch status X" and object "Switch X" cannot be linked together by a same group address, or lead to the device internal loopback, and enter into endless loop, to make the bus system crash.

### 8.5 Parameter Window: dimming general

#### 8.5.1 Setting of "CH X dimming general"

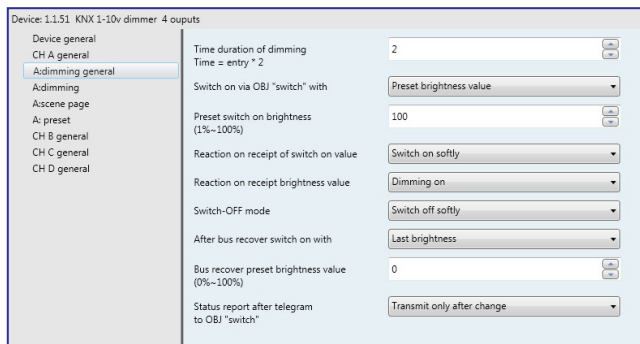

Fig. 6.4 Parameter window "CH X dimming general"

#### "Time duration of dimming time=entry\*2"

It is used to set the dimming time duration. No matter it is brightness dimming or switch dimming, when choosing the dimming time duration for dimming on or dimming off, the time is equal to this input value multiply 2 seconds, and the maximum input time is 255s.

#### "Switch on via OBJ "switch" with"

It is used to select the brightness value is the last one or the preset one when using the switch mode to switch on the luminaries.

Options: Preset brightness value  
Last brightness value

The option "Preset brightness value" means the brightness value is the preset value when switching on the luminaries by switch mode. When the brightness low threshold value is greater than the switch preset value, the brightness value of the luminaries is the low threshold value after switching on; when the switch preset value is greater than the high threshold, the brightness value is the high threshold one after switching on. The high and low threshold of the brightness are shown in the parameter window "CH X dimming", see Fig. 6.5.

The option "Last brightness value" means the brightness value is the last status' value which is not equal to 0. If the behavior of switching on the luminaries in switch mode after the BUS reset, and the luminaries during BUS reset are off, so the brightness value is the default brightness value 128; Other cases, the brightness value is the last status' value which is no equal to 0 on switching mode.

#### "Preset switch on brightness(1%~100%)"

It is used to set the brightness value when switch on the luminaries in switch mode, with the setting range 1%~100%.

## 8. COMMUNICATION OBJECTS (cont.)

### 8.5 Parameter Window: dimming general (cont.)

#### 8.5.1 Setting of "CH X dimming general" (cont.)

#### "Reaction on receipt of switch on value"

It shows the time duration to switch on the luminaries in switch mode.

Options: Dimming on  
Switch on softly

The option "Dimming on" means the switch dimming time is the input time multiplies 2. Then option "Switch softly" means the default dimming time is 4s.

#### "Reaction on receipt brightness value"

It is used to set the brightness value in the brightness dimming mode.

Options: Dimming on  
Switch on softly

The option "Dimming on" means the brightness dimming time is the input time multiplies 2. Then option "switch softly" means the default dimming time is 4s.

#### "Switch-off mode"

It shows the time duration to switch off the luminaries in switch dimming mode.

Options: Dimming off  
Switch off softly

Switch off instantly The option "Dimming off" means the switch dimming time is the input time multiplies 2. The option "switch softly" means the default dimming time is 4s. The option "switch off instantly" means the luminaries are switch off immediately.

#### "After bus recover switch on with"

It means in the normal situation, the behavior after the BUS reset is the brightness value before power off or the preset value.

Options: Preset brightness value  
Last brightness value

The option "Preset brightness value" means the brightness value after the BUS power recovers is the input preset brightness value in the "bus recover preset brightness value (0%~100%)". If the input preset value is smaller than the low threshold, the value after the BUS power recovery is the low threshold; if the preset input value is greater than the high threshold, the value after the BUS power recovery is the high threshold. The high and low threshold are shown in the parameter window "CH X dimming", see Fig. 6.5.

The option "Last brightness value" means the brightness value is the last value before power off after BUS power recovery. It also carry out a bus reset operation after downloading the parameters.

#### "Bus recover preset brightness value(0%~100%)"

It is used to set the brightness value during the BUS power recovery, and the range is 0%~100%

#### "Status report after telegram to obj "switch"

It is a backup parameter, do not care it.

## 8. COMMUNICATION OBJECTS (cont.)

## ■ 8.5 Parameter Window: dimming general (cont.)

## 8.5.2 Parameter Window "X: dimming"

Device: 1.151 KNX 1-10V dimmer 4 outputs

Device general  
CH A general  
Adimming general  
Adimming  
Ascene page  
A: preset  
CH B general  
CH C general  
CH D general

Relative dimming

Low dimming threshold  
1~127(0.4%~49.9%)

Upper dimming threshold  
128~255(50.2%~100%)

If dimming down and value  
≤ low dimming threshold output switch

Output switch on after receipt  
of dimming up telegram

Brightness value

Lower dimming threshold  
1~127(0.4%~49.9%)

Upper dimming threshold  
128~255(50.2%~100%)

If output on: receipt of "Brightness"  
value = 0" output switch

On receipt "Brightness Value" ≥ 1  
output switch on

Fig. 6.5 Parameter window "X: dimming"

This window is used to set the parameters in the brightness dimming mode. There are 2 type of brightness dimming mode: Relative dimming and Brightness value:

**Relative Dimming****"low dimming threshold 1~127~0.4% ~ 49.9%"**

This parameter defines the low threshold value of the relative dimming. When it is smaller than the low threshold, it is not allowed to dim DOWN, only to dim UP, the range is 1~127 (0.4% ~ 49.9%). Supposing the low threshold is 50, if the current brightness value is smaller than 50, so it is not allowable to dim DOWN until dimming UP to above 50.

**"upper dimming threshold 128~255 (50.2% ~ 100%)"**

This parameter defines the high threshold value of the relative dimming. When it is greater than the high threshold, it is not allowed to dim UP, only to dim DOWN, the range is 128~255 (50.2%~100%). Supposing the high threshold is 200, if the current brightness value is greater than 200, it is not allowable to dim UP until dim DOWN to below than 200.

**"If dimming down and value ≤low dimming threshold output switch"**

This parameter defines the action after relative dimming, whether it will be off or stay in the low threshold value.

Options: Off

To low threshold value

Supposing the low threshold is 50. If it is "Off", it will switch off the luminaries when dim DOWN to 50; if it is "To low threshold value", the value of the luminaries will remain the same even when dimming DOWN to 50. However, no matter whether it is "Off" or "To low threshold value", if the low threshold of the relative dimming is smaller than that of the brightness, it will switch off the luminaries automatically when dimming DOWN to the low threshold of the brightness value; if the high threshold of the brightness is less than relative high threshold, it is only possible to dim UP to the high threshold of the brightness. (The high and low threshold value will limit the total brightness value of the dimmer, see more details in the below description.)

## 8. COMMUNICATION OBJECTS (cont.)

## ■ 8.5 Parameter Window: dimming general (cont.)

## 8.5.2 Parameter Window "X: dimming"(cont.)

**"Output switch on after receipt of dimming up telegram"**

It tells that whether it is possible to switch on the luminaries when receiving the "dimming up" message from relative dimming if the output is 0.

Options: No

Yes

Supposing the current output is 0. If it is "NO", the output still remain 0 even when the target receives the message "dimming UP"; if it is "YES", it will dim the luminaries to the modified value when receiving the "dimming up" message. If the value after dimming up is smaller than the brightness low threshold, it will be dimmed to the low threshold directly. If the value after dimming up is greater than the brightness high threshold, it will be dimmed to the high threshold directly.

**Brightness Value**

The high and low threshold value limits the high and low output value. It is not allowed to change the brightness value if it is beyond the high and low threshold which will be invalid. For example in Fig. 6.5 the value is set as 1~255. If the low threshold value is set as 50 and the high threshold is 200, the brightness value "210" will be invalid. The luminaries will be dimmed from the low threshold directly when the brightness value goes up from 0; the luminaries will be dimmed from the high threshold directly when the brightness values goes down from 255.

**"lower dimming threshold 1~127~0.4% ~ 49.9%"**

This function defines the low threshold of the dimmer, and the range is 1~127. It is going to start dimming from the low threshold. Supposing the current brightness value is 0; the low threshold is 50 and the high threshold is 200. If receiving the message "30", the brightness value will go to 50 directly without gradual change; if receiving the message "60", so the brightness value will first go to 50 and then go up to 60 gradually; if the current value is 100 and the target value is 30, so the value will go from 100 to 50 and the brightness value is 50.

**"upper dimming threshold 128~255~50.2% ~ 100%"**

This function defines the high threshold of the dimmer, and the range is 128~255. Supposing the low threshold is 50, and the high threshold is 200. If the input brightness value is greater than 200, it will go to 200 directly.

**"If output on : receipt of "brightness value=0" output switch"**

This function defines it is available or not to switch off the output by the defined brightness vale "0".

Options: Off

To low threshold value

The option "Off" means the output is 0 when the brightness value is 0. The option "To low threshold value" means the output is the low threshold when the value is 0.

**"On receipt "brightness value" ≥ 1 output switch on"**

This function defines it is available or not to switch on the output by brightness dimming mode when the output is 0.

Options: No

Yes

The option "No" means the dimmer remains the output "0" when receiving the message of 100 if the output is 0. The option "Yes" means the output is the input brightness value when the receiving value is greater or equals to 1; if the input brightness value is smaller than the brightness low threshold, the output is the brightness low threshold.



## 8. COMMUNICATION OBJECTS (cont.)

### ■ 8.5 Parameter Window: dimming general (cont.)

#### 8.5.3 Parameter Window "X: scene page"

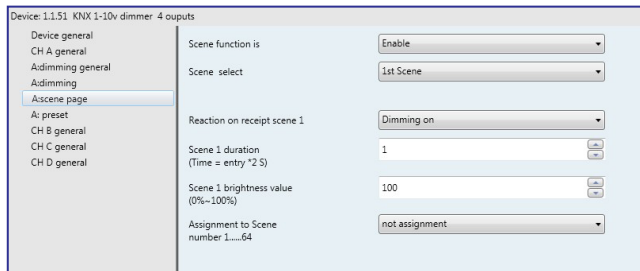

Fig. 6.6 parameter window "X: scene page"

This parameter shown in Fig. 6.6 defines the scene function, totally 15 scenes from 1 to 15. It is able to set 15 scenes simultaneously and call any one of them by control panel when needed.

#### "Scene function is"

The function defines the enable or disable of the scene function.

Options: Enable  
Disable

The option "Enable" means it is able to use the scene function of the dimmer X; the window shown in Fig. 6.6 will be displayed after selecting. If there is no need to use the function of scene, so select "Disable" option.

#### "Scene select"

This function is used to select a scene to set the brightness value, dimming time and dimming mode.

Options: Scene 1  
Scene 2  
...  
Scene 15

The setting parameters for the other 15 scenes are shown as below:

#### "Reaction on receipt scene Y"

The function defines the dimming mode of the set scene. Y means the scene that needs setting, 1~15. The Y shown as below has the same meaning.

Options: Dimming on  
Switch on softly

The option "Dimming on" means the set scene dimming time is the set time of the parameter "Scene Y duration (time=entry\*2s)"; the input time multiplies 2. The option "Switch on softly" means the scene dimming time is the default time "4S".

#### "Scene Y duration (time=entry\*2 S)"

This function defines the dimming time of the set scene, which is the input value multiplies 2s; the maximum input time is 255s.

#### "Scene Y brightness value (0%~100%)"

This function defines the brightness value of the set scene, with range from 1% to 100%.

## 8. COMMUNICATION OBJECTS (cont.)

### ■ 8.5 Parameter Window: dimming general (cont.)

#### 8.5.3 Parameter Window "X: scene page"(cont.)

##### "Assignment to Scene number 1...64"

This function distributes the scene number of the set scene that means the communication object "Scene/save X" will call the scene by the allocated scene number.

Options: Not assignment  
Assignment to scene 1  
Assignment to scene 2  
...  
Assignment to scene 64

Note: the parameter setting option is 1~64 field number or unallocated.

#### 8.5.4 Parameter Window "X: preset"

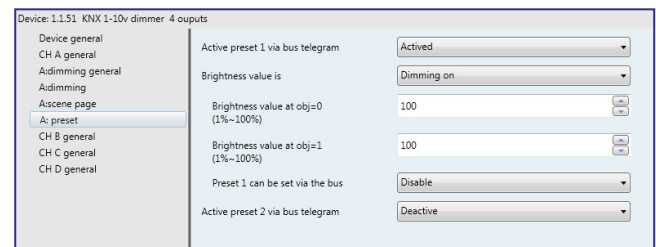

Fig. 6.7 parameter window "X: preset"

It is able to set the brightness value in "X: preset" shown in Fig. 6.7. There are two preset objects per output: "preset 1" and "preset 2" which are used to realize the lighting control. It is also able to save the current brightness status as the new preset value. These 2 preset values have the same parameters setup, so here take one as an example.

#### "Active preset 1 via bus telegram"

This parameter is used to activate preset 1.

Options: Active  
Desactive

It will not activate the preset 1 with "Desactive", and show the following parameter with "Active".

#### "Brightness value is"

This parameter defines the time when starting the dimming by "preset 1", and there is 1 bit data to control "X preset 1": "0" and "1", which is able to call 2 different brightness values.

Options: Dimming on  
Switching on softly

When select "dimming on", the dimming time of object "X preset 1" is the input time of "Time duration of dimming Time =entry" multiplied by 2; When select "switching on softly", the dimming time of "X preset 1" is the default value: 4 seconds.

#### "Brightness value at obj=0(1%~100%)"

This parameter defines the brightness value when receiving "0" by "X preset 1".

Option: 1~100%

#### "Brightness value at obj=1(1%~100%)"

This parameter defines the brightness value when receiving "1" by "X preset 1".

Option: 1~100%

## 8. COMMUNICATION OBJECTS (cont.)

### 8.5 Parameter Window: dimming general (cont.)

#### 8.5.4 Parameter Window "X: preset"(cont.)

##### "Preset 1 can be set via the bus"

This parameter defines the possibility to change the preset value. It is able to change the preset value with "enable" and also start the communication object "Set preset 1", which is used to save the current switch status as the new preset value. It will save the current brightness status to the "brightness value at obj=0" and replace that value with "0"; will save the current brightness status to the "brightness value at obj=1" and replace that value with "1".

Options: Enable  
Disable

##### "Active preset 2 via bus telegram"

This parameter is used to activate preset 2.

Options: Active  
Desactive

It will not activate the preset 2 with "Desactive", and show the following parameter with "Active".

### 8.6 Staircase Lighting Mode

It is able to set the parameters of staircase lighting mode in Fig. 6.8.

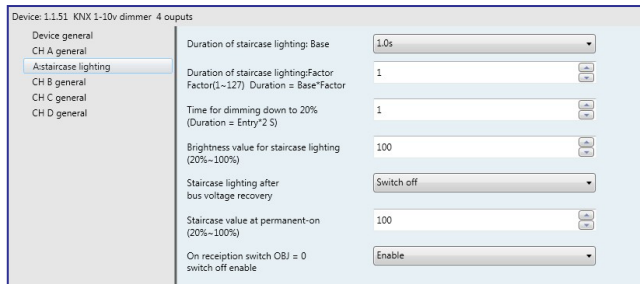

Fig. 6.8 parameter window "CH X staircase lighting"

#### "Duration of staircase lighting : Base"

Set the time of base: 1.0 s / 2.1 s / ... / 1.1 min / ... / 1.2 h

#### "Duration of staircase lighting : Factor"

Set the time of factor: 1~255 S

When switch on the staircase luminaries by "switch" mode, the ON duration time is:  $\text{duration} = \text{base} * \text{factor}$ . It will switch off the luminaries when the brightness goes down to 20% gradually after the ON duration time.

#### "Time for dimming down to 20% (Duration=Entry\*2)"

This function defines the time that the brightness value of the staircase lamps goes down to 20%:  $\text{Duration} = \text{Entry} * 2$ . The maximum input value is 255s.

The luminaries will be switched off when the brightness value of the staircase goes down to 20%.

#### "Brightness value for staircase lighting(20% ~ 100%)"

The function defines the brightness value of the staircase when switching on the luminaries by "switch" mode.

#### "Staircase lighting after bus voltage recovery"

The function defines the status of the staircase luminaries after the BUS power recovery.

Options: Switch on  
Switch off

## 8. COMMUNICATION OBJECTS (cont.)

### 8.6 Staircase Lighting Mode (cont.)

#### "Staircase lighting after bus voltage recovery" (cont.)

The option "Switch on" means switch on the staircase luminaries after the BUS power recovery;  $\text{duration} = \text{base} * \text{factor}$ . It is to use the parameter "Time for dimming down to 20% (Duration=Entry\*2)" to set the DOWN time.

The option "Switch off" means switch off the staircase lamps after the BUS power recovery.

#### "Staircase value at permanent-on(20% ~ 100%)"

The function defines the output status of the staircase luminaries as a fixed brightness value. It will not switch off the staircase luminaries without receiving the OFF message from "permanent on". "permanent on" is another output mode of the staircase luminaries. The DOWN time of turning off the luminaries is set by the parameter "Time for dimming down to 20% (Duration=Entry\*2)". It will switch off the luminaries when going down to 20%. The range is 20%~100%.

#### "On reception switch OBJ=0 switch off enable"

Options: Enable  
Disable

It is able to send off command out by "switch" no matter in switch or permanent on mode with "Enable"; but only stop outputting "Permanent on" by using "permanent on" to send OFF command in the "permanent on" lighting mode with "Disable".

#### Note:

In the switch output mode, it can start the "permanent on" output mode, but can't be performed the close operation of "permanent on" when you did not start the "permanent on" output mode.

## 9. COMMUNICATION OBJECT DESCRIPTION

Communication object is the media of devices on the bus communicate with other device, that is, just communication object can communicate with the BUS. The role of each communication objects as following. (Take 1 fold universal dimmer for example)

### 9.1 Communication object of "Device General"

There are 2 communication objects in "Device General" in Fig. 7.1 and functions are shown in table 7.1.

Number	Name	Object Function	Description	Group Addresses	Length	C	R	W	T	U	Data Type	Priority
0	OUTPUT A Switch A				1 bit	C	-	W	-	-	switch	Low
1	OUTPUT A Switch status A				1 bit	C	R	-	T	-	switch	Low
2	OUTPUT A Relative dimming A				4 bit	C	-	W	-	-	dimming control	Low
3	OUTPUT A Brightness A				1 Byte	C	-	W	-	-	percentage (0..100%)	Low
4	OUTPUT A Brightness status A				1 Byte	C	R	-	T	-	percentage (0..100%)	Low

#### Note:

"C" in "Flag" column in the below table means that the object has a normal link to the bus; "W" means the object value can be modified via the bus; "R" means the value of the object can be read via the bus; "T" means that a telegram is transmitted when the object value has been modified; "U" means that value response telegrams are interpreted as a write command, the value of the object is updated..

No.	Function	Object name	Data	Flags
45	In operate	In operate	1bit	C,T

This object is used to declare the working condition by sending '1' or '0' to the bus cyclically, which is enabled when selecting "send value '0' cyclically" or "send value '1' cyclically" in the parameter "Send object 'in operation'" and disabled when selecting "no". It will send '0' with option "send value '0' cyclically" and '1' with "send value '1' cyclically".



9. COMMUNICATION OBJECT DESCRIPTION (cont.)

9.2 General communication object of "Dimming Actuator"

Number	Name	Object Function	Description	Group Addresses	Length	C	R	W	T	U	Data Type	Priority
0	OUTPUT A Switch A				1 bit	C	-	W	-	-	switch	Low
1	OUTPUT A Switch status A				1 bit	C	R	-	T	-	switch	Low
2	OUTPUT A Relative dimming A				4 bit	C	-	W	-	-	dimming control	Low
3	OUTPUT A Brightness A				1 Byte	C	-	W	-	-	percentage (0..100%)	Low
4	OUTPUT A Brightness status A				1 Byte	C	R	-	T	-	percentage (0..100%)	Low

Fig. 7.2 General communication object for each channel

No.	Function	Object name	Data	Flags
1, 12, 23, 34, A, B, C, D	Switch status	OUTPUT X	1bit	CRT

This object is used to report the status of the current switch to the bus. The dimmer will send '1' to the bus when the value of the brightness is larger than 0, to the bus with '0' value of '0'. The object will be enabled when selecting "It is new status" in the parameter "Status report".

No.	Function	Object name	Data	Flags
0, 11, 22, 33	Switch X	OUTPUT X	1bit	WC

This object is used to receive the switch command to switch the dimmer actuator. It will switch on the dimmer actuator with '1', off with '0'.

No.	Function	Object name	Data	Flags
4, 15, 26, 37	Brightness status X	OUTPUT X	1byte	CRT

This object is used to send the brightness status of the current output to the bus whatever causes the changes of the value. The object will be enabled when selecting "Transmit new brightness" in the parameter "Brightness value OBJ transmit after dimming".

No.	Function	Object name	Data	Flags
3, 14, 25, 36	Brightness X	OUTPUT X	1byte	WC

It is used to receive the brightness value to switch the dimmer actuator, switching on the actuator when the received value is larger than 0, off or stay to the lower threshold value with '0', which is defined by the parameter setup in the brightness value dimming.

No.	Function	Object name	Data	Flags
2, 13, 24, 35	Relative dimming X	OUTPUT X	4bit	WC

This object is used to dim up or down the outputs. It will dim down the input value is from 1 to 7. During this range, smaller amplitude of when dimming down with larger value; that means it will dim down to the biggest amplitude with 1, while to the smallest amplitude with 7, and 0 means stop dimming down. It will dim up when the input value is from 9-15. During this range, smaller amplitude of dimming up with larger value; that means it will dim up to the biggest amplitude with 9, while to the smallest amplitude with 15, and 8 means stop dimming up.

Table 7.2 General communication object table for each channel

9.3 Scene function communication object of "Dimming Actuator"

Number	Name	Object Function	Description	Group Addresses	Length	C	R	W	T	U	Data Type	Priority
6	OUTPUT A Scene / save A				1 Byte	C	-	W	-	-		Low

Fig. 7.3 Scene function communication object

No.	Function	Object name	Data	Flags
6, 17, 28, 39	Scene/Save X	OUTPUT X	1Byte	WC

This object is used to send an 8bit command to transfer or save the scene. This object is opening when on enable scene function. The mean of 8bit as following: Set up an 8bit command (binary code) as: FXNNNNNNNo.

F: '0' transfer scene; F: '1' save scene;  
X: Un-used, not affect the results;  
NNNNNN: scene number (0...63)  
The parameter setup is 1-64.

Table 7.3 Scene function communication object

9. COMMUNICATION OBJECT DESCRIPTION (cont.)

9.4 Preset value function communication object "Dimming Actuator"

Number	Name	Object Function	Description	Group Addresses	Length	C	R	W	T	U	Data Type	Priority
10	OUTPUT A Set preset 2				1 bit	C	-	W	-	-	switch	Low
9	OUTPUT A A Preset 2				1 bit	C	-	W	-	-	switch	Low
8	OUTPUT A Set preset 1				1 bit	C	-	W	-	-	switch	Low
7	OUTPUT A A Preset 1				1 bit	C	-	W	-	-	switch	Low
3	OUTPUT A Brightness A				1 Byte	C	-	W	-	-	percentage (0..100%)	Low

Fig.7.4 preset function communication object

No.	Function	Object name	Data	Flags
7, 18, 29, 40	X preset 1	OUTPUT X	1bit	WC

It is the communication object of preset 1 and call the preset value. When the object receives the logical value of '0', the brightness value of dimming are defined by "Brightness value at obj=0"; when the object receives the logical value of '1', the brightness value of dimming are defined by "Brightness value at obj=1". This object will be started after activating preset1.

No.	Function	Object name	Data	Flags
8	Set preset 1	OUTPUT X	1bit	WC

This object is used to modify brightness value of preset1. It will start parameter "preset1 can be set via the bus" with "Enable". Via this object can save current brightness status as new preset value. It will save the current brightness value to "brightness value at obj=0" with '0', that is to replace the is value; it will save the current brightness value to "brightness value at obj=1" with '1', that is to replace the is value.

No.	Function	Object name	Data	Flags
9, 20, 31, 42	X preset 2	OUTPUT X	1bit	WC

It is the communication object of preset 2 and calls the preset value. When the object receives the logical value of '0', the brightness value of dimming are defined by "Brightness value at obj=0"; when the object receives the logical value of '1', the brightness value of dimming are defined by "Brightness value at obj=1". This object will be started after activating preset 2.

No.	Function	Object name	Data	Flags
10, 21, 32, 43	Set preset 2	OUTPUT X	1bit	WC

This object is used to modify brightness value of preset 2. It will start the parameter "preset 2 can be set via the bus" with "Enable". Via this object can save current brightness status as new preset value. It will save the current brightness value to "brightness value at obj=0" with '0', that is to replace the is value; It will save the current brightness value to "brightness value at obj=1" with '1', that is to replace the is value.

Form 7.4 Preset value function communication object

9.5 Staircase Lighting Function communication object of "Dimming Actuator"

Number	Name	Object Function	Description	Group Addresses	Length	C	R	W	T	U	Data Type	Priority
5	OUTPUT A Permanent on A				1 bit	C	-	W	-	-	enable	Low
0	OUTPUT A Switch A				1 bit	C	-	W	-	-	switch	Low

Fig. 7.5 Staircase Lighting Function communication object

No.	Function	Object name	Data	Flags
0, 11, 22, 33	Switch X	OUTPUT X	1bit	CW

The communication object is used to switch the staircase light function of dimmer. It will switch off the The communication object is used to switch the staircase light function of dimmer. It will switch off the staircase lighting after a certain on time, and the starting staircase lighting time are defined by "Duration of staircase lighting: Base" and "Duration of staircase lighting: Factor" and lights on duration is: duration=base\*factor. It will be off automatically after some time. It will switch off the lights with '0'.

No.	Function	Object name	Data	Flags
5, 16, 27, 38	Permanent on X	OUTPUT X	1bit	CW

The object receives the logical value '1' to open staircase light for a long time, receives the logical value '0' to end the staircase light.

Form 7.5 Staircase Lighting Function communication object