

Esmi Impresia Base with Sounder Beacon

Instruction Sheet
R10207GB0

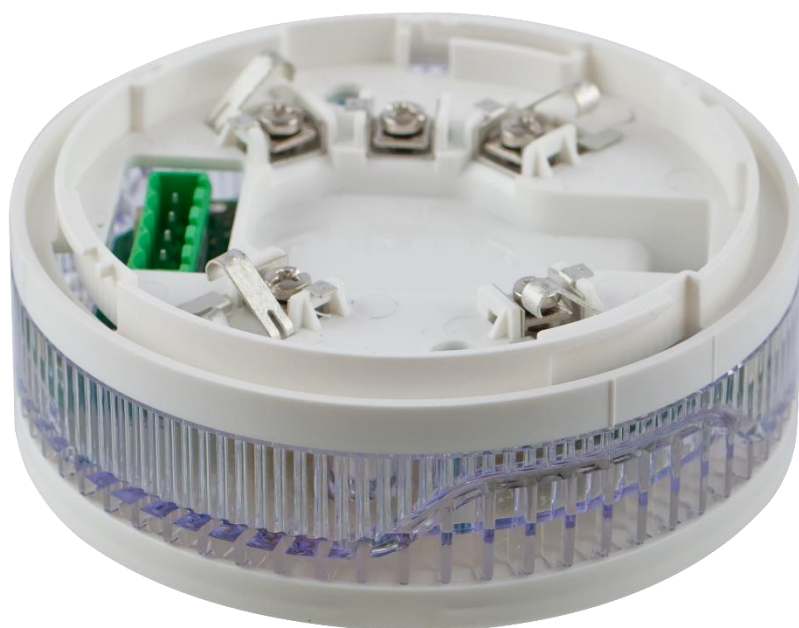

Schneider Electric Fire & Security Oy

Sokerilinnantie 11 C
FI-02600 Espoo, Finland
Tel: +358 10 446 511
Website: www.se.com
Document number: R10207GB0
Published: 18.012.2020

© 2020 – Schneider Electric. All Rights Reserved. This information is only to be used as guidance. Subject to changes and errors.

1 Esmi Impresia Base with Sounder Beacon

Esmi Impresia Base with Sounder Beacon (FFS06741017) is an addressable fire base with built-in sounder, strobe and an isolator module in its body. The fire base is designed for installing in addressable fire alarm systems with Esmi ELC loop controller supporting Schneider Electric communication protocol. The addressable Esmi Impresia Base with Sounder Beacon fire base supports 32 different tone types at two sound levels. The device is compatible for operation with Esmi Impresia addressable detectors series: Esmi Impresia Heat Detector (FFS06741002), Esmi Impresia Smoke Detector (FFS06741001) and Esmi Impresia Multicriteria Detector (FFS06741003). The device is designed for easy installation and consists from two parts: a mounting plane basis and sounder as a body with a factory mounted fire base. EN54-3 for indoor use.

The address setting is done by the panel or handheld addressing device. The address range is 1-250.

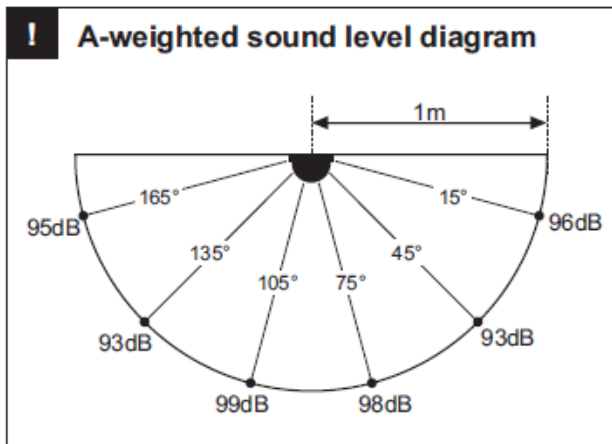

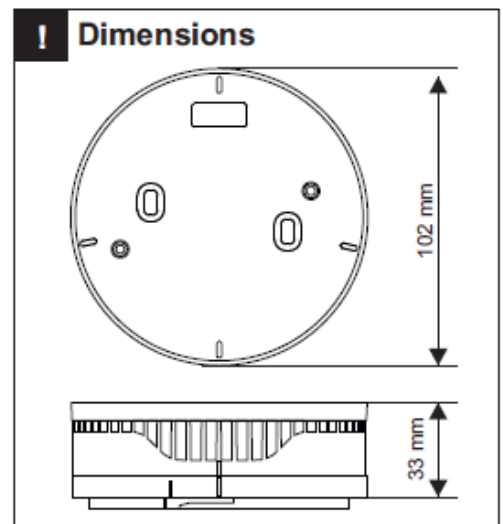

 1293
 DOP: DP20033
 Made in Bulgaria
 EN 54-3:2001
 EN 54-3:2001/A1:2002
 EN 54-3:2001/A2:2006
 EN 54-17:2005
 EN 54-17:2005/AC:2007
 Sounder Type: A



Installation

































 **IP21C***
 * With mounted detector

 Indoor use

 **-10°C ÷ +55°C**

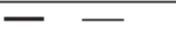
 **~127g**

1.1 Supported Tone Types and Description

Tone	Tone Type	Tone Description / Application
1		970Hz
2		800Hz/970Hz @ 2Hz
3		800Hz - 970Hz @ 1Hz
4		970Hz 1s OFF/1s ON
5		970Hz, 0.5s/ 630Hz, 0.5s
6		554Hz, 0.1s/ 440Hz, 0.4s (AFNOR NF S 32 001)
7		500 - 1200Hz, 3.5s/ 0.5s OFF (NEN 2575:2000)
8		420Hz 0.625s ON/0.625s OFF (Australia AS1670 Alert tone)
9		500 - 1200Hz, 0.5s/ 0.5s OFF x 3/1.5s OFF (AS1670 Evacuation)
10		550Hz/440Hz @ 0.5Hz
11		970Hz, 0.5s ON/0.5s OFF x 3/ 1.5s OFF (ISO 8201)
12		2850Hz, 0.5s ON/0.5s OFF x 3/1.5s OFF (ISO 8201)
13		1200Hz - 500Hz @ 1Hz (DIN 33 404)
14		400Hz
15		550Hz, 0.7s/1000Hz, 0.33s
16		1500Hz - 2700Hz @ 3Hz
17		750Hz
18		2400Hz
19		660Hz
20		660Hz 1.8s ON/1.8s OFF
21		660Hz 0.15s ON/0.15s OFF
22		510Hz, 0.25s/ 610Hz, 0.25s
23		800/1000Hz 0.5s each (1Hz)
24		250Hz - 1200Hz @ 12Hz
25		500Hz - 1200Hz @ 0.33Hz
26		2400Hz - 2900Hz @ 9Hz
27		2400Hz - 2900Hz @ 3Hz (2500Hz - main sound frequency) <i>Note: Approved to EN54-3 only!</i>
28		800Hz - 970Hz @ 100Hz
29		800Hz - 970Hz @ 9Hz
30		800Hz - 970Hz @ 3Hz
31		800Hz, 0.25s ON/ 1s OFF
32		500Hz - 1200Hz, 3.75s/0.25s OFF (AS2220)

1.2 Installation

Attention: Turn power off the loop circuit before installing the base!

1. Choose the proper place for installation of the device.
2. Set the module address using programmer or directly from addressable fire panel.
3. Fix the mounting plane basis on the ceiling of the protected premises using fixings according the mounting surface.
4. Run the loop wires and fix the sounder and strobe common body to the mounting basis using the supplied screws in the spare parts kit.
5. Connect the fire base to the fire panel using the wiring diagram.
6. Insert a detector - Esmi Impresia Heat Detector (FFS06741002), Esmi Impresia Smoke Detector (FFS06741001) and Esmi Impresia Multicriteria Detector (FFS06741003) - into the fire base and rotate clockwise until it drops into place - the short mark on the base fits with that on the sounder body. Continue to rotate the detector until its mark coincides with the long mark on the base - a click is heard.
Note: The mounted detector on the Esmi Impresia Standard Base (FFS06741018) with sounder is assigned at different address to the control panel!!
7. Program the sounder parameters.
8. Test the sounder for proper operation.

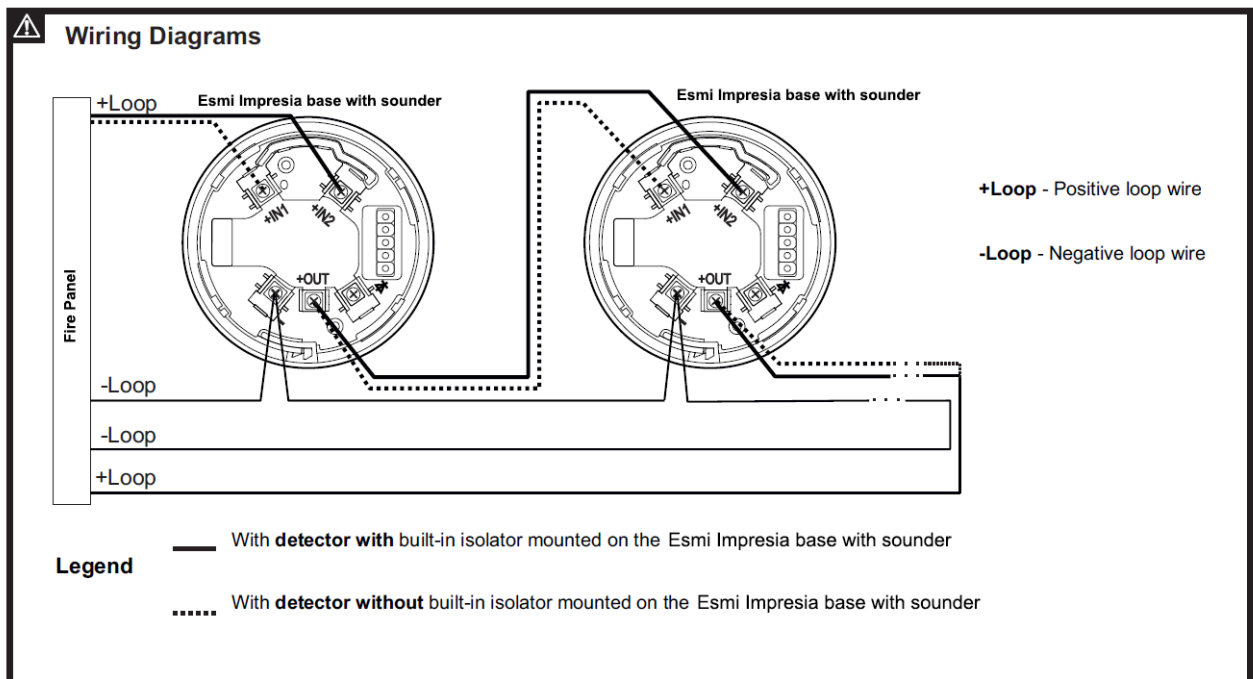

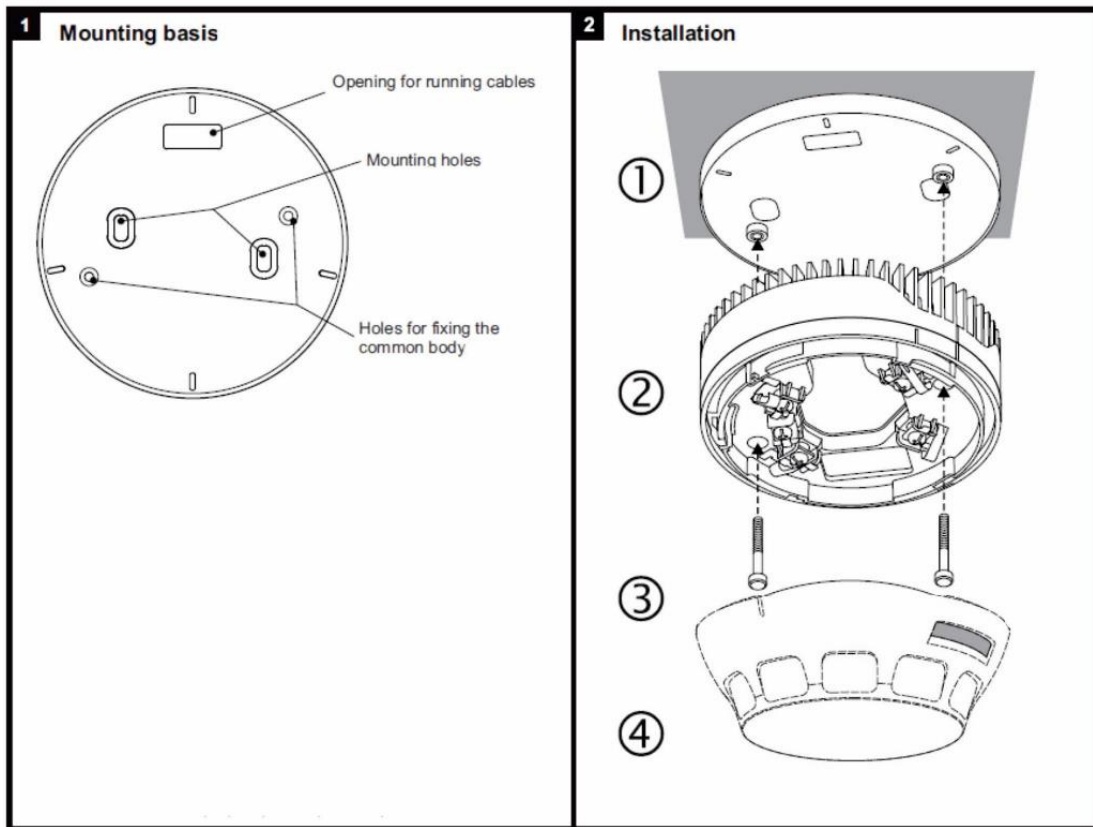

1.3 Spare parts

FFS06741023	Esmi Impresia Plastic Lid Set of 5 pcs
-------------	--