

	100 - 240 V~
	50 / 60 Hz
	2 x 2,5 mm ²
	-5°C / +45°C
	PIR
	500 lux
	15 mn
	Ø 8 m



230 V~	2000 W	1000 VA	10 x (2x36W)	4,3 A	500 VA	2,1 A	1000 VA	4,3 A	500 VA	I max. ≤ 2A
110 V~	1000 W	500 VA	5 x (2x36W)	4,3 A	250 VA	500 VA	250 VA	2,1 A		



230 V~	500 VA	2 A	I max. ≤ 2A
110 V~	500 VA		
U ≤ 30 V=	2 A maxi		

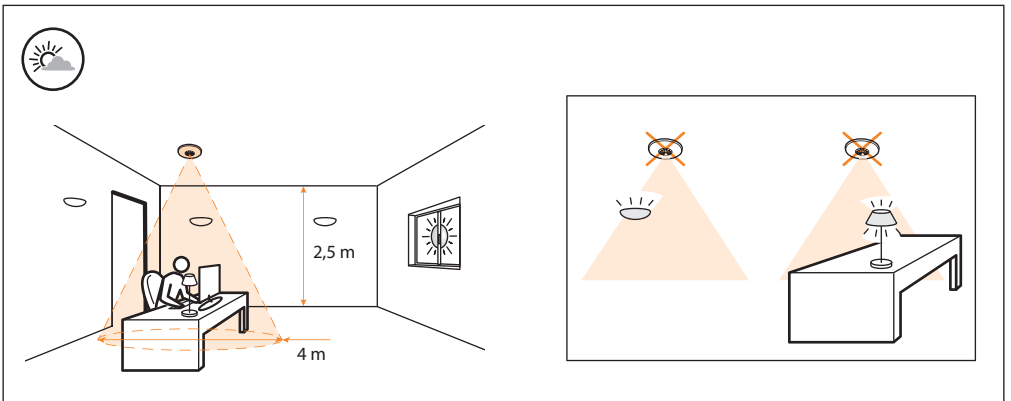
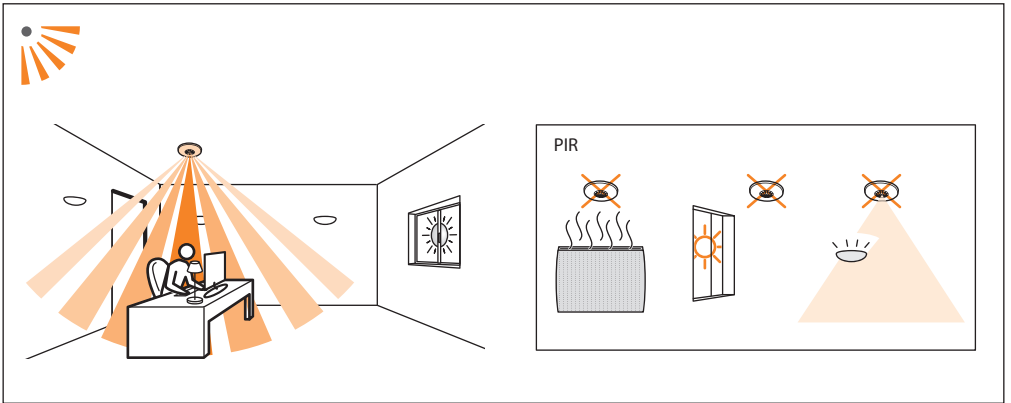
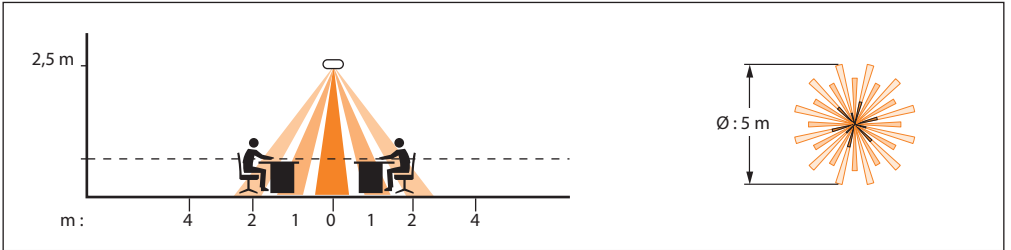
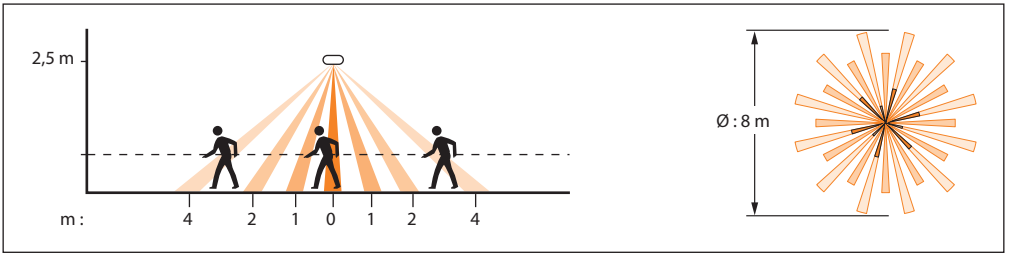

230
110 VAC

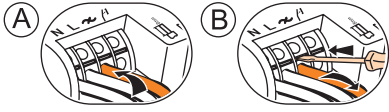



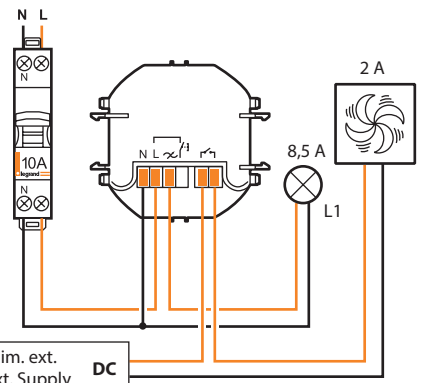
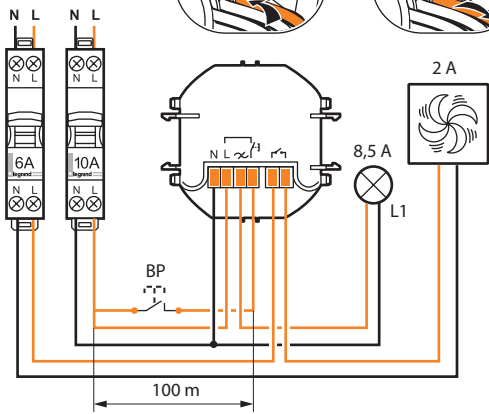

$U \leq 30V=$

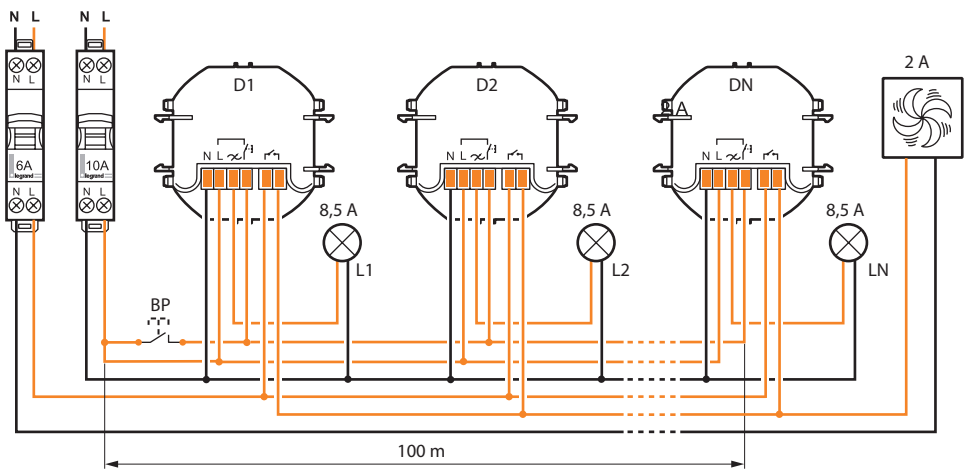



- Alim. ext.
 - Ext. Supply
 - Alimentazione esterna
- DC

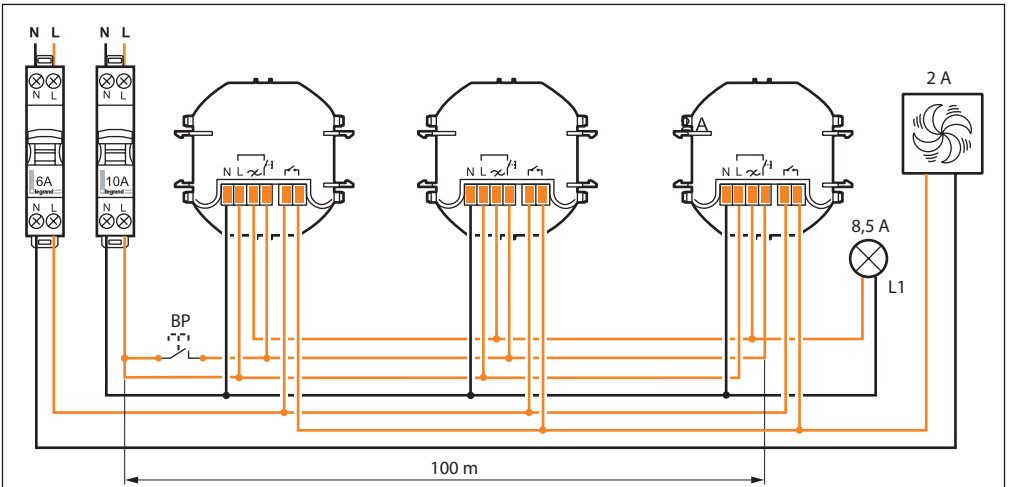

- Inversion de l'état des charges :  < 1 s
- Reversal of load status :
- Inversione dello stato dei carichi
- Synchronisation de toutes les charges à ON :  > 1 s
- Switching all loads to ON :
- Accensione di tutti i carichi
- Synchronisation de toutes les charges à OFF :  > 1 s +  < 1 s
- Switching all loads to OFF :
- Spegnimento di tutti i carichi



- Etat des charges ON :  > 1 s
- Load status ON :
- Stato del carico ON

- Etat des charges OFF :  > 1 s +  < 1 s
- Load status OFF :
- Stato del carico OFF

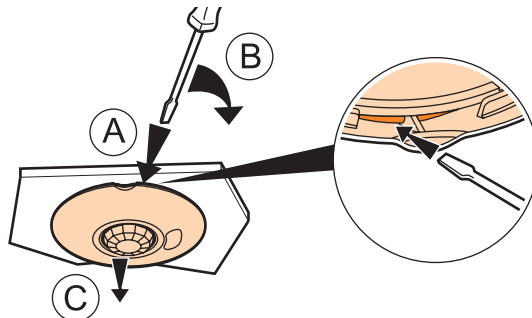
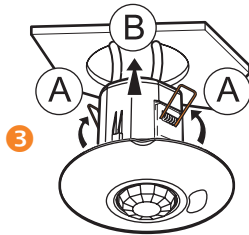
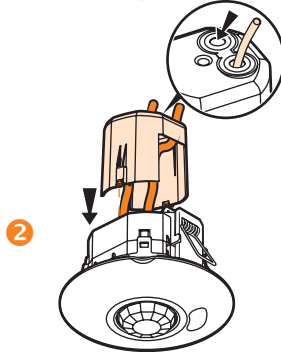
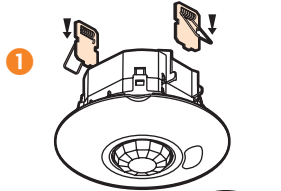

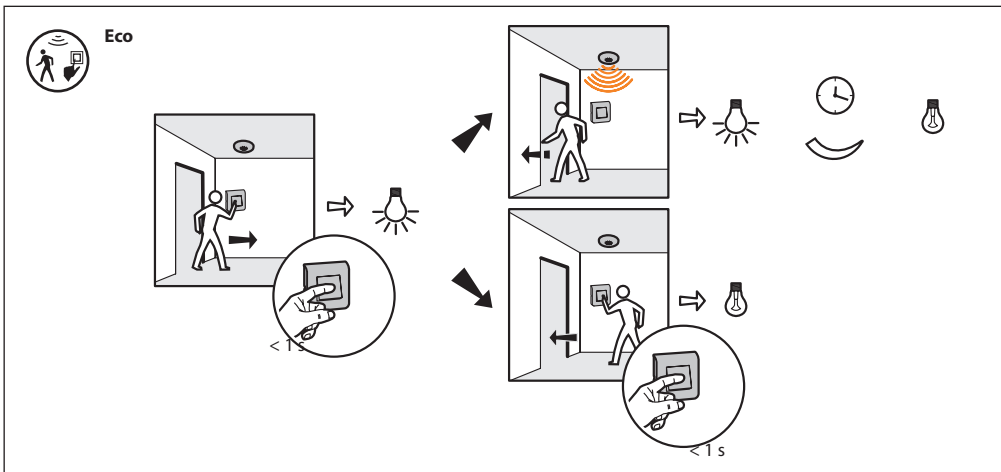
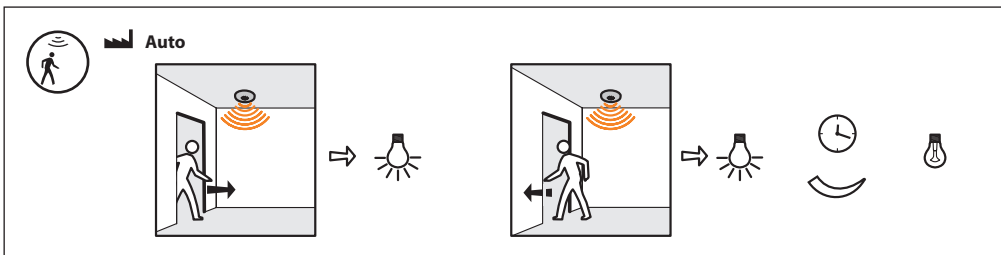

Al primo utilizzo: Scaricare l'app Legrand Close Up su Apple Store o Play Store.

Ref. 0 882 40: Gateway di configurazione

App Store Google Play

App: «Legrand Close Up»

Per maggiori informazioni sulle impostazioni, consultare la scheda tecnica del gateway di configurazione Ref. 0 882 40.

	5 - 1275 lux
	5 sec - 59 min 59 sec
	25% - 50% - 75% - 100%
Mode	Auto - Eco - Walkthrough

The diagram shows the top view of the sensor unit. It is a circular device with a central lens. There are two orange dots labeled 'LED IR' and two orange dots labeled 'LED LEARN'.