











- | | | | | | | | | | |
|-----------|---|-----------|---|-----|--|-----------|---|-----|---|
| 4 x
M6 |  | 4 x
M6 |  | 4 x |  | 4 x
M8 |  | 4 x |  |
|-----------|---|-----------|---|-----|--|-----------|---|-----|---|

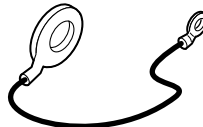
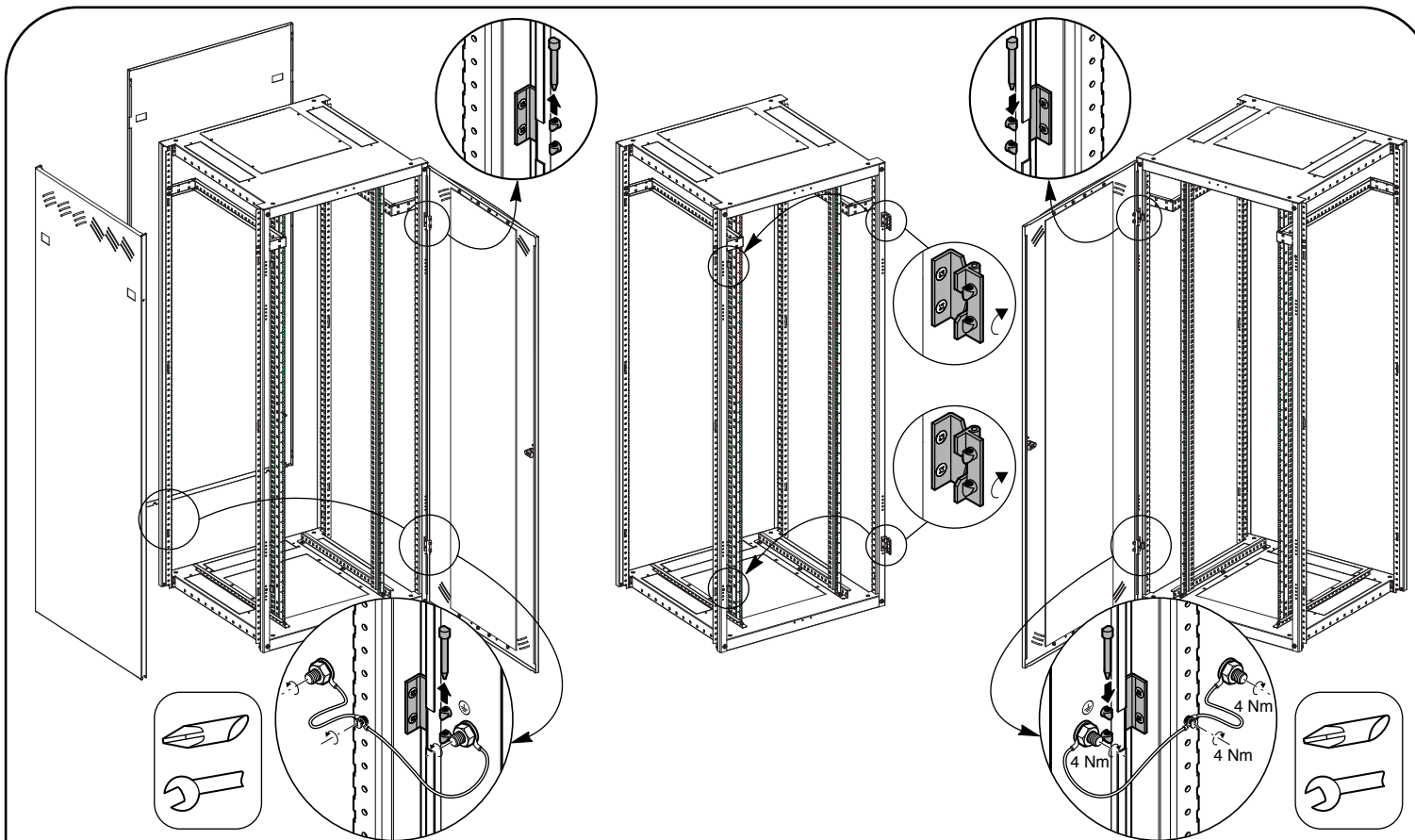

- | | | | | | | | | | |
|-----------|---|-----------|---|-----|---|-----------|---|-----|---|
| 4 x
M6 |  | 4 x
M6 |  | 4 x |  | 4 x
M8 |  | 4 x |  |
|-----------|---|-----------|---|-----|---|-----------|---|-----|---|

ENNA01580 TA