

Liquid Level Sensor That Is Unaffected by the Color of the Pipe or Liquid

- Mount to bypass pipes.
- Fit a wide range of pipe diameters: 8 to 11 mm or 12 to 26 mm
- Built-in Amplifiers to save space.





For the most recent information on models that have been certified for safety standards, refer to your OMRON website.



Be sure to read *Safety Precautions* on page 3.

Ordering Information

Sensors [Refer to *Dimensions* on page 5.]

Sensing method	Applicable pipe diameters	Appearance	Output configuration/Operation mode	Model	
Capacitive	8 to 11 mm		NPN open-collector output	NO	E2K-L13MC1 2M
				NC	E2K-L13MC2 2M
	12 to 26 mm			NO	E2K-L26MC1 2M
				NC	E2K-L26MC2 2M

Ratings and Specifications

Item	Model	E2K-L13MC□	E2K-L26MC□	
Applicable pipes	Materials	Non-metal		
	Size	Diameter	8 to 11 mm	12 to 26 mm
		Thickness	1 mm max.	1.5 mm max.
Detectable object		Liquid *		
Repeat accuracy		±0.2 mm max.		
Differential travel (Reference value, varies with pipe size and liquid.)		0.6 to 5 mm	0.3 to 3 mm	
Power supply voltage (operating voltage range)		12 to 24 VDC (10.8 to 30 VDC), ripple (p-p): 10% max.		
Current consumption		12 mA max.		
Control output	Load current	100 mA max.		
	Residual voltage	1 V max. (Load current: 100 mA, Cable length: 2 m)		
Sensing liquid position		Indented mark position (For details, refer to <i>Technical Guide (Operational version)</i> .)		
Indicators		Detection indicator (orange)		
Ambient temperature range		Operating: 0 to 55°C (with no icing or condensation), Storage: -10 to 65°C (with no icing or condensation)		
Ambient humidity range		Operating/Storage: 25% to 85% (with no condensation)		
Temperature influence		±4 mm of detection level at 23°C in the temperature range of 0 to 55°C (with pure water or 20% saline solution) (±6 mm for E2K-L13MC□ with pure water and a pipe diameter of 8 mm)		
Voltage influence		±0.5 mm of detection level at the rated voltage in rated voltage ±10% range		
Insulation resistance		50 MΩ min. (at 500 VDC) between current-carrying parts and case		
Dielectric strength		500 VAC, 50/60 Hz for 1 min between current-carrying parts and case		
Vibration resistance		Destruction: 10 to 55 Hz, 1.5-mm double amplitude for 2 hours each in X, Y, and Z directions		
Shock resistance		Destruction: 500 m/s ² 3 times each in X, Y, and Z directions		
Degree of protection		IP66 (IEC)		
Connection method		Pre-wired Models (Standard cable length: 2 m)		
Weight (packed state)		Approx. 70 g		
Materials	Case, Cover	Heat-resistant ABS		
	Cable clamp	NBR		
Accessories		Two bands, Four slip-proof tubes, One driver for sensitivity adjustment, Instruction manual		

* Stable detection will not be possible in the following cases. Confirm detection capability with the Sensor installed before actual application.

1. If the specific inductive capacity or the specific electric conductivity of the liquid is too low, the liquid position may not be detected since this sensor is a capacitive sensor.
2. If the quantity of liquid is too low or the change in quantity is too low in comparison to the change in liquid level because the pipe is too thin or the walls of the pipe are too thick
3. If there is a viscous film on the inner pipe wall, large quantities of foam or air bubbles, or excessive buildup of dirt on the inner pipe wall

Engineering Data (Reference Value)

Influence of Temperature and Sensing Liquid Level

E2K-L13MC□

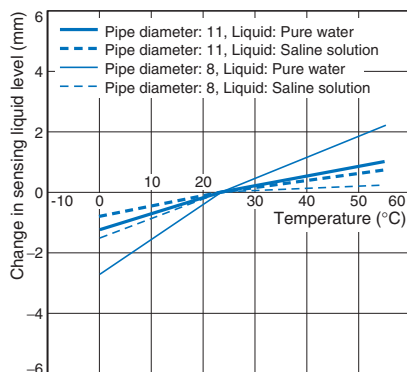

E2K-L26MC□

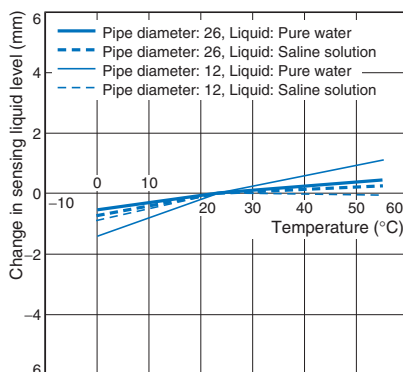

I/O Circuit Diagrams

Operation mode	Model	Timing chart	Output circuit
NO	E2K-L13MC1 E2K-L26MC1	<p>Liquid level Present </p> <p>Load (between brown and black leads) Operate </p>	
NC	E2K-L13MC2 E2K-L26MC2	<p>Liquid level Present </p> <p>Load (between brown and black leads) Operate </p>	

Safety Precautions

Refer to *Warranty and Limitations of Liability*.

⚠ WARNING

This product is not designed or rated for ensuring safety of persons either directly or indirectly. Do not use it for such purposes.



Precautions for Correct Use

Do not use this product under ambient conditions that exceed the ratings.

● Design

Influence of Surrounding Objects

When mounting the Sensor, maintain at least the distances in the following diagrams from surrounding metal objects or other conductors to prevent the Sensor from being affected by objects other than the sensing object.

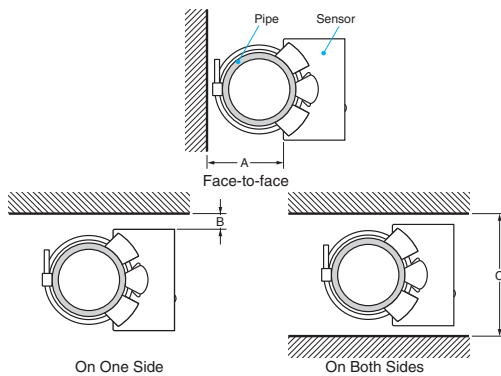

Influence of Surrounding Objects

(Unit: mm)

Model	Distance	A	B	C
E2K-L13MC□	25	25	5	45
E2K-L26MC□			0	40

Mutual Interference

When installing Sensors in series, in parallel, or face-to-face, ensure that the minimum distances given in the following table are maintained.

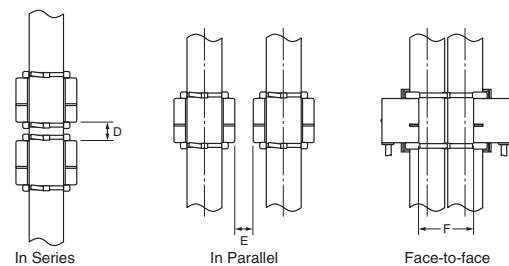

Mutual Interference

(Unit: mm)

Model	Distance	D *	E	F
E2K-L13MC□	10	10	10	25
E2K-L26MC□				30

* Also, always adjust the bottom Sensor first because adjusting the bottom Sensor may affect the detection level of the top Sensor.

● Mounting

Mounting

Mount the Sensor securely to the pipe using the enclosed two bands and four slip-proof tubes (two tubes used for each band) as shown in the following diagram.

When mounting the Sensor, be sure the entire Sensor is tight against the pipe along the sensing surface.

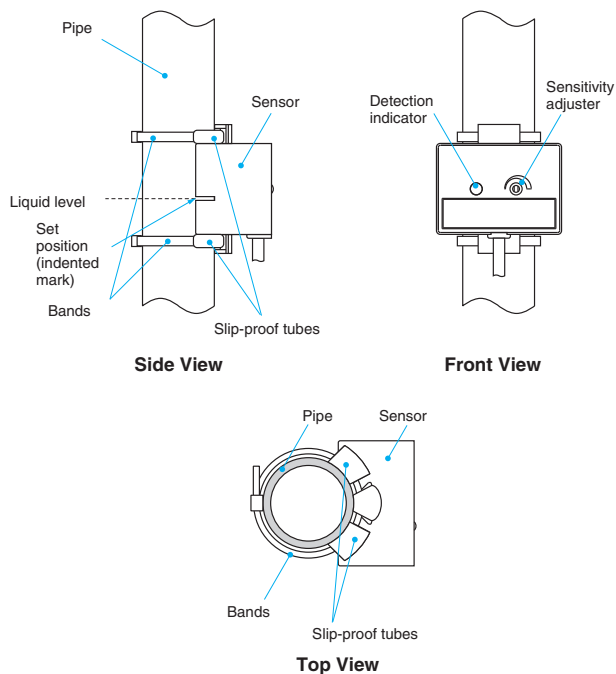

Sensitivity Adjustment

For information on the sensitivity adjustment, refer to *Technical Guide for Operation* for information for Proximity Sensor.

● Wiring

Power Supply

- If the load and Sensor are connected to different power supplies, always turn ON the Sensor power first.
- Switching noise can cause operating mistakes if a commercial switching regulator is used. When using a switching regulator, always ground the frame ground terminal and the ground terminal.

● Operating Environment

Ambient Atmosphere

- Although the Sensor is water resistance, it is a capacitive sensor and should not be used where it will come into direct contact with liquids, such as water or cutting oil.
- The life of the Sensor will be shortened by rapid changes in temperature even within the ambient operating temperature range. Do not use the Sensor in locations subject to rapid temperature changes.

● Miscellaneous

Drift will occur when the power supply is turned ON. If the specific inductive capacity of the sensing liquid is low, the detection level may increase by 2 to 3 mm during the 20 minutes required from the time the power supply is turned ON until operation stabilizes.

Terms and Conditions Agreement

Read and understand this catalog.

Please read and understand this catalog before purchasing the products. Please consult your OMRON representative if you have any questions or comments.

Warranties.

(a) Exclusive Warranty. Omron's exclusive warranty is that the Products will be free from defects in materials and workmanship for a period of twelve months from the date of sale by Omron (or such other period expressed in writing by Omron). Omron disclaims all other warranties, express or implied.

(b) Limitations. OMRON MAKES NO WARRANTY OR REPRESENTATION, EXPRESS OR IMPLIED, ABOUT NON-INFRINGEMENT, MERCHANTABILITY OR FITNESS FOR A PARTICULAR PURPOSE OF THE PRODUCTS. BUYER ACKNOWLEDGES THAT IT ALONE HAS DETERMINED THAT THE PRODUCTS WILL SUITABLY MEET THE REQUIREMENTS OF THEIR INTENDED USE.

Omron further disclaims all warranties and responsibility of any type for claims or expenses based on infringement by the Products or otherwise of any intellectual property right. (c) Buyer Remedy. Omron's sole obligation hereunder shall be, at Omron's election, to (i) replace (in the form originally shipped with Buyer responsible for labor charges for removal or replacement thereof) the non-complying Product, (ii) repair the non-complying Product, or (iii) repay or credit Buyer an amount equal to the purchase price of the non-complying Product; provided that in no event shall Omron be responsible for warranty, repair, indemnity or any other claims or expenses regarding the Products unless Omron's analysis confirms that the Products were properly handled, stored, installed and maintained and not subject to contamination, abuse, misuse or inappropriate modification. Return of any Products by Buyer must be approved in writing by Omron before shipment. Omron Companies shall not be liable for the suitability or unsuitability or the results from the use of Products in combination with any electrical or electronic components, circuits, system assemblies or any other materials or substances or environments. Any advice, recommendations or information given orally or in writing, are not to be construed as an amendment or addition to the above warranty.

See <http://www.omron.com/global/> or contact your Omron representative for published information.

Limitation on Liability: Etc.

OMRON COMPANIES SHALL NOT BE LIABLE FOR SPECIAL, INDIRECT, INCIDENTAL, OR CONSEQUENTIAL DAMAGES, LOSS OF PROFITS OR PRODUCTION OR COMMERCIAL LOSS IN ANY WAY CONNECTED WITH THE PRODUCTS, WHETHER SUCH CLAIM IS BASED IN CONTRACT, WARRANTY, NEGLIGENCE OR STRICT LIABILITY.

Further, in no event shall liability of Omron Companies exceed the individual price of the Product on which liability is asserted.

Suitability of Use.

Omron Companies shall not be responsible for conformity with any standards, codes or regulations which apply to the combination of the Product in the Buyer's application or use of the Product. At Buyer's request, Omron will provide applicable third party certification documents identifying ratings and limitations of use which apply to the Product. This information by itself is not sufficient for a complete determination of the suitability of the Product in combination with the end product, machine, system, or other application or use. Buyer shall be solely responsible for determining appropriateness of the particular Product with respect to Buyer's application, product or system. Buyer shall take application responsibility in all cases.

NEVER USE THE PRODUCT FOR AN APPLICATION INVOLVING SERIOUS RISK TO LIFE OR PROPERTY OR IN LARGE QUANTITIES WITHOUT ENSURING THAT THE SYSTEM AS A WHOLE HAS BEEN DESIGNED TO ADDRESS THE RISKS, AND THAT THE OMRON PRODUCT(S) IS PROPERLY RATED AND INSTALLED FOR THE INTENDED USE WITHIN THE OVERALL EQUIPMENT OR SYSTEM.

Programmable Products.

Omron Companies shall not be responsible for the user's programming of a programmable Product, or any consequence thereof.

Performance Data.

Data presented in Omron Company websites, catalogs and other materials is provided as a guide for the user in determining suitability and does not constitute a warranty. It may represent the result of Omron's test conditions, and the user must correlate it to actual application requirements. Actual performance is subject to the Omron's Warranty and Limitations of Liability.

Change in Specifications.

Product specifications and accessories may be changed at any time based on improvements and other reasons. It is our practice to change part numbers when published ratings or features are changed, or when significant construction changes are made. However, some specifications of the Product may be changed without any notice. When in doubt, special part numbers may be assigned to fix or establish key specifications for your application. Please consult with your Omron's representative at any time to confirm actual specifications of purchased Product.

Errors and Omissions.

Information presented by Omron Companies has been checked and is believed to be accurate; however, no responsibility is assumed for clerical, typographical or proofreading errors or omissions.