

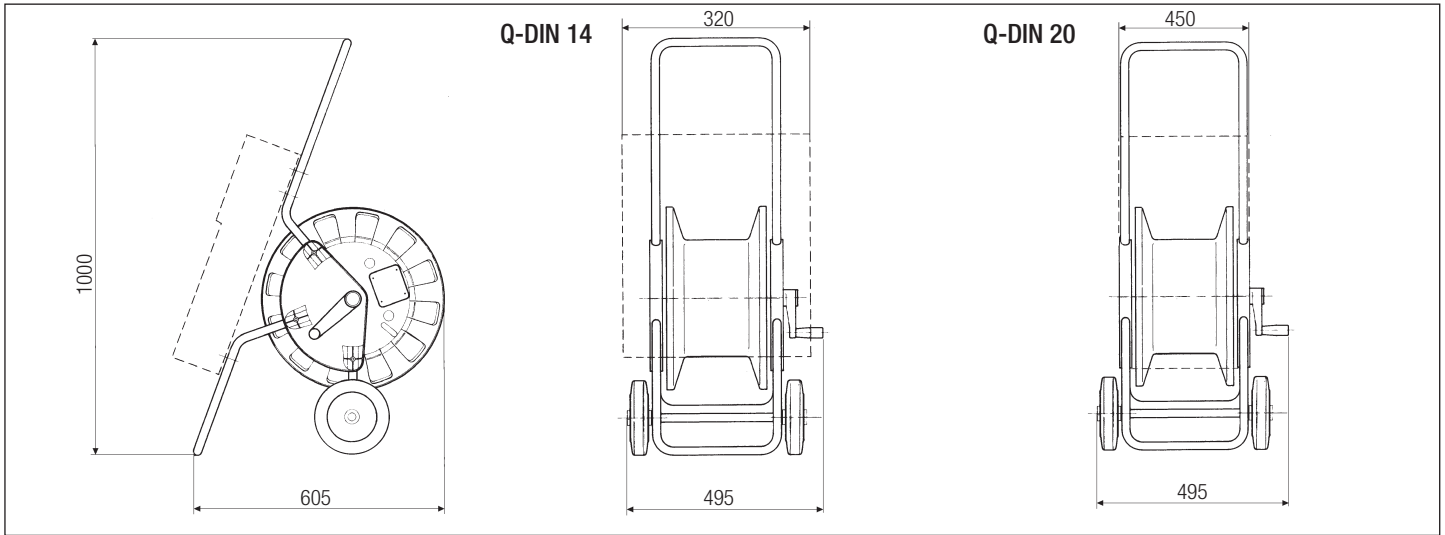

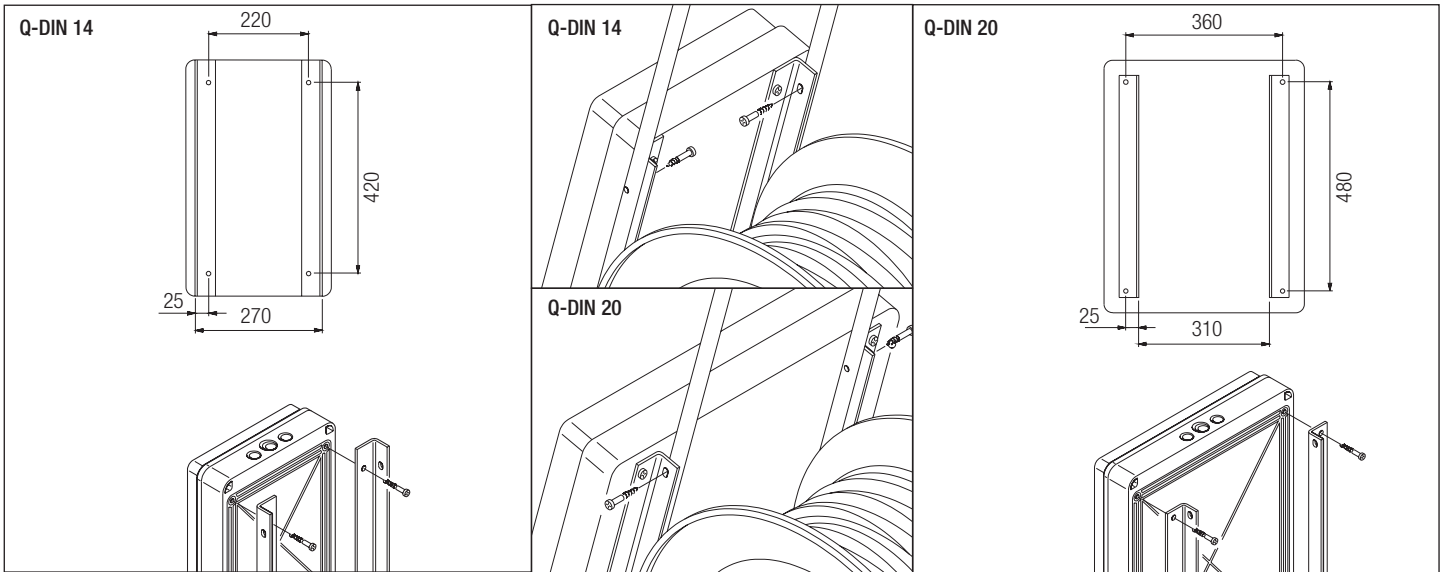













cod. 7.55.4.075.7



	H07RN-F	m		
GW 68411 N	H07RN-F 5x 2,5 mm <sup>2</sup>	25	2P+  <b>MAX 2kW</b>	2P+  <b>MAX 3,5kW</b>
			3P+  <b>MAX 6kW</b>	3P+  <b>MAX 9,5kW</b>
GW 68421 N	H07RN-F 5x4 mm <sup>2</sup>	35	2P+  <b>MAX 2kW</b>	2P+  <b>MAX 6,3kW</b>
			3P+  <b>MAX 6kW</b>	3P+  <b>MAX 19kW</b>
GW 68424 N	H07RN-F 5x4 mm <sup>2</sup>	25	2P+  <b>MAX 2kW</b>	2P+  <b>MAX 6,3kW</b>
			3P+  <b>MAX 6kW</b>	3P+  <b>MAX 19kW</b>

Ai sensi delle Decisioni e delle Direttive Europee applicabili, si informa che il responsabile dell'immissione del prodotto sul mercato Comunitario è:

According to the applicable Decisions and European Directives, the responsible for placing the apparatus on the Community market is:

**GEWISS S.p.A.** Via A.Volta, 1 IT-24069 Cenate Sotto (BG) Italy Tel: +39 035 946 111 Fax: +39 035 946 270 E-mail: [qualitymarks@gewiss.com](mailto:qualitymarks@gewiss.com)



**+39 035 946 111**  
8.30 - 12.30 / 14.00 - 18.00  
lunedì - venerdì - monday - friday



**+39 035 946 260**



**sat@gewiss.com**  
**www.gewiss.com**

ULTIMA REVISIONE 09/2015