

Esmi Impresia Potential Output for Sounder Module

Instruction Sheet
R10209GB0



Schneider Electric Fire & Security Oy

Sokerilinnantie 11 C
FI-02600 Espoo, Finland
Tel: +358 10 446 511
Website: www.se.com
Document number: R10209GB0
Published: 18.12.2020

© 2020 – Schneider Electric. All Rights Reserved. This information is only to be used as guidance. Subject to changes and errors.

1 Esmi Impresia Potential Output for Sounder

Esmi Impresia Potential Output for Sounder Module (FFS06741019) is an addressable module with one potential designed for installing in addressable fire alarm systems with Esmi ELC loop controller supporting Schneider Electric communication protocol.

The module provides interface between a zone of conventional sounders and FDP fire panels. It has a built-in isolator module which when used allows continuous operation of the loop in case of module's failure and without need of using additional isolator modules.

In case of fault condition the module will not activate its output circuit. If the output circuit is ON and a fault condition appears, it will be switched automatically OFF. When the fault condition disappear the output circuit will restore to its last condition (ON/OFF), if the condition was not changed until that moment. The module is mounted in a separate plastic box suitable for wall mounting and with IP55 protection. EN54-18 for indoor and outdoor use.

The module monitors and transfers to control panel the status of the output - short circuit, interruption or missing of power supply in the circuit.



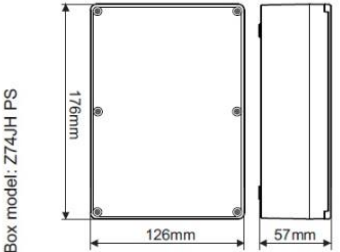

 DoP No: DP20035
 Made in Bulgaria
 EN 54-18:2005
 EN 54-18:2005/AC:2007
 EN 54-17:2005
 EN 54-17:2005/AC:2007

! Dimensions



Box model: Z74.JH PS

! Installation

-  IP55
-  -10°C ÷ +60°C
-  ~320g
-  2.5mm²



 Indoor use



 Outdoor use

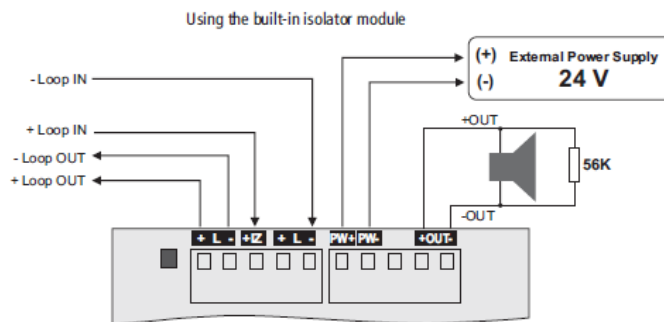
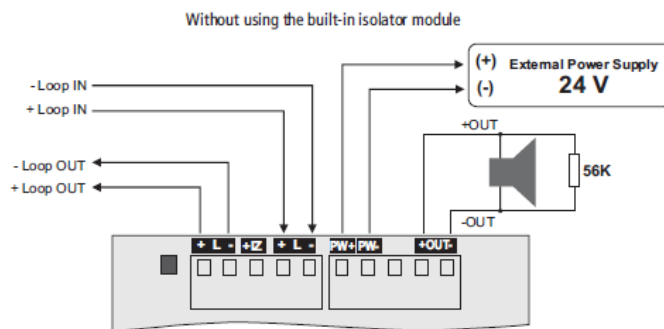

1.1.1 LED Indication

In normal operation mode the **red LED** blinks at every communication between the module and the fire panel.

The **red LED** lights on permanently when the output is activated*.

**Note: LED indication follows the logical state of the module.*

The **yellow LED** lights on permanently in case of the following conditions in the output line: Short circuit in the

line; Open line; External power supply fault.

The LED activation can be disabled from panel's menu - IRIS/SIMPO.

1.1.2 Description of the connection diagram

-L (-Loop IN) - Connect the negative wire of the input communication line.

+L (+Loop IN) - Connect the positive wire of the input communication line.

-L (-Loop OUT) - Connect the negative wire of the output communication line.

+L (+Loop OUT) - Connect the positive wire of the output communication line.

PW+ (Power +) - Connect the "+" wire of the external power supply of the output.

PW- (Power -) - Connect the "-" wire of the external power supply of the output.

+OUT - Connect the positive wire of the output.

-OUT - Connect the negative wire of the output.

ATTENTION: When you use the integrated short circuit isolation module connect one of the "+Loop" loop lead to the "+IZ" terminal of the module!

1.2 Installation

Attention: Turn power off the loop circuit before installing the module!

1. Choose the proper place for installation of the device.
2. Set the module address using programmer or directly from addressable fire panel.
3. Run the wires to the module terminals.
4. Connect the wires of the external power supply to the terminals PW+ and PW- of the module as shown on the connection diagram.
5. Connect the wires of the output to terminals OUT+ and OUT- of the module as shown on the connection diagram.
6. Connect the wires of the communication line - with or without using the built-in isolator.
7. Test the module for proper operation and LED indication.
8. Close the cover of the plastic box.

