

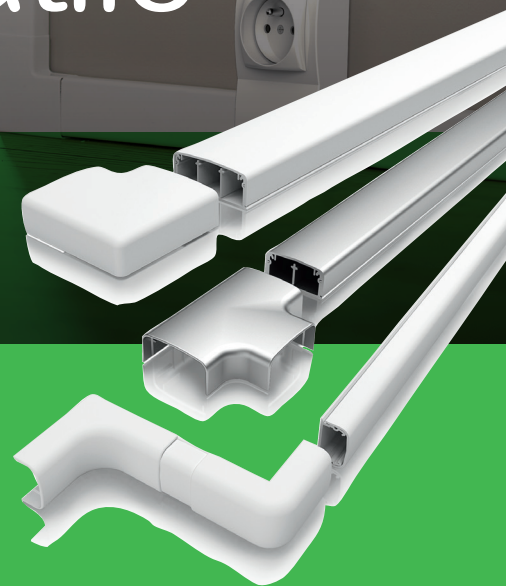

# Safe and smoothly shaped for versatile use

Catalogue 2020

OptiLine Mini-trunking



[se.com](https://se.com)

Life Is On

**Schneider**  
Electric



---

Presentation .....	5
Range .....	10
Technical description .....	17
Reference list.....	19
Note .....	20



- Fast to install
- Robust and versatile
- Stylish and safe
- IP40
- Tamper-proof
- Impact-resistant
- PVC, halogen-free PC/ABS or aluminium

# OptiLine Mini-trunking

## Building bricks for a customised cabling solution

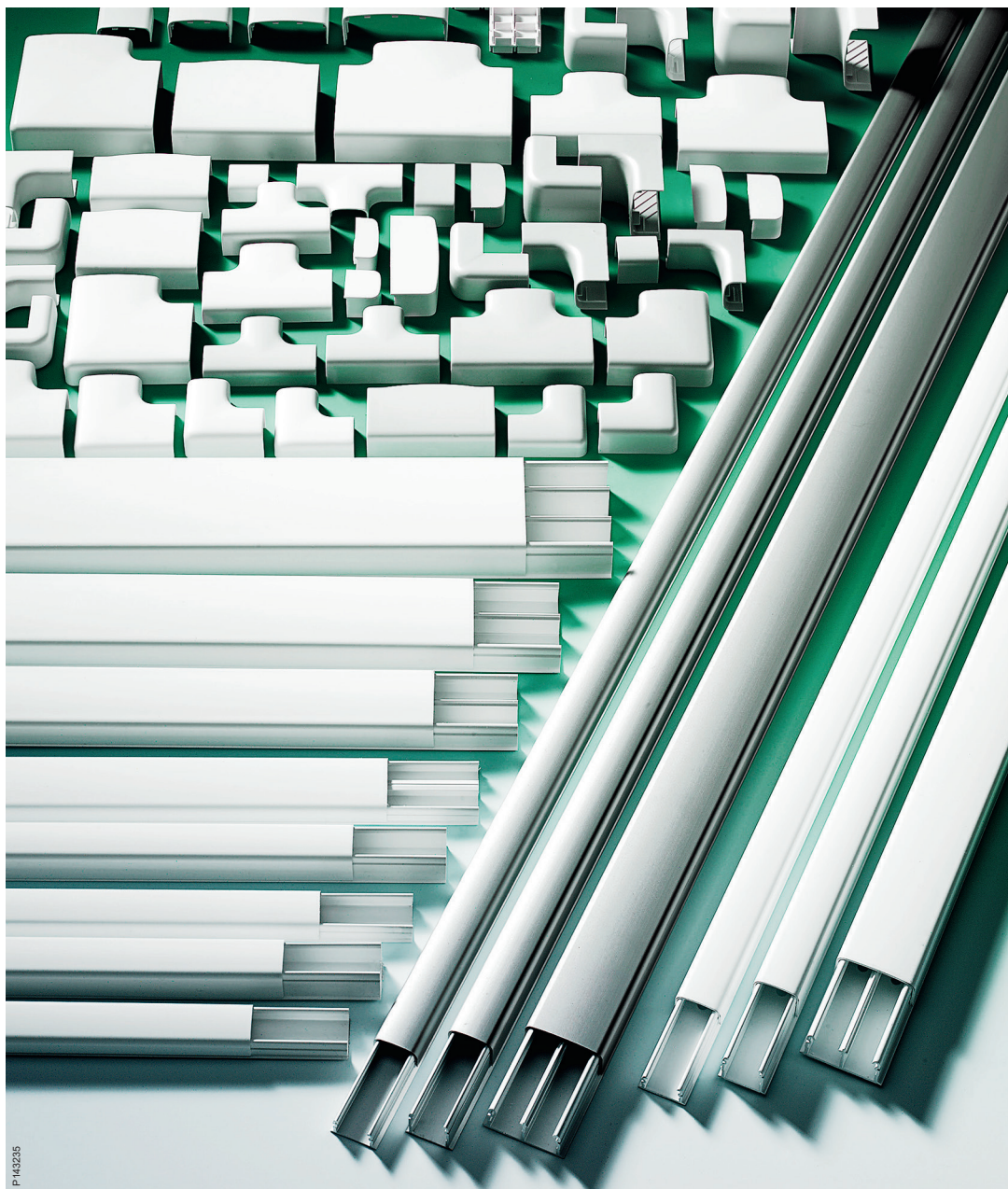

With a wide range of sizes and accessories, together with elegant design in various materials, OptiLine Mini-trunking offers great opportunities to create innovative, aesthetical installations. And since the cover cannot be removed without tools, OptiLine Mini-trunking is also safe and resistant to external damage. All together, a nice-looking solution suitable at home as well as in all kinds of public and commercial buildings.



## Mini-trunking with both looks and brains

The OptiLine Mini-trunking system is the result of our aim to develop an attractive, functional trunking for small installations in all kinds of environments. The smooth design in white PVC, halogen-free plastic or aluminium makes OptiLine not only nice to look at; it is also robust, versatile and durable. Together with the wide variety of sizes and accessories, OptiLine mini-trunking is the perfect choice for elegant and safe installations, even in more exposed environments.



PE1837

### Environment-friendly

OptiLine Mini-trunking is available in three materials; aluminium, lead and cadmium-free PVC or halogen-free plastic (PC/ABS). Accessories, like corners and end pieces, are made of halogen-free plastic (PC/ABS).



PE1849

### Highly impact-resistant

All mini-trunking is highly impact-resistant, thanks to its design and generous material thickness. The aluminium version of OptiLine offers extra strong impact-resistance. In many cases, this is an ideal substitute for unattractive sheet steel protection.

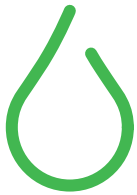

The superb finish makes OptiLine Mini-trunking resistant to humidity while providing a hygienic surface that is very easy to keep clean.



PE5169

### Both outdoors and indoors

Thanks to its sealed, stable design, OptiLine Mini-trunking achieves the degree of protection IP40, making it suitable for installations both outdoors and indoors. The plastic as well as the aluminium trunking offer many years of resistance to UV radiation, heat and cold. The plastic trunking is also approved for single-insulated wire outdoors.



PE5042

### A solution to every situation

All in all, the OptiLine Mini-trunking range includes all accessories and modules needed to create a customised solution, even when using various dimensions.

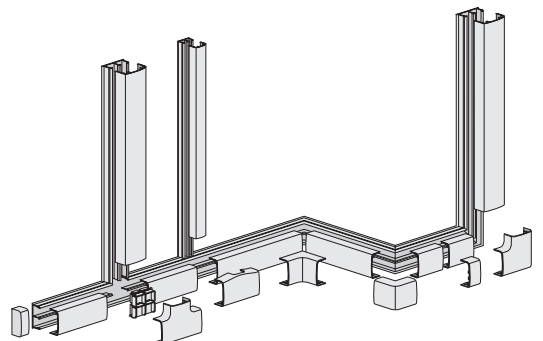

PE5025

## 12 strong reasons to choose OptiLine Mini-trunking

### 1. Freedom of choice

The most comprehensive system on the market with a wide range of trunking dimensions and accessories.

### 2. An integrated system

OptiLine mini-trunking of different types can be joined together.

### 3. "Safety trunking"

Can only be opened with tools.

### 4. Soft design

The smoothly rounded cover surrounds the trunking base and has no joints.

### 5. Easy to clean

High surface finish and hidden joints.

### 6. Quality through and through

High-grade, UV-resistant materials.

### 7. Easy to handle

Both profiles are U-shaped.

### 8. Impact-resistant

The aluminium trunking is extra tamper-proof.

### 9. Cut on free hand

Accessories and joint cover pieces conceal uneven cuts.

### 10. Easy to install

Pre-punched screw holes or adhesive and built-in build tolerance on corners  $\pm 5^\circ$  or  $\pm 10$  for adjustable corners.

### 11. High degree of protection

IP40 and classified for single-insulated wire.

### 12. Fireproof

Aluminium or self-extinguishing PVC.



# Safe and smooth design – and a joy to work with

One of the most satisfying things with our job, is when we succeed in making a successful product even better. The OptiLine mini-trunking range now includes even more versions: a new dimension of the polar white two-compartment mini-trunking and a PVC-trunking in three sizes with an ingenious integrated cable retaining function.



### Tamper-proof

The trunking and all its accessories use snap fitting for quick, simple installation. Removing the cover and accessories without the right tools is far more difficult; a design feature that protects the installation from tampering, especially recommended in public areas or for fibre optic and broadband cables.



### Branching piece

Create a combined trunking installation by running the feed in two- or three-compartment PVC trunking. Then just connect, for example, aluminium trunking where extra impact resistance or a more exclusive impression is needed. The practical branching piece makes changes of dimensions simple.

P143237



### Fly-over

For installations in two- and three-compartment trunking, use the fly-over to separate power and data cables where they cross each other. The fly-over can be quickly adjusted in function by easily breaking off the partition walls.

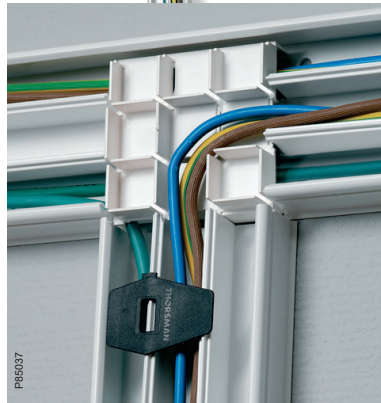

### Cable clamp

To keep the cables in place during the installation phase, cable holders are available as accessories. They are easy to snap-fit and can remain in place when the cover is fitted.

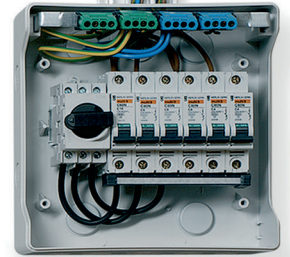
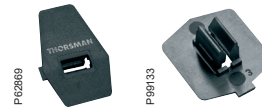

### Single-insulated wire

For single-insulated wires to be installed in mini-trunking, the trunking must comply with stringent regulations regarding electrical safety. The plastic versions of OptiLine Mini-trunking meets these requirements if installed with insulated screw TFT-IS (4020210).

### Easy to cut

The trunking and the partition walls can be cut by hand with simple tools – no need for precision. The accessories are very forgiving.

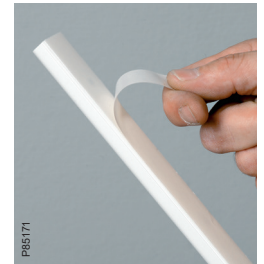
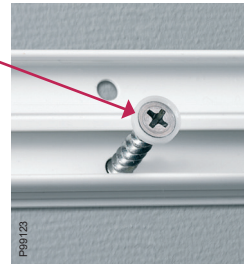
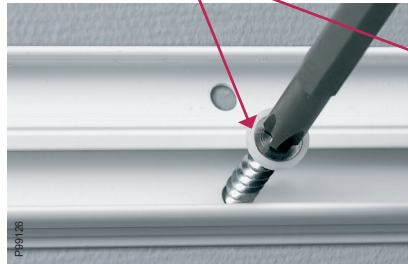

### Screws or adhesive tape

OptiLine Mini-trunking has pre-punched holes at frequent intervals to make installation easier. For low voltage installations, there are also some OptiLine Mini-trunking sizes with adhesive tape fixing. On suitable surfaces, this method is unsurpassed when it comes to making speedy installations. If you install power cables in the OptiLine Mini-trunking, you must use screws, nails, or nail plug fixings. If you install single insulated power cables, you must use insulated screw TFT-IS (4020210).

### Integrated cable retainer

To simplify installation even more, the range includes three trunking sizes equipped with an integrated cable retaining function. The flexible "wings" prevent cables from falling out during installation.

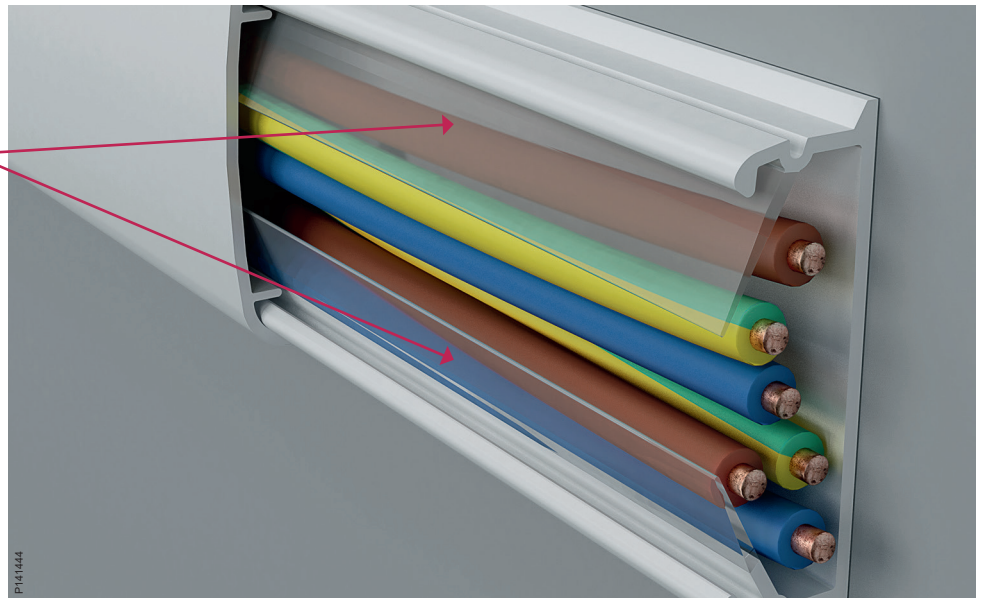

### Cable separation



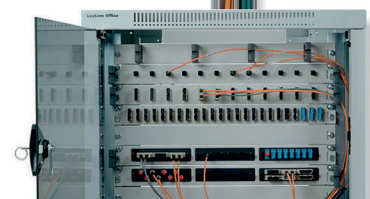







Mixed installations in which power and data wiring is run to the same point are becoming increasingly common. This is why OptiLine mini-trunking is available with several compartments, so that the entire installation can be accommodated in one trunking.













Mini-trunking

	Type	Colour	Dimensions A/B/C (mm)		Qty per package	EAN code	Ref. No.
<b>PVC mini-trunking</b>							
Mini-trunking including base profile with one, two or three compartments, and snap-fitted cover. Partition walls can be removed. With pre-punched mounting holes at 100 mm centres. Suitable for power and low voltage cables. Approved for single-insulated cable if non-metallic fastener is used. Supplied in 2.1 m lengths. Material: PVC.							
P83321	With one compartment	Polar white White Black	20/12/2100		42 m	3606480682933 3606480310737 3606481500045	ISM14100P ISM14100 ISM14140
P83323	With two compartments	Polar white White Black	30/12/2100		42 m	3606480682971 3606480310911 3606481500052	ISM14200P ISM14200 ISM14240
P141435	With two compartments	Polar white	35/15/2100		42 m	3606480694097	ISM14700P
P83322	With one compartment	Polar white White Black	20/18/2100		42 m	3606480682988 3606480310980 3606481500069	ISM14300P ISM14300 ISM14340
P83324	With two compartments	Polar white White Black	35/18/2100		42 m	3606480683022 3606480311161 3606481500076	ISM14400P ISM14400 ISM14440
P83325	With two compartments	Polar white White Black	45/18/2100		42 m	3606480683046 3606480311352 3606481500083	ISM14500P ISM14500 ISM14540
P83326	With three compartments	Polar white White Black	60/25/2100		21 m	3606480683053 3606480311437 3606481500090	ISM14600P ISM14600 ISM14640
<b>PVC mini-trunking with integrated cable retaining function</b>							
Mini-trunking including base profile with one compartment and snap-fitted cover. The base profile has an integrated cable retaining function, flexible at the cable entry, preventing cables from falling out of the base profile during installation. With pre-punched mounting holes at 100 mm centres. Suitable for power and low voltage cables. Approved for single-insulated cable if non-metallic fastener is used. Supplied in 2.1 m lengths. Material: PVC.							
P141434	With one compartment	Polar white	30/12/2100		42 m	3606480694172	ISM14230P
P141436	With one compartment	Polar white	35/15/2100		42 m	3606480694165	ISM14730P
P141437	With one compartment	Polar white	45/18/2100		42 m	3606480694080	ISM14530P
<b>PVC mini-trunking with bonding tape</b>							
Mini-trunking including base profile with one compartment and snap-fitted cover. With pre-punched mounting holes at 100 mm centres. Provided with bonding tape on the back of the base profile. Not approved for power cabling if the trunking is only fixed to the wall by the tape. If the fixing by tape is combined with screw-fixing, power cables may also be installed. Approved for single-insulated cable if non-metallic fastener is used for the combined fixing. Supplied in 2.1 m lengths. Material: PVC.							
P83321	With one compartment	Polar white White Black	20/12/2100		42 m	3606480682940 3606480310805 3606489604080	ISM14125P ISM14125 ISM14145
B83322	With one compartment	Polar white White Black	20/18/2100		42 m	3606480682995 3606480311055 3606489604097	ISM14325P ISM14325 ISM14345
P83323	With two compartments	Polar white	30/12/2100		42 m	3606489604103	ISM14225P

Mini-trunking

Type	Colour	Dimensions A/B/C (mm)	Qty per package	EAN code	Ref. No.
<b>PVC min-trunking with bonding tape and integrated cable retaining function</b>					
Mini-trunking including base profile with one compartment and snap-fitted cover. The base profile has an integrated cable retaining function, flexible at the cable entry, preventing cables from falling out of the base profile during installation. With pre-punched mounting holes at 100 mm centres. Provided with bonding tape on the back of the base profile. Not approved for power cabling if the trunking is only fixed to the wall by the tape. If the fixing by tape is combined with screw-fixing, power cables may also be installed. Approved for single-insulated cable if non-metallic fastener is used for the combined fixing. Supplied in 2.1 m lengths. Material: PVC.					
P141434 	With one compartment	Polar white	30/12/2100	33.6 m	3606489604110 <b>ISM14235P</b>
<b>PC/ABS (halogen-free) mini-trunking</b>					
Mini-trunking including base profile with one, two or three compartments and snap-fitted cover. Partition walls can be removed. With pre-punched mounting holes at 100 mm centres. Suitable for power and low voltage cables. Approved for single-insulated cable if non-metallic fastener is used. Supplied in 2.1 m lengths. Material: PC/ABS.					
P83321 	With one compartment	Polar white White	20/12/2100	42 m	3606480682957 3606480310812 <b>ISM14130P</b> <b>ISM14130</b>
P83322 	With one compartment	Polar white White	20/18/2100	42 m	3606480683008 3606480311062 <b>ISM14330P</b> <b>ISM14330</b>
P83324 	With two compartments	Polar white White	35/18/2100	42 m	3606480683039 3606480311253 <b>ISM14430P</b> <b>ISM14430</b>
P83326 	With three compartments	Polar white White	60/25/2100	21 m	3606480683060 3606480311529 <b>ISM14630P</b> <b>ISM14630</b>
<b>PC/ABS (halogen-free) mini-trunking with bonding tape</b>					
Mini-trunking including base profile with one compartment and snap-fitted cover. Partition walls can be removed. With pre-punched mounting holes at 100 mm centres. Provided with bonding tape on the back of the base profile. Not approved for power cabling if the trunking is only fixed to the wall by the tape. If the fixing by tape is combined with screw-fixing, power cables may be installed. Approved for single-insulated cable if non-metallic fastener is used for the combined fixing. Supplied in 2.1 m lengths. Material: PC/ABS.					
P83321 	With one compartment	Polar white White	20/12/2100	42 m	3606480682964 3606480310829 <b>ISM14135P</b> <b>ISM14135</b>
P83322 	With one compartment	Polar white White	20/18/2100	42 m	3606480683015 3606480311079 <b>ISM14335P</b> <b>ISM14335</b>
<b>Aluminium mini-trunking</b>					
Mini-trunking including base profile with one or two compartments and snap-fitted cover. With pre-punched mounting holes at 400 mm centres. Suitable for power and low voltage cables. Supplied in 2.1 m lengths (please note that the base unit for aluminium mini-trunking is pcs). Material: Aluminium, natural anodized or powder coated white.					
P83318 	With one compartment	Anodized Polar white White	20/12/2100	21 m	3606480310836 3606480683077 3606480310904 <b>ISM14150</b> <b>ISM14170P</b> <b>ISM14170</b>
P83319 	With one compartment	Anodized Polar white White	20/18/2100	21 m	3606480311086 3606480683084 3606480311154 <b>ISM14350</b> <b>ISM14370P</b> <b>ISM14370</b>
P83320 	With two compartments	Anodized Polar white White	35/18/2100	21 m	3606480311260 3606480683091 3606480311345 <b>ISM14450</b> <b>ISM14470P</b> <b>ISM14470</b>

## Mini-trunking for the French market

Type	Colour	Dimensions A/B/C (mm)		Qty per package	EAN code	Ref. No.
<b>PVC mini-trunking</b>						
Mini-trunking including base profile with one, two or three compartments, and snap-fitted cover. Partition walls can be removed. With pre-punched mounting holes at 100 mm centres. Suitable for power and low voltage cables. Approved for single-insulated cables if TFT-IS (4020210) fastener is used. Intended for the French market only. Supplied in 2.1 m lengths. However, 2 m is communicated on the product label (French market demand). Material: PVC.						
P83321 	With one compartment	Polar white	20/12/2100	40 m	3606480731129	<b>ISM14120P</b>
P83323 	With two compartments	Polar white	30/12/2100	40 m	3606480731143	<b>ISM14220P</b>
P141435 	With two compartments	Polar white	35/15/2100	40 m	3606480731204	<b>ISM14720P</b>
P83324 	With two compartments	Polar white	35/18/2100	40 m	3606480731167	<b>ISM14420P</b>
P83325 	With two compartments	Polar white	45/18/2100	40 m	3606480731174	<b>ISM14520P</b>
P83326 	With three compartments	Polar white	60/25/2100	20 m	3606480731198	<b>ISM14620P</b>
<b>PVC mini-trunking with integrated cable retaining function</b>						
Mini-trunking including base profile with one compartment and snap-fitted cover. The base profile has an integrated cable retaining function, flexible at the cable entry, preventing cables from falling out of the base profile during installation. With pre-punched mounting holes at 100 mm centres. Suitable for power and low voltage cables. Approved for single-insulated cables if TFT-IS (4020210) fastener is used. Intended for the French market only. Supplied in 2.1 m lengths. However, 2 m is communicated on the product label (French market demand). Material: PVC.						
P141434 	With one compartment	Polar white	30/12/2100	40 m	3606480731150	<b>ISM14231P</b>
P141436 	With one compartment	Polar white	35/15/2100	40 m	3606480731211	<b>ISM14731P</b>
P141437 	With one compartment	Polar white	45/18/2100	40 m	3606480731181	<b>ISM14531P</b>
<b>PVC mini-trunking with bonding tape</b>						
Mini-trunking including base profile with one compartment and snap-fitted cover. With pre-punched mounting holes at 100 mm centres. Provided with bonding tape on the back of the base profile. Not approved for power cabling if the trunking is only fixed to the wall by the tape. If the fixing by tape is combined with screw-fixing, power cables may also be installed. Approved for single-insulated cables if TFT-IS (4020210) fastener is used. Intended for the French market only. Supplied in 2.1 m lengths. However, 2 m is communicated on the product label (French market demand). Material: PVC.						
P83321 	With one compartment	Polar white	20/12/2100	40 m	3606480731136	<b>ISM14126P</b>

## Accessories

Type	Colour	Dimensions A/B/C (mm)		Qty per package	EAN code	Ref. No.
<b>Internal corner</b>						
Internal corner to be snap-fitted onto the mini-trunking base. Material: PC/ABS.						
	For 12x20 mini-trunking	Polar white White Alu metallic	20/40/40	10	3606480683107 3606480310744 3606480310843	<b>ISM14101P</b> <b>ISM14101</b> <b>ISM14151</b>
	For 12x30 mini-trunking	Polar white White	32/40/40	10	3606480683114 3606480310928	<b>ISM14201P</b> <b>ISM14201</b>
	For 15x35 mini-trunking	Polar white	37/45/55	10	3606480694103	<b>ISM14701P</b>
	For 18x20 mini-trunking	Polar white White Alu metallic	20/45/45	10	3606480683121 3606480310997 3606480311093	<b>ISM14301P</b> <b>ISM14301</b> <b>ISM14351</b>
	For 18x35 mini-trunking	Polar white White Alu metallic	37/45/45	10	3606480683138 3606480311178 3606480311277	<b>ISM14401P</b> <b>ISM14401</b> <b>ISM14451</b>
	For 18x45 mini-trunking	Polar white White	47/45/45	10	3606480683145 3606480311369	<b>ISM14501P</b> <b>ISM14501</b>
	For 25x60 mini-trunking	Polar white White	62/53/53	10	3606480683152 3606480311444	<b>ISM14601P</b> <b>ISM14601</b>
	<b>External corner</b>					
External corner to be snap-fitted onto the mini-trunking base. Material: PC/ABS.						
	For 12x20 mini-trunking	Polar white White Alu metallic	22/36/36	10	3606480683169 3606480310751 3606480310850	<b>ISM14102P</b> <b>ISM14102</b> <b>ISM14152</b>
	For 12x30 mini-trunking	Polar white White	32/36/36	10	3606480683176 3606480310935	<b>ISM14202P</b> <b>ISM14202</b>
	For 15x35 mini-trunking	Polar white	37/39/39	10	3606480694110	<b>ISM14702P</b>
	For 18x20 mini-trunking	Polar white White Alu metallic	22/42/42	10	3606480683183 3606480311000 3606480311109	<b>ISM14302P</b> <b>ISM14302</b> <b>ISM14352</b>
	For 18x35 mini-trunking	Polar white White Alu metallic	37/42/42	10	3606480683190 3606480311185 3606480311284	<b>ISM14402P</b> <b>ISM14402</b> <b>ISM14452</b>
	For 18x45 mini-trunking	Polar white White	47/42/42	10	3606480683206 3606480311376	<b>ISM14502P</b> <b>ISM14502</b>
	For 25x60 mini-trunking	Polar white White	62/49/49	10	3606480683213 3606480311451	<b>ISM14602P</b> <b>ISM14602</b>
	<b>Adjustable internal corner</b>					
Adjustable internal corner 90° ±10°, to be snap-fitted onto the mini-trunking base. Material: PC/ABS.						
	For 12x20 mini-trunking	Polar white	25/41/41	10	3606481190192	<b>ISM14111P</b>
	For 12x30 mini-trunking	Polar white	34/41/41	10	3606481190239	<b>ISM14211P</b>
	For 15x35 mini-trunking	Polar white	39/47/47	10	3606481190338	<b>ISM14711P</b>
	For 18x35 mini-trunking	Polar white	39/53/53	10	3606481190260	<b>ISM14411P</b>
	For 18x45 mini-trunking	Polar white	50/53/53	10	3606481190284	<b>ISM14511P</b>
	For 25x60 mini-trunking	Polar white	66/67/67	10	3606481190314	<b>ISM14611P</b>
<b>Adjustable external corner</b>						
Adjustable external corner 90° ±10°, to be snap-fitted onto the mini-trunking base. Material: PC/ABS.						
	For 12x20 mini-trunking	Polar white	24/36/38	10	3606481190208	<b>ISM14112P</b>
	For 12x30 mini-trunking	Polar white	35/36/38	10	3606481190246	<b>ISM14212P</b>
	For 15x35 mini-trunking	Polar white	39/40/42	10	3606481190345	<b>ISM14712P</b>
	For 18x35 mini-trunking	Polar white	39/42/44	10	3606481190277	<b>ISM14412P</b>
	For 18x45 mini-trunking	Polar white	49/42/44	10	3606481190307	<b>ISM14512P</b>
	For 25x60 mini-trunking	Polar white	64/50/52	10	3606481190321	<b>ISM14612P</b>

P83921

P83922

P147146

P147140

Accessories

Type	Colour	Dimensions A/B/C (mm)		Qty per package	EAN code	Ref. No.
<b>Bend, 90°</b>						
90 degree bend to be used in junctions between horizontal and vertical applications. To be snap-fitted onto the mini-trunking base. Material: PC/ABS.						
For 12x20 mini-trunking	Polar white White Alu metallic	12/40/40		10	3606480683220 3606480310768 3606480310867	<b>ISM14109P</b> <b>ISM14103</b> <b>ISM14153</b>
For 12x30 mini-trunking	Polar white White	12/50/50		10	3606480683237 3606480310942	<b>ISM14209P</b> <b>ISM14203</b>
For 15x35 mini-trunking	Polar white	15/55/55		10	3606480694158	<b>ISM14709P</b>
For 18x20 mini-trunking	Polar white White Alu metallic	18/40/40		10	3606480683244 3606480311017 3606480311116	<b>ISM14309P</b> <b>ISM14303</b> <b>ISM14353</b>
For 18x35 mini-trunking	Polar white White Alu metallic	18/55/55		10	3606480683251 3606480311192 3606480311291	<b>ISM14409P</b> <b>ISM14403</b> <b>ISM14453</b>
For 18x45 mini-trunking	Polar white White	18/65/65		10	3606480683268 3606480311383	<b>ISM14509P</b> <b>ISM14503</b>
For 25x60 mini-trunking	Polar white White	24/80/80		10	3606480683275 3606480311468	<b>ISM14609P</b> <b>ISM14603</b>
<b>Stop end</b>						
Stop end to be snap-fitted at the end of the mini-trunking base. Material: PC/ABS.						
For 12x20 mini-trunking	Polar white White Alu metallic	22/15/13		10	3606480683282 3606480310775 3606480310874	<b>ISM14104P</b> <b>ISM14104</b> <b>ISM14154</b>
For 12x30 mini-trunking	Polar white White	32/15/13		10	3606480683299 3606480310959	<b>ISM14204P</b> <b>ISM14204</b>
For 15x35 mini-trunking	Polar white	37/15/16		10	3606480694127	<b>ISM14704P</b>
For 18x20 mini-trunking	Polar white White Alu metallic	22/15/19		10	3606480683305 3606480311024 3606480311123	<b>ISM14304P</b> <b>ISM14304</b> <b>ISM14354</b>
For 18x35 mini-trunking	Polar white White Alu metallic	37/15/19		10	3606480683312 3606480311208 3606480311307	<b>ISM14404P</b> <b>ISM14404</b> <b>ISM14454</b>
For 18x45 mini-trunking	Polar white White	47/15/19		10	3606480683329 3606480311390	<b>ISM14504P</b> <b>ISM14504</b>
For 25x60 mini-trunking	Polar white White	62/17/26		10	3606480683336 3606480311475	<b>ISM14604P</b> <b>ISM14604</b>







PR3921



PR3925

Accessories

Type	Colour	Dimensions A/B/C (mm)		Qty per package	EAN code	Ref. No.
<b>Joint cover piece</b>						
Joint cover piece to cover joints between mini-trunking covers. To be snap-fitted onto the mini-trunking base. Material: PC/ABS.						
For 12x20 mini-trunking	Polar white	22/22/13		10	3606480683343	<b>ISM14105P</b>
	White				3606480310782	<b>ISM14105</b>
	Alu metallic				3606480310881	<b>ISM14155</b>
For 12x30 mini-trunking	Polar white White	32/22/13		10	3606480683350 3606480310966	<b>ISM14205P</b> <b>ISM14205</b>
For 15x35 mini-trunking	Polar white	37/22/16		10	3606480694134	<b>ISM14705P</b>
For 18x20 mini-trunking	Polar white	22/22/19		10	3606480683367	<b>ISM14305P</b>
	White				3606480311031	<b>ISM14305</b>
	Alu metallic				3606480311130	<b>ISM14355</b>
For 18x35 mini-trunking	Polar white	37/22/19		10	3606480683374	<b>ISM14405P</b>
	White				3606480311215	<b>ISM14405</b>
	Alu metallic				3606480311314	<b>ISM14455</b>
For 18x45 mini-trunking	Polar white White	47/22/19		10	3606480683381 3606480311406	<b>ISM14505P</b> <b>ISM14505</b>
For 25x60 mini-trunking	Polar white White	62/22/26		10	3606480683398 3606480311482	<b>ISM14605P</b> <b>ISM14605</b>
<b>T-piece</b>						
T-piece to be used in T-junctions between mini-trunking of the same size. To be snap-fitted onto the mini-trunking base. Material: PC/ABS.						
For 12x20 mini-trunking	Polar white	12/40/58		10	3606480683404	<b>ISM14106P</b>
	White				3606480310799	<b>ISM14106</b>
	Alu metallic				3606480310898	<b>ISM14156</b>
For 12x30 mini-trunking	Polar white White	12/50/68		10	3606480683411 3606480310973	<b>ISM14206P</b> <b>ISM14206</b>
For 15x35 mini-trunking	Polar white	15/55/73		10	3606480694141	<b>ISM14706P</b>
For 18x20 mini-trunking	Polar white	18/40/58		10	3606480683428	<b>ISM14306P</b>
	White				3606480311048	<b>ISM14306</b>
	Alu metallic				3606480311147	<b>ISM14356</b>
For 18x35 mini-trunking	Polar white	18/55/73		10	3606480683435	<b>ISM14406P</b>
	White				3606480311222	<b>ISM14406</b>
	Alu metallic				3606480311321	<b>ISM14456</b>
For 18x45 mini-trunking	Polar white White	18/65/83		10	3606480683442 3606480311413	<b>ISM14506P</b> <b>ISM14506</b>
For 25x60 mini-trunking	Polar white White	24/80/98		10	3606480683459 3606480311499	<b>ISM14606P</b> <b>ISM14606</b>
<b>Branching piece</b>						
Branching piece to be used in T-junctions between mini-trunking of different sizes. To be snap-fitted onto the mini-trunking base. Material: PC/ABS.						
For 12x20–18x35 mini-trunking	Polar white	58/40/17		10	3606480683466	<b>ISM14407P</b>
	White				3606480311239	<b>ISM14407</b>
	Alu metallic				3606480311338	<b>ISM14457</b>
For 12x20 –18x45 mini-trunking	Polar white White	64/50/17		10	3606480683473 3606480311420	<b>ISM14507P</b> <b>ISM14507</b>
For 18x35–25x60 mini-trunking	Polar white White	79/65/24		10	3606480683480 3606480311505	<b>ISM14607P</b> <b>ISM14607</b>
<b>DCL branching piece</b>						
Branching piece for DCL to be used in T-junctions between mini-trunking and DCL trunking of sizes 12x20 or 12x30 mm. To be snap-fitted onto the mini-trunking base. Material: PC/ABS.						
For 12x20 mini-trunking with entry 12x20	Polar white	23/17/57		5	3606481190208	<b>ISM14191P</b>
For 12x30 mini-trunking with entry 12x20 or 12x30	Polar white	33/21/77		5	3606481190253	<b>ISM14291P</b>
For 15x35 mini-trunking with entry 12x20 or 12x30	Polar white	39/24/78		5	3606481190352	<b>ISM14791P</b>
For 18x45 mini-trunking with entry 12x20 or 12x30	Polar white	49/26/78		5	3606481190284	<b>ISM14491P</b>

P83926



P83923

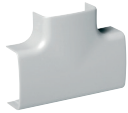

P83927



P147134



P147135



Accessories

Type	Colour	Dimensions A/B/C (mm)		Qty per package	EAN code	Ref. No.
------	--------	--------------------------	---	-----------------	----------	----------

**DCL center device**  
DCL device for luminaire, delivered with fixation base, cover, plug and socket for lamp contact and hook.  
Material: PC/ABS.

DCL center device with entry 12x20 or 12x30	Polar white	48/115/115		5	3606481190208	<b>ISM14190P</b>
---	-------------	------------	--	---	---------------	------------------

**Fly-over**  
Fly-over to be used in combination with T-piece or branching piece. Intended to secure separation between compartments when single-insulated cable is used.  
Material: ABS

For 18x35 mini-trunking	White	13/30/30		10	3606480311246	<b>ISM14408</b>
-------------------------	-------	----------	--	----	---------------	-----------------

For 25x60 mini-trunking	White	20/55/55		10	3606480311512	<b>ISM14608</b>
-------------------------	-------	----------	--	----	---------------	-----------------

Compatible accessories, including Thorsman range products

**Cutting shears**

Cutting shears for PVC and PC/ABS material. To be used when cutting mini-trunking, front covers, cable shelves or other plastic length material, instead of using a saw.  
Material: Steel.

Cutting shears	Orange	230/22/80		1	3606480028472	<b>ISM10908</b>
----------------	--------	-----------	--	---	---------------	-----------------

**Cable retainer**

Clamp intended to hold cables in place in the mini-trunking.  
Material: PA.

TTM-KL26	Black	7.5/26/22		10	7315885401600	<b>5401600</b>
----------	-------	-----------	--	----	---------------	----------------

TTM-KL36	Black	9.5/36/25		10	7315885401617	<b>5401610</b>
----------	-------	-----------	--	----	---------------	----------------

**Installation screw with cup washer**

Installation screw with cross-slotted head type PH2. Sharp point, fully threaded. High pitch for quick mounting. Provided with a cup washer for screw-head protection. To be used when installing single-insulated wire in the trunking.  
Material: Hardened steel, electroplated, and PP.

TFT-IS5x32	—	Ø5/32		100	7332418018203	<b>4020210</b>
------------	---	-------	--	-----	---------------	----------------

**Nail plug**

Nail plug with nail for through installation. Suitable for use in concrete, stone, lightweight concrete, expanded clay, hollow bricks and blocks, solid bricks and plasterboard.  
Material: PA.

TPS-6/5x35	Clear	Ø 6/5/35		100	7315881150007	<b>1150002</b>
------------	-------	----------	--	-----	---------------	----------------

Accessories for Alréa

**Adaptor for Alréa wiring device**

Adaptor kit including wiring device frame, spacer with cable separation function and stop end. Suitable for power and data/ telecom outlets and switches of the French market wiring device range Alréa.  
Material: PC/ABS.

Single adaptor 12x20	Polar white	96/30/62		5	3606480632716	<b>ISM14180P</b>
----------------------	-------------	----------	--	---	---------------	------------------

Single adaptor 12x30	Polar white	101/30/62		5	3606480632747	<b>ISM14280P</b>
----------------------	-------------	-----------	--	---	---------------	------------------

Single adaptor 15x35	Polar white	106/30/62		5	3606480632938	<b>ISM14780P</b>
----------------------	-------------	-----------	--	---	---------------	------------------

Single adaptor 18x35	Polar white	106/30/62		5	3606480632792	<b>ISM14480P</b>
----------------------	-------------	-----------	--	---	---------------	------------------

Single adaptor 18x45	Polar white	116/30/62		5	3606480632822	<b>ISM14580P</b>
----------------------	-------------	-----------	--	---	---------------	------------------

Single adaptor 25x60	Polar white	131/30/62		5	3606480632846	<b>ISM14680P</b>
----------------------	-------------	-----------	--	---	---------------	------------------



## Pre-punched hole dimensions (mm)

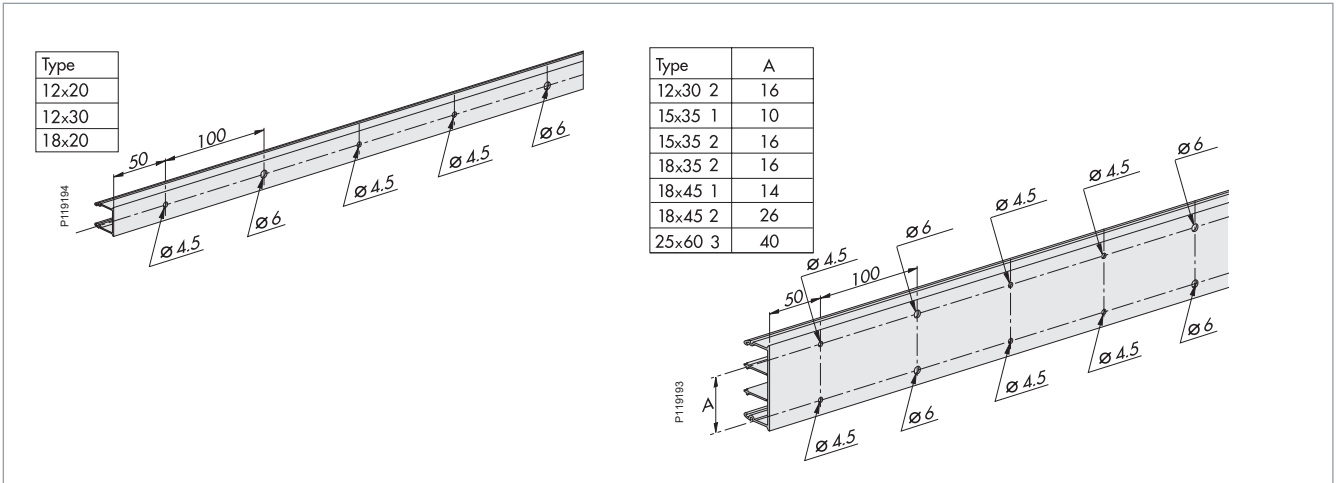

## Cable capacity

Comp.	Max. cable Ø mm	Cross section area mm <sup>2</sup>	Cable capacity mm <sup>2</sup>				Number of conductors			
			40%	50%	60%		1,5 mm <sup>2</sup>	2,5 mm <sup>2</sup>	4 mm <sup>2</sup>	UTP&FTP Cat 6 Ø 6 mm
12x20, 1 comp. 1	10	148	59	74	89		7	5	4	2
12x30, 1 comp. 1	10	190	76	95	114		10	8	6	3
12x30, 2 comp. 1	9	115	46	57	69		5	4	3	2
2	9	115	46	57	69		5	4	3	2
15x35, 1 comp. 1	12	278	111	139	166		14	10	8	5
15x35, 2 comp. 1	11	164	65	82	98		7	5	4	2
2	11	164	65	82	98		7	5	4	2
18x20, 1 comp. 1	15	246	98	123	148		12	9	7	4
18x35, 2 comp. 1	12.5	201	80	100	120		9	7	5	3
2	12.5	201	80	100	120		9	7	5	3
18x45, 1 comp. 1	15	486	194	243	291		26	20	14	8
18x45, 2 comp. 1	14	278	111	139	167		13	10	7	4
2	14	278	111	139	167		13	10	7	4
25x60, 3 comp. 1	15	339	135	170	203		15	11	9	5
2	17	389	135	170	203		15	11	9	5
3	15	339	135	170	203		15	11	9	5

## Exploded view

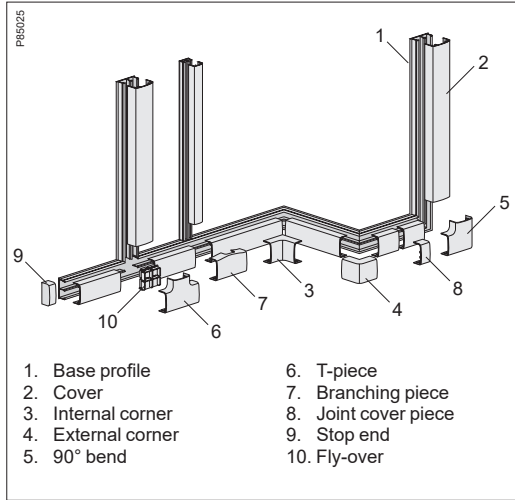

1. Base profile
2. Cover
3. Internal corner
4. External corner
5. 90° bend
6. T-piece
7. Branching piece
8. Joint cover piece
9. Stop end
10. Fly-over

## Design and dimensions (mm), material

12x20, 1 comp.	12x30, 1 comp.	12x30, 2 comp.	15x35, 1 comp.	15x35, 2 comp.	18x20, 1 comp.
Aluminium	PVC*	PVC	PVC**	PVC	Aluminium
PVC*	PVC**	PVC	PVC**	PVC	PVC*
PC/ABS*					PC/ABS*

18x35, 2 comp.	18x45, 1 comp.	18x45, 2 comp.	25x60, 3 comp.
Aluminium	PVC**	PVC	PVC
PVC	PVC**	PVC	PVC
PC/ABS			PC/ABS

\*Also available with bonding tape.

\*\* Available with integrated cable retaining function.

## Technical and material data

Aluminium	Surface treatment:	Natural anodized or powder coated
	Colours:	<ul style="list-style-type: none"> <li>• Polar white (RAL 9003)</li> <li>• White (RAL 9010)</li> </ul>
PVC	Characteristics:	Rigid, self-extinguishing, cadmium-free, lead-free
	Colours:	<ul style="list-style-type: none"> <li>• Polar white (RAL 9003)</li> <li>• White (RAL 9010)</li> </ul>
	Fire/smoke toxicity:	M1 acc. to French standard NF P 92501
PC/ABS	Characteristics:	Halogen-free
	Trunking:	Self-extinguishing, cadmium-free, lead-free
	Access.:	Cadmium-free, lead-free
	Colours:	<ul style="list-style-type: none"> <li>• Polar white (RAL 9003)</li> <li>• White (RAL 9010)</li> <li>• Aluminium metallic (painted)</li> </ul>
ABS	Characteristics:	Halogen-free
	Colours:	<ul style="list-style-type: none"> <li>• Polar white (RAL 9003)</li> <li>• White (RAL 9010)</li> </ul>
Delivery lengths		2.1 metres

## Standards and certificates

The products comply with the standards:	<ul style="list-style-type: none"> <li>• EN 50085-1:2005</li> <li>• EN 50085-2-1:2006</li> </ul>
The products satisfy the provisions for CE marking according to the Low Voltage Directive 73/23/EEC and 98/68/EEC.	
The products comply with the RoHS directive 2002/95/EC (Restriction of Hazardous Substances)	
Classification acc. to EN 50085-1:	
6.2 Resistance to impact for installation and application	2.0 J
6.3 Min. storage and transport temperature	-25°C
6.3 Min. installation and application temp.	-5°C
6.3 Max. application temperature	+60°C
6.4 Resistance to flame propagation	Non-flame propagating
6.5 Electrical continuity characteristic	Without continuity
6.6 Electrical insulating characteristic	With electrical insulation
6.7 Degree of protection provided by encl.	IP40
6.9 System access cover retention	With a tool
6.101 Installation position	Wall-fixed
Rated Voltage	400 V AC
External mechanical impact	IK07

1150002.....	16	ISM14354.....	14
4020210.....	16	ISM14355.....	15
5401600.....	16	ISM14356.....	15
5401610.....	16	ISM14370.....	11
<b>ISM</b>		ISM14370P.....	11
ISM10908.....	16	ISM14400.....	10
ISM14100.....	10	ISM14400P.....	10
ISM14100P.....	10	ISM14401.....	13
ISM14101.....	13	ISM14401P.....	13
ISM14101P.....	13	ISM14402.....	13
ISM14102.....	13	ISM14402P.....	13
ISM14102P.....	13	ISM14403.....	14
ISM14103.....	14	ISM14404.....	14
ISM14104.....	14	ISM14404P.....	14
ISM14104P.....	14	ISM14405.....	15
ISM14105.....	15	ISM14405P.....	15
ISM14105P.....	15	ISM14406.....	15
ISM14106.....	15	ISM14406P.....	15
ISM14106P.....	15	ISM14407.....	15
ISM14109P.....	14	ISM14407P.....	15
ISM14111P.....	13	ISM14408.....	16
ISM14112P.....	13	ISM14409P.....	14
ISM14120P.....	12	ISM14411P.....	13
ISM14125.....	10	ISM14412P.....	13
ISM14125P.....	10	ISM14420P.....	12
ISM14126P.....	12	ISM14430.....	11
ISM14130.....	11	ISM14430P.....	11
ISM14130P.....	11	ISM14440.....	10
ISM14135.....	11	ISM14450.....	11
ISM14135P.....	11	ISM14451.....	13
ISM14140.....	10	ISM14452.....	13
ISM14145.....	10	ISM14453.....	14
ISM14150.....	11	ISM14454.....	14
ISM14151.....	13	ISM14455.....	15
ISM14152.....	13	ISM14456.....	15
ISM14153.....	14	ISM14457.....	15
ISM14154.....	14	ISM14470.....	11
ISM14155.....	15	ISM14470P.....	11
ISM14156.....	15	ISM14480P.....	16
ISM14170.....	11	ISM14491P.....	15
ISM14170P.....	11	ISM14500.....	10
ISM14180P.....	16	ISM14500P.....	10
ISM14190P.....	16	ISM14501.....	13
ISM14191P.....	15	ISM14501P.....	13
ISM14200.....	10	ISM14502.....	13
ISM14200P.....	10	ISM14502P.....	13
ISM14201.....	13	ISM14503.....	14
ISM14201P.....	13	ISM14504.....	14
ISM14202.....	13	ISM14504P.....	14
ISM14202P.....	13	ISM14505.....	15
ISM14203.....	14	ISM14505P.....	15
ISM14204.....	14	ISM14506.....	15
ISM14204P.....	14	ISM14506P.....	15
ISM14205.....	15	ISM14507.....	15
ISM14205P.....	15	ISM14507P.....	15
ISM14206.....	15	ISM14509P.....	14
ISM14206P.....	15	ISM14511P.....	13
ISM14209P.....	14	ISM14512P.....	13
ISM14211P.....	13	ISM14520P.....	12
ISM14212P.....	13	ISM14530P.....	10
ISM14220P.....	12	ISM14531P.....	12
ISM14225P.....	10	ISM14540.....	10
ISM14230P.....	10	ISM14580P.....	16
ISM14231P.....	12	ISM14600.....	10
ISM14235P.....	11	ISM14600P.....	10
ISM14240.....	10	ISM14601.....	13
ISM14280P.....	16	ISM14601P.....	13
ISM14291P.....	15	ISM14602.....	13
ISM14300.....	10	ISM14602P.....	13
ISM14300P.....	10	ISM14603.....	14
ISM14301.....	13	ISM14604.....	14
ISM14301P.....	13	ISM14604P.....	14
ISM14302.....	13	ISM14605.....	15
ISM14302P.....	13	ISM14605P.....	15
ISM14303.....	14	ISM14606.....	15
ISM14304.....	14	ISM14606P.....	15
ISM14304P.....	14	ISM14607.....	15
ISM14305.....	15	ISM14607P.....	15
ISM14305P.....	15	ISM14608.....	16
ISM14306.....	15	ISM14609P.....	14
ISM14306P.....	15	ISM14611P.....	13
ISM14309P.....	14	ISM14612P.....	13
ISM14325.....	10	ISM14620P.....	12
ISM14325P.....	10	ISM14630.....	11
ISM14330.....	11	ISM14630P.....	11
ISM14330P.....	11	ISM14640.....	10
ISM14335.....	11	ISM14680P.....	16
ISM14335P.....	11	ISM14700P.....	10
ISM14340.....	10	ISM14701P.....	13
ISM14345.....	10	ISM14702P.....	13
ISM14350.....	11	ISM14704P.....	14
ISM14351.....	13	ISM14705P.....	15
ISM14352.....	13	ISM14706P.....	15
ISM14353.....	14	ISM14709P.....	14

---

ISM14711P .....	13
ISM14712P .....	13
ISM14720P .....	12
ISM14730P .....	10
ISM14731P .....	12
ISM14780P .....	16
ISM14791P .....	15





# Green Premium™

Endorsing the most eco-friendly products in the industry



Green Premium is the only label that allows you to effectively develop and promote an environmental policy whilst preserving your business efficiency. This ecolabel guarantees compliance with the most up-to-date environmental regulations, but it does more than this.

Over 75% of Schneider Electric manufactured products have been awarded the Green Premium ecolabel



Discover what we mean by green ....

**Check your products!**

Schneider Electric's Green Premium ecolabel is committed to offering transparency, by disclosing extensive and reliable information related to the environmental impact of its products:

#### **RoHS**

Schneider Electric products are subject to RoHS requirements at a worldwide level, even for the many products that are not required to comply with the terms of the regulation. Compliance certificates are available for products that fulfil the criteria of this European initiative, which aims to eliminate hazardous substances.

#### **REACH**

Schneider Electric applies the strict REACH regulation on its products at a worldwide level, and discloses extensive information concerning the presence of SVHC (Substances of Very High Concern) in all of these products.

#### **PEP: Product Environmental Profile**

Schneider Electric publishes the most complete set of environmental data, including carbon footprint and energy consumption data for each of the lifecycle phases on all of its products, in compliance with the ISO 14025 PEP ecopassport program. PEP is especially useful for monitoring, controlling, saving energy, and/or reducing carbon emissions.

#### **EoLI: End of Life Instructions**

Available at the click of a button, these instructions provide:

- Recyclability rates for Schneider Electric products.
- Guidance to mitigate personnel hazards during the dismantling of products and before recycling operations.
- Parts identification for recycling or for selective treatment, to mitigate environmental hazards/ incompatibility with standard recycling processes.





**Schneider Electric Industries SAS**

35, rue Joseph Monier  
CS 30323  
92506 Rueil Malmaison Cedex  
France

RCS Nanterre 954 503 439  
Capital social 896 313 776 €  
[www.schneider-electric.com](http://www.schneider-electric.com)

11-2020  
LSB03224EN

© 2020 - Schneider Electric. All Rights Reserved.  
All trademarks are owned by Schneider Electric Industries SAS or its affiliated companies.

This document has been  
printed on recycled paper

