

# Product Data Sheet

## GW50427

GW FIT Range



Systems of accessories for electrical installations used for residential, tertiary and industrial applications. The system consists of fasteners for pipes and cables, cable fittings, accessories for rigid pipes (RK Series) and flexible conduit (DF Series). The system include also a wide variety of cable ties (52FS Range) and terminal blocks (44 Range).

Colour	Grey RAL 7035	IP degree	IP44
Material	Flexible polymer	For external conduits (mm)	50
Mounting hole Ø (mm)	48	Glow Wire Test	750 °C
Operating temperature	-5 +60 °C	Electrocod	21221
Standard	EN 61386-1 - EN 60670-1 (as applicable)		

### BEHAVIOUR WITH CHEMICAL AND ATMOSPHERIC AGENTS

Saline solution	Solvents			Mineral oil	UV rays
	Hexane	Benzol	Acetone		
Resistant	Not resistant	Limited resistance	Not resistant	Resistant	Resistant

### DIMENSIONAL

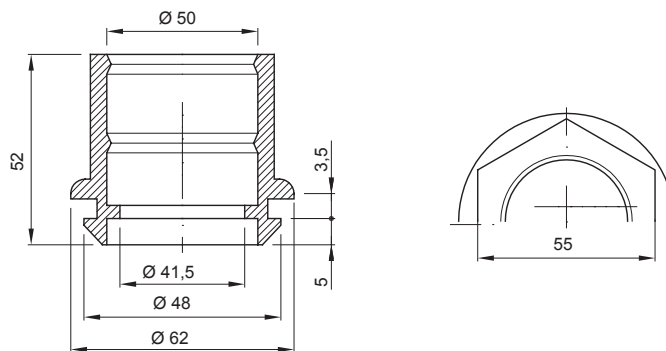

### TECHNICAL SYMBOLOGY

**IP**

IP44

**GWT**

750 °C



-5 +60 °C

### STANDARDS/APPROVALS

