

PKS 95 10 CUGALSN (472 437)

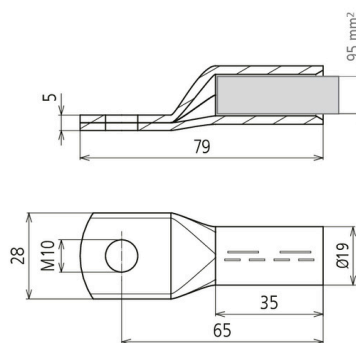

Figure without obligation



Crimped cable lug according to DIN 46235 with nickel barrier layer to avoid whisker formation.

Type	PKS 95 10 CUGALSN
Part No.	472 437 NEW
Material	Cu/gal (Ni)Sn
Lightning impulse current (10/350 µs) Cugal (Ni)Sn 95 mm ² (Rm/Rf) / stainless steel 40x10 mm	1HEXIIIC 100 kA (non-sparking) T4
Max. short-circuit current (AC 50 Hz / DC / 5 s) Cugal (Ni)Sn 95 mm ² (Rm/Rf) / StSt 40x10 mm	3100 A / T4
Max. surface temperature T4	135 °C
Cable lug hole	M10
Conductor cross-section	95 mm ²
Weight	93 g
Customs tariff number	85389099
GTIN	4013364470583
PU	3 Stk

Note: Non-sparking only ensured in connection with PAS EX ...!

We reserve the right to introduce changes in performance, configuration and technology, dimensions, weights and materials in the course of technical progress. The figures are shown without obligation.