

# Oil-resistant Proximity Sensors E2ER/E2ERZ

Preliminary Version

## Proximity Sensors That Withstand Cutting Oil to Reduce Failures Caused by Ingress of Cutting Oil

CE

- Fluororesin cable that withstands cutting oil.
- A sealing method that eliminates gaps at cable joints and the resin filling work together to block ingress of cutting oil.
- IP67G \* degree of protection (JIS C0920 Annex 1).

Refer to the *Safety Precautions* on page 8.

\* The IP67G is the degree of protection which is defined according to the JIS (Japanese Industrial Standards).  
The IP67 indicates the same level of protection as defined by the IEC, and the G indicates that a device has resistance to oil.



For the most recent information on models that have been certified for safety standards, refer to your OMRON website.

## Features

### Fluororesin Outer Cable Sheath

Fluororesin, which is not deteriorated by either water-insoluble or water-soluble cutting oils, is used for the cable sheath.

This prevents penetration of cutting oils into the cable.

Fluororesin Sheath

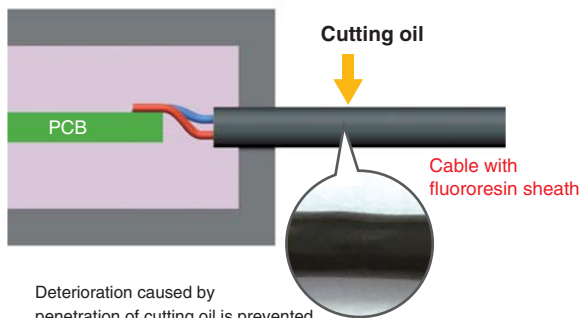

### Heat-Sealing Method

Fluoro components with high bondability and a melting point close to fluororesin cables are heat-welded. This blocks the ingress of cutting oil from the joined surfaces.

Heat-welding Sealing

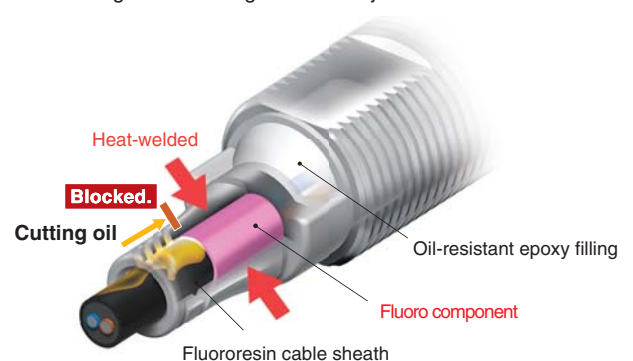

## Applications

### Detection of Cylinders

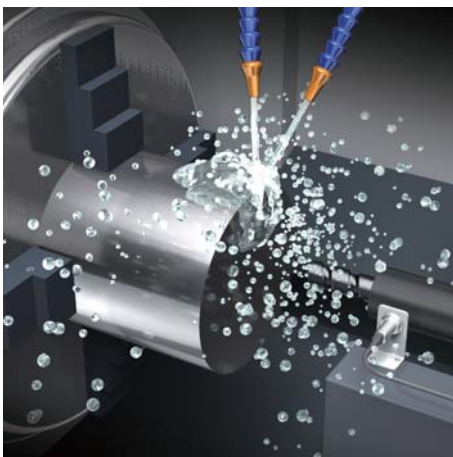

### Detection of Cutting Workpieces



## Ordering Information

### Sensors

Standard Proximity Sensors [Refer to *Dimensions* on page 10.]

Appearance	Sensing distance			Connection method	Cable specifications	Model	
						Operation mode: NO	Operation mode: NC
	M8	2 mm			Pre-wired (2 m)	E2ER-X2D1 2M *	E2ER-X2D2 2M *
					M12 Pre-wired connector (0.3 m)	E2ER-X2D1-M1TGJ 0.3M	E2ER-X2D2-M1TGJ 0.3M
	M12	3 mm			Pre-wired (2 m)	E2ER-X3D1 2M *	E2ER-X3D2 2M *
					M12 Pre-wired connector (0.3 m)	E2ER-X3D1-M1TGJ 0.3M	E2ER-X3D2-M1TGJ 0.3M
	M18	7 mm			Pre-wired (2 m)	E2ER-X7D1 2M *	E2ER-X7D2 2M *
					M12 Pre-wired connector (0.3 m)	E2ER-X7D1-M1TGJ 0.3M	E2ER-X7D2-M1TGJ 0.3M
	M30	10 mm			Pre-wired (2 m)	E2ER-X10D1 2M *	E2ER-X10D2 2M *
					M12 Pre-wired connector (0.3 m)	E2ER-X10D1-M1TGJ 0.3M	E2ER-X10D2-M1TGJ 0.3M

\* Models with 5-m cable length are also available with "5M" suffix. (Example: E2ER-X2D1 5M)

Chip-immune Proximity Sensors [Refer to *Dimensions* on page 10.]

Appearance	Sensing distance			Connection method	Cable specifications	Model	
						Operation mode: NO	Operation mode: NC
	M12	2 mm			Pre-wired (2 m)	E2ERZ-X2D1 2M *	E2ERZ-X2D2 2M *
					M12 Pre-wired connector (0.3 m)	E2ERZ-X2D1-M1TGJ 0.3M	E2ERZ-X2D2-M1TGJ 0.3M
	M18	4 mm			Pre-wired (2 m)	E2ERZ-X4D1 2M *	E2ERZ-X4D2 2M *
					M12 Pre-wired connector (0.3 m)	E2ERZ-X4D1-M1TGJ 0.3M	E2ERZ-X4D2-M1TGJ 0.3M
	M30	8 mm			Pre-wired (2 m)	E2ERZ-X8D1 2M *	E2ERZ-X8D2 2M *
					M12 Pre-wired connector (0.3 m)	E2ERZ-X8D1-M1TGJ 0.3M	E2ERZ-X8D2-M1TGJ 0.3M

\* Models with 5-m cable length are also available with "5M" suffix. (Example: E2ERZ-X2D1 5M)

### Accessories (Sold Separately)

#### Sensor I/O Connectors (M12, Sockets on One Cable End)

(Models for Pre-wired Connectors) A Sensor I/O Connector is not provided with the Sensor. It must be ordered separately as required.

Appearance	Cable diameter (mm)	Cable length	Sensor I/O Connector model number	Applicable Proximity Sensor model number
Straight, Smartclick connector 	4 dia.	2 m	XS5FR-D423-D80-RB1	E2ER-X□D□-M1TGJ E2ERZ-X□D□-M1TGJ
		5 m	XS5FR-D423-G80-RB1	

**Note:** Refer to the XS5□R datasheet (Cat. No. G122-E1) for connector details and for information on cables with connectors on both ends.

# Ratings and Specifications

## Standard Proximity Sensors

Size		M8	M12	M18	M30
Shielded		Shielded			
Item	Model	E2ER-X2D□	E2ER-X3D□	E2ER-X7D□	E2ER-X10D□
Sensing distance		2 mm ±10%	3 mm ±10%	7 mm ±10%	10 mm ±10%
Setting distance *1		0 to 1.6 mm	0 to 2.4 mm	0 to 5.6 mm	0 to 8 mm
Differential travel		15% max. of sensing distance	10% max. of sensing distance		
Detectable object		Ferrous metal (The sensing distance decreases with non-ferrous metal. Refer to <i>Engineering Data</i> on page 5.			
Standard sensing object		Iron, 8 × 8 × 1 mm	Iron, 12 × 12 × 1 mm	Iron, 18 × 18 × 1 mm	Iron, 30 × 30 × 1 mm
Response frequency *2		1.5 kHz	1 kHz	0.5 kHz	0.4 kHz
Power supply voltage (operating voltage range)		12 to 24 VDC, ripple (p-p): 10% max. (10 to 30 VDC)			
Leakage current		0.8 mA max.			
Control output	Load current	3 to 100 mA			
	Residual voltage	3 V max. (Load current: 100 mA, Cable length: 2 m)			
Indicators		D1 Models: Operation indicator (red), Setting indicator (green) D2 Models: Operation indicator (red)			
Operation mode (with sensing object approaching)		D1 Models: NO    Refer to the timing charts under <i>I/O Circuit Diagrams</i> on page 7 for details. D2 Models: NC			
Protection circuits		Surge suppressor, Load short-circuit protection			
Ambient temperature range		Operating: -25 to 70°C, Storage: -40 to 85°C (with no icing or condensation)			
Ambient humidity range		Operating and Storage: 35% to 95% (with no condensation)			
Temperature influence		±15% max. of sensing distance at 23°C in the temperature range of -25 to 70°C	±10% max. of sensing distance at 23°C in the temperature range of -25 to 70°C		
Voltage influence		±1% max. of sensing distance at rated voltage in the rated voltage ±15% range			
Insulation resistance		50 MΩ min. (at 500 VDC) between current-carrying parts and case			
Dielectric strength		1,000 VAC, 50/60 Hz for 1 minute between current-carrying parts and case			
Vibration resistance (destruction)		10 to 55 Hz, 1.5-mm double amplitude for 2 hours each in X, Y, and Z directions			
Shock resistance (destruction)		500 m/s <sup>2</sup> 10 times each in X, Y, and Z directions	1,000 m/s <sup>2</sup> 10 times each in X, Y, and Z directions		
Degree of protection		IP67 (IEC 60529) and IP67G *3 (JIS C0920 Annex 1)			
Connecting method		Pre-wired Models (Standard cable length: 2 m) and Pre-wired Connector Models (Standard cable length: 300 mm)			
Weight (packed state)	Pre-wired Models	Approx. 60 g	Approx. 70 g	Approx. 130 g	Approx. 175 g
	Pre-wired Connector Models	Approx. 45 g	Approx. 40 g	Approx. 70 g	Approx. 110 g
Materials	Case	Stainless steel (SUS303)	Nickel-plated brass		
	Sensing surface	Polybutylene terephthalate (PBT)			
	Clamping nuts	Nickel-plated brass			
	Toothed washer	Zinc-plated iron			
Accessories		Instruction manual			

\*1. Use the Sensor within the range in which the setting indicator (green LED) is ON (except D2 Models).

\*2. The response frequency is an average value.

Measurement conditions are as follows: standard sensing object, a distance of twice the standard sensing object, and a set distance of half the sensing distance.

\*3. The IP67G is the degree of protection which is defined according to the JIS (Japanese Industrial Standards).

The IP67 indicates the same level of protection as defined by the IEC, and the G indicates that a device has resistance to oil.

## Chip-immune Proximity Sensors

Size		M12	M18	M30
Shielded		Shielded		
Item	Model	E2ERZ-X2D□	E2ERZ-X4D□	E2ERZ-X8D□
Sensing distance		2 mm ±10%	4 mm ±10%	8 mm ±10%
Setting distance *1		0 to 1.6 mm	0 to 3.2 mm	0 to 6.4 mm
Differential travel		20% max. of sensing distance		
Detectable object		Ferrous metal (The sensing distance decreases with non-ferrous metal. Refer to <i>Engineering Data</i> on page 5.		
Standard sensing object		Iron, 12 × 12 × 1 mm	Iron, 30 × 30 × 1 mm	Iron, 54 × 54 × 1 mm
Response frequency *2		200 Hz	100 Hz	30 Hz
Power supply voltage (operating voltage range)		12 to 24 VDC, ripple (p-p): 10% max. (10 to 30 VDC)		
Leakage current		0.8 mA max.		
Control output	Load current	3 to 100 mA		
	Residual voltage	3 V max. (Load current: 100 mA, Cable length: 2 m)		
Indicators		D1 Models: Operation indicator (red), Setting indicator (green) D2 Models: Operation indicator (red)		
Operation mode (with sensing object approaching)		D1 Models: NO    Refer to the timing charts under <i>I/O Circuit Diagrams</i> on page 7 for details. D2 Models: NC		
Protection circuits		Surge suppressor, Load short-circuit protection		
Ambient temperature range		Operating and Storage: 0 to 50°C (with no icing or condensation)		
Ambient humidity range		Operating and Storage: 35% to 95% (with no condensation)		
Temperature influence		±20% max. of sensing distance at 23°C in the temperature range of 0 to 50°C		
Voltage influence		±2.5% max. of sensing distance at rated voltage in the rated voltage ±10% range		
Insulation resistance		50 MΩ min. (at 500 VDC) between current-carrying parts and case		
Dielectric strength		1,000 VAC, 50/60 Hz for 1 minute between current-carrying parts and case		
Vibration resistance (destruction)		10 to 55 Hz, 1.5-mm double amplitude for 2 hours each in X, Y, and Z directions		
Shock resistance (destruction)		1,000 m/s <sup>2</sup> 10 times each in X, Y, and Z directions		
Degree of protection		IP67 (IEC 60529) and IP67G *3 (JIS C0920 Annex 1)		
Connecting method		Pre-wired Models (Standard cable length: 2 m) and Pre-wired Connector Models (Standard cable length: 300 mm)		
Weight (packed state)	Pre-wired Models	Approx. 70 g	Approx. 160 g	Approx. 220 g
	Pre-wired Connector Models	Approx. 40 g	Approx. 90 g	Approx. 160 g
Materials	Case	Nickel-plated brass		
	Sensing surface	Polybutylene terephthalate (PBT)		
	Clamping nuts	Zinc-plated iron		
	Toothed washer	Zinc-plated iron		
Accessories		Instruction manual		

\*1. Use the Sensor within the range in which the setting indicator (green LED) is ON (except D2 Models).

\*2. The response frequency is an average value.

Measurement conditions are as follows: standard sensing object, a distance of twice the standard sensing object, and a set distance of half the sensing distance.

\*3. The IP67G is the degree of protection which is defined according to the JIS (Japanese Industrial Standards).

The IP67 indicates the same level of protection as defined by the IEC, and the G indicates that a device has resistance to oil.

# Engineering Data (Reference Value)

## Sensing Area

### Standard Proximity Sensors

#### E2ER-X□D□

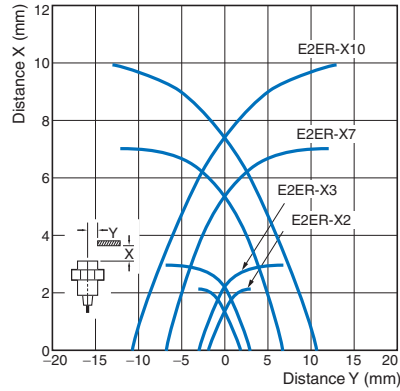

### Chip-immune Proximity Sensors

#### E2ERZ-X□D□

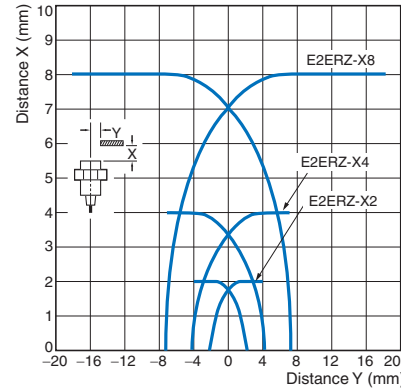

## Influence of Sensing Object Size and Material

### Standard Proximity Sensors

#### E2ER-X2

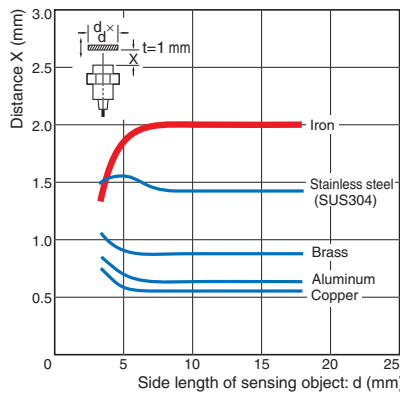

#### E2ER-X3

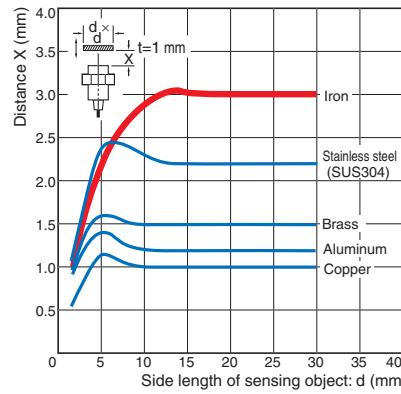

#### E2ER-X7

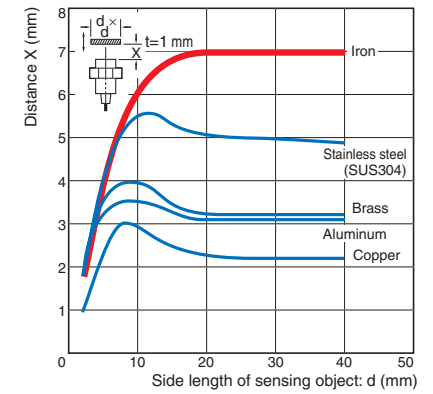

#### E2ER-X10

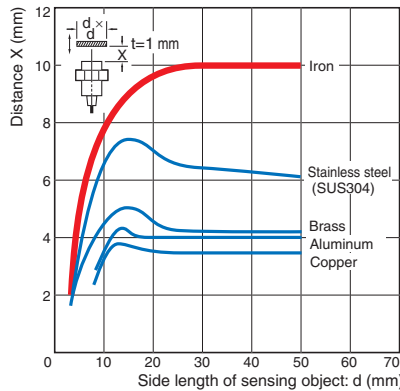

### Chip-immune Proximity Sensors

#### E2ERZ-X2

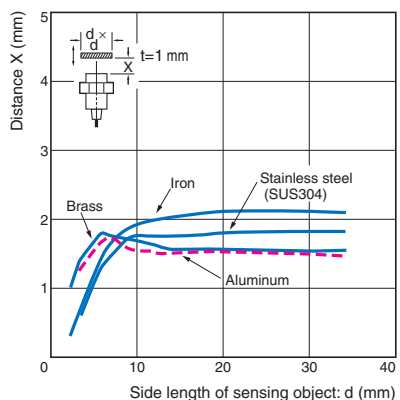

#### E2ERZ-X4

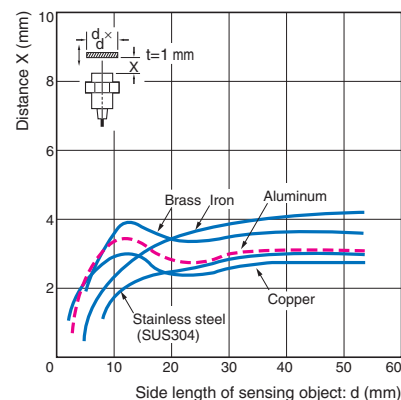

#### E2ERZ-X8

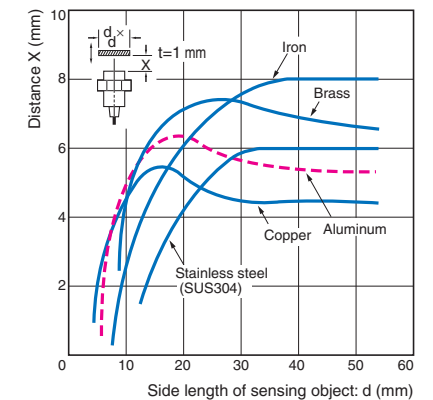

Leakage Current

Standard Proximity Sensors

E2ER-X□D□

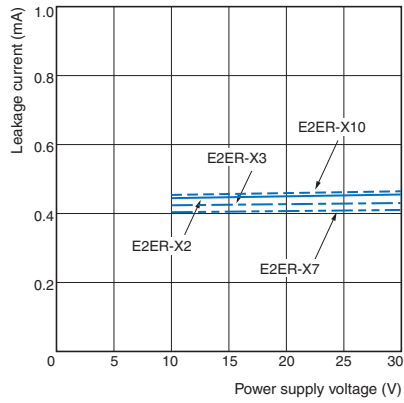

Chip-immune Proximity Sensors

E2ERZ-X□D□

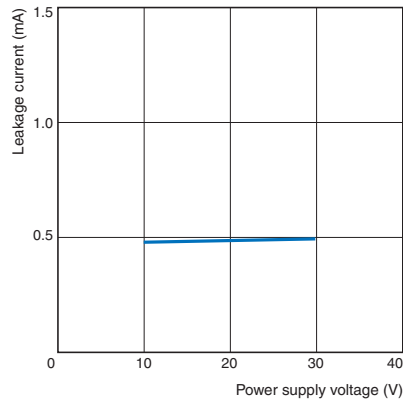

Residual Output Voltage

Standard Proximity Sensors / Chip-immune Proximity Sensors

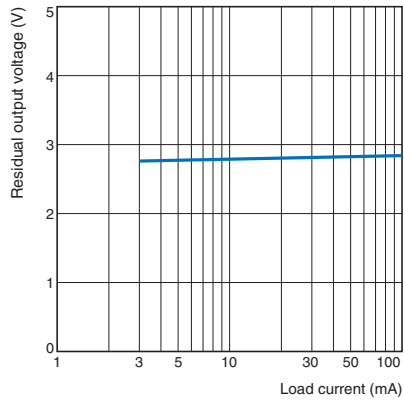

# Dimensions

(Unit: mm)

Tolerance class IT16 applies to dimensions in this data sheet unless otherwise specified.

## Pre-wired Models

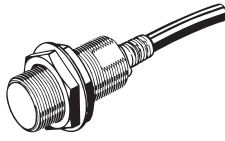

### E2ER-X2D□

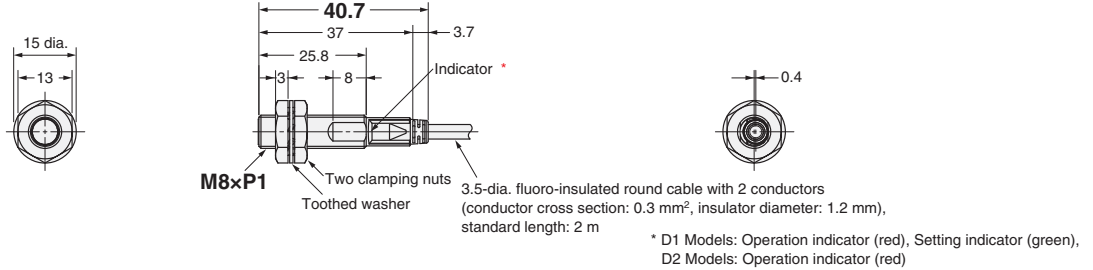

### E2ER-X3D□ E2ERZ-X2D□

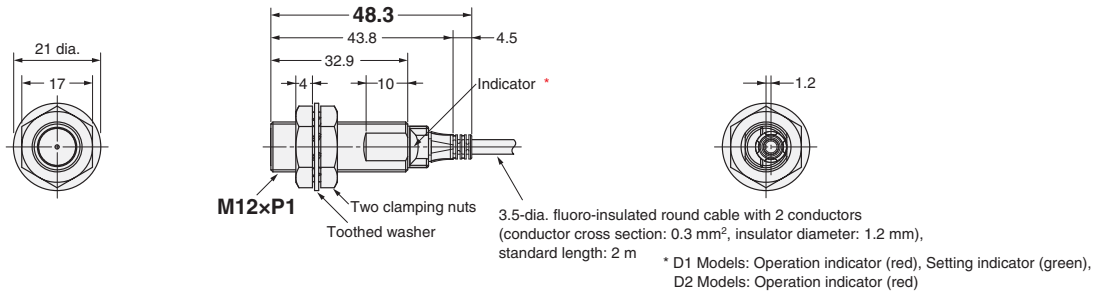

### E2ER-X7D□ E2ERZ-X4D□

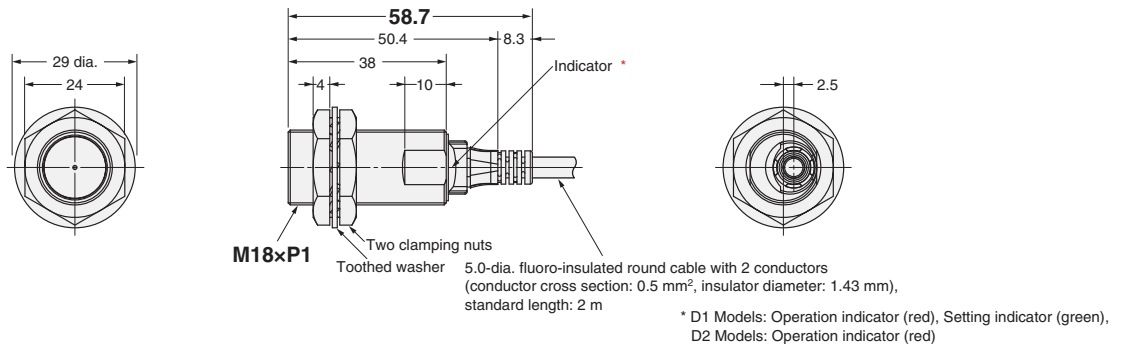

### E2ER-X10D□ E2ERZ-X8D□

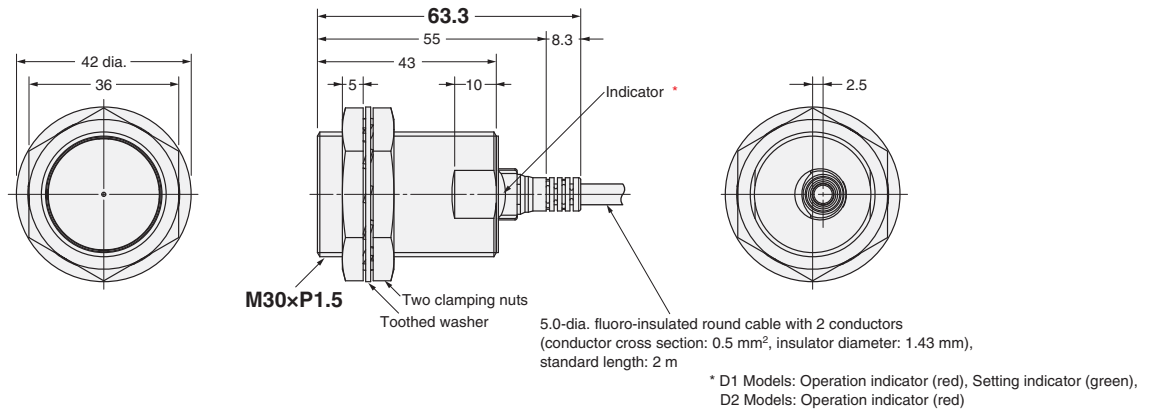

## Mounting Hole Dimensions

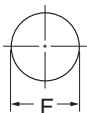

Dimension	M8	M12	M18	M30
F (mm)	8.5 <sup>+0.5</sup> <sub>0</sub> dia.	12.5 <sup>+0.5</sup> <sub>0</sub> dia.	18.5 <sup>+0.5</sup> <sub>0</sub> dia.	30.5 <sup>+0.5</sup> <sub>0</sub> dia.

Pre-wired Connector Models

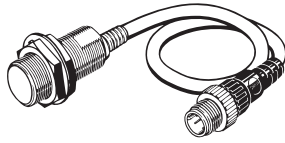

E2ER-X2D□-M1TGJ

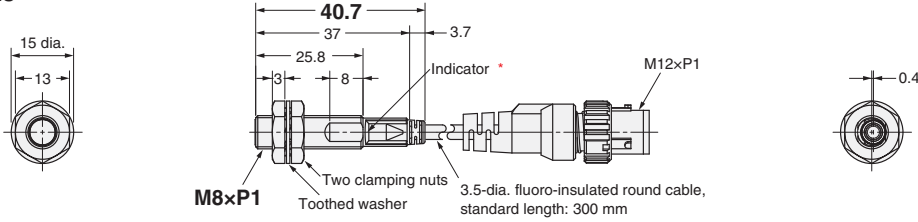

\* D1 Models: Operation indicator (red), Setting indicator (green),  
D2 Models: Operation indicator (red)

E2ER-X3D□-M1TGJ  
E2ERZ-X2D□-M1TGJ

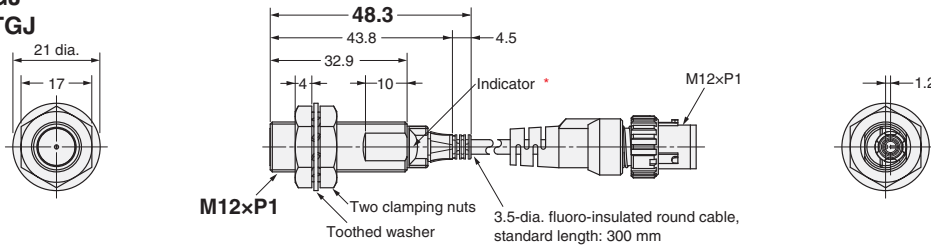

\* D1 Models: Operation indicator (red), Setting indicator (green),  
D2 Models: Operation indicator (red)

E2ER-X7D□-M1TGJ  
E2ERZ-X4D□-M1TGJ

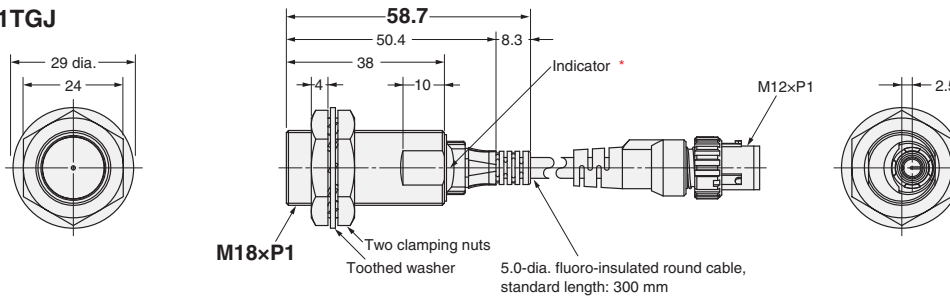

\* D1 Models: Operation indicator (red), Setting indicator (green),  
D2 Models: Operation indicator (red)

E2ER-X10D□-M1TGJ  
E2ERZ-X8D□-M1TGJ

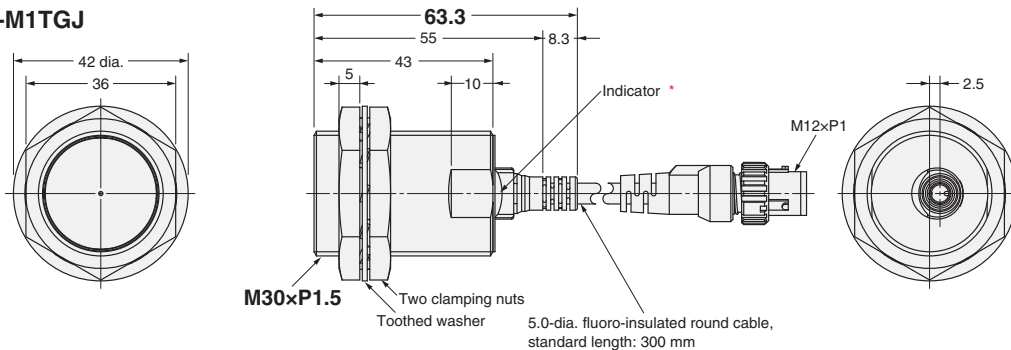

\* D1 Models: Operation indicator (red), Setting indicator (green),  
D2 Models: Operation indicator (red)

Mounting Hole Dimensions

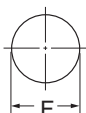

Dimension	M8	M12	M18	M30
F (mm)	8.5 <sup>+0.5</sup> <sub>0</sub> dia.	12.5 <sup>+0.5</sup> <sub>0</sub> dia.	18.5 <sup>+0.5</sup> <sub>0</sub> dia.	30.5 <sup>+0.5</sup> <sub>0</sub> dia.