

## Programmable Controllers Join the Series!

Program up to 256 segments and take advantage of the high cost performance of the new LCD that improves both the field of view and contrast.



48 x 48 mm  
E5CN-HT

For the most recent information on models that have been certified for safety standards, refer to your OMRON website.

- Set up to 8 programmed patterns with up to 32 segments (steps) each.
- High-resolution display with 5 digits/0.01°C display in a compact Controller (48 x 48 mm).
- High-speed sampling cycle of 60 ms.
- High Accuracy  
Thermocouple/Pt input:  $\pm 0.1\%$  of PV  
Analog input:  $\pm 0.1\%$  FS
- Universal inputs on all models (thermocouple, PT, or analog input) to handle various sensors with one Controller.
- A PV/SV-status display function can be set to automatically alternate between displaying the status of the Temperature Controller (auto/manual, RUN/RESET, and alarms) and the PV or SV.
- Flexible contact outputs with logic operations (AND, OR, and delays) set from the Support Software (CX-Thermo version 4.3). Program settings can be managed.
- Preventive maintenance for relays in the Temperature Controller using a Control Output ON/OFF Counter.

Refer to *Safety Precautions for E5□N/E5□N-H/ E5□N-HT*.

Refer to *Operation for E5□N/E5□N-H/ E5□N-HT* for operating procedures.

E53-CN□-500 in this catalog have been discontinued at the end of March 2018.

## Main I/O Functions

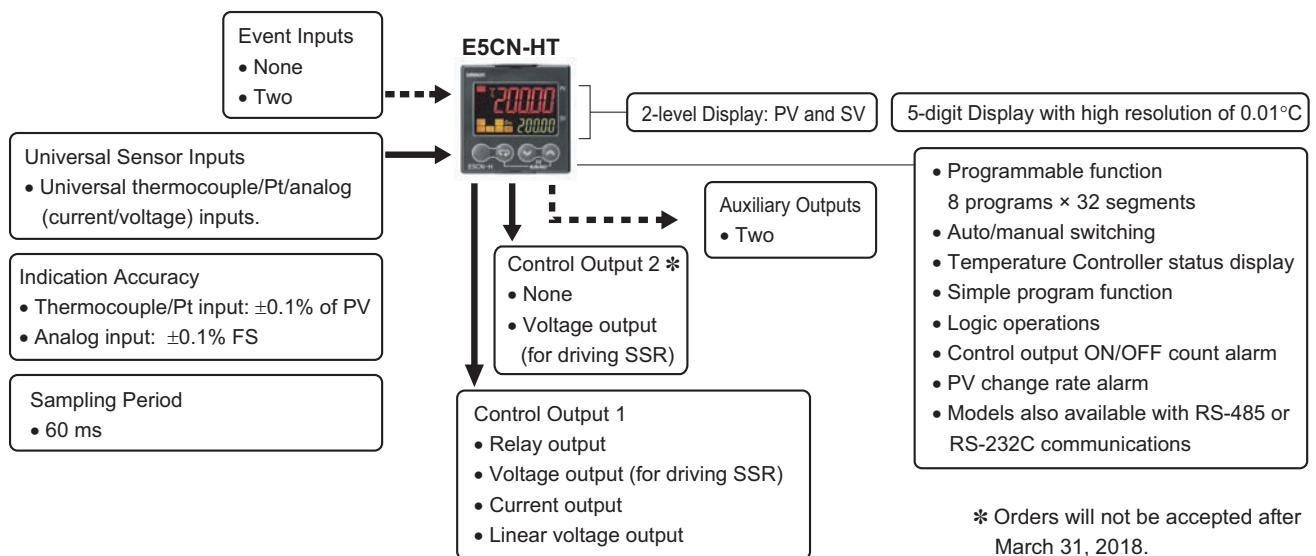

This data sheet is provided as a guideline for selecting products. Be sure to refer to the following user manuals for application precautions and other information required for operation before attempting to use the product.

E5CN-HT/E5AN-HT/E5EN-HT Digital Controllers User's Manual Programmable Type (Cat. No. H169)

E5CN-HT/E5AN-HT/E5EN-HT Digital Controllers Communications Manual Programmable Type (Cat. No. H170)

## Lineup

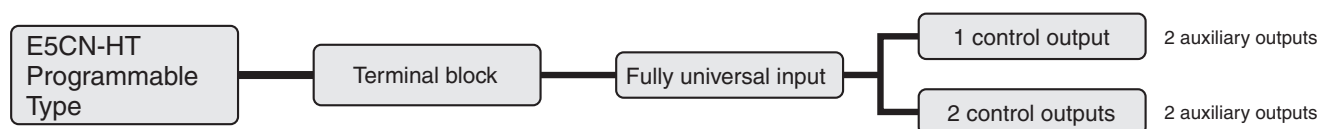

**Note:** Models with one control output and models with two control outputs can be used for heating/cooling control.

## Model Number Structure

### Model Number Legend

#### Controllers

E5CN-        M  -  -500

1 2 3 4 5 6 7

#### 1. Type

HT: Programmable

#### 2. Control Output 1

R: Relay output

Q: Voltage output (for driving SSR)

C: Current output

V: Linear voltage output

#### 3. Auxiliary Outputs

2: Two outputs

#### 4. Option 1

M: Option Unit can be mounted.

#### 5. Power Supply Voltage

Blank: 100 to 240 VAC

D: 24 VAC/VDC

#### 6. Case Color

Blank: Black

#### 7. Terminal Cover

-500: With terminal cover

#### Option Units

E53-        

1 2 3 4

#### 1. Applicable Controller

CN: E5CN-HT, E5CN-H or E5CN

#### 2. Function 1

Blank: None

Q: Control output 2 (voltage output for driving SSR) \*

P: Power supply for sensor

C: Current output

#### 3. Function 2

Blank: None

H: Heater burnout/SSR failure/Heater overcurrent detection (CT1)

HH: Heater burnout/SSR failure/Heater overcurrent detection

(CT2)

B: Two event inputs

03: RS-485 communications

H03: Heater burnout/SSR failure/Heater overcurrent detection

(CT1) + RS-485 communications

HB: Heater burnout/SSR failure/Heater overcurrent detection

(CT1) + Two event inputs

HH03: Heater burnout/SSR failure/Heater overcurrent detection

(CT2) + RS-485 communications

H01: Heater burnout/SSR failure/Heater overcurrent detection

(CT1)/RS-232C communications

F: Transfer output

BF: Two event inputs/Transfer output

#### 4. Version

N2: Available only to models released after January 2008

**Note: 1.** Not all combinations of function 1 and function 2 specifications are possible for Option Units (E53-        ).

**2.** Estimates can be provided for coatings and other specifications that are not given in the datasheet. Ask your OMRON representative for details.

\* Orders will not be accepted after March 31, 2018.

## Ordering Information

### Controllers

Size	Case Color	Power supply voltage	Auxiliary output	Control output 1	Model
1/16 DIN 48 × 48 × 78 (W × H × D)	Black	100 to 240 VAC	2	Relay output	E5CN-HTR2M-500
				Voltage output (for driving SSR)	E5CN-HTQ2M-500
				Current output	E5CN-HTC2M-500
		24 VAC/VDC	2	Linear voltage output	E5CN-HTV2M-500
				Relay output	E5CN-HTR2MD-500
				Voltage output (for driving SSR)	E5CN-HTQ2MD-500
		Current output	E5CN-HTC2MD-500		
		Linear voltage output	E5CN-HTV2MD-500		

### Option Units

One of the following Option Units can be mounted to provide the E5CN with additional functions.

Functions					Model
Communications RS-485		3-phase heater burnout/SSR failure/ Heater overcurrent detection			E53-CNHH03N2
		Heater burnout/SSR failure/ Heater overcurrent detection	Event inputs		E53-CNHBN2
Communications RS-485				Control output 2 (Voltage for driving SSR)	E53-CNQ03N2 *
Communications RS-485		Heater burnout/SSR failure/ Heater overcurrent detection			E53-CNH03N2
Communications RS-485					E53-CN03N2
			Event inputs		E53-CNBN2
		Heater burnout/SSR failure/ Heater overcurrent detection		Control output 2 (Voltage for driving SSR)	E53-CNQH02 *
		3-phase heater burnout/SSR failure/ Heater overcurrent detection		Control output 2 (Voltage for driving SSR)	E53-CNQH02 *
			Event inputs	Control output 2 (Voltage for driving SSR)	E53-CNQB02 *
				Control output 2 (Voltage for driving SSR)	E53-CNQF02 *
			Event inputs	Transfer Output	E53-CNBF02 *
	Communications RS-232C			Control output 2 (Voltage for driving SSR)	E53-CNQ01N2 *
	Communications RS-232C				E53-CN01N2
	Communications RS-232C	Heater burnout/SSR failure/ Heater overcurrent detection			E53-CNH01N2

**Note:** These Option Units are applicable only to models released after January 2008.

\* Orders will not be accepted after March 31, 2018.

### Accessories (Order Separately)

#### USB-Serial Conversion Cable

Model
E58-CIFQ1

#### Terminal Cover

Model
E53-COV17

**Note:** 1. The Terminal Cover comes with the E5CN-□□□-500 models.

2. The E53-COV10 cannot be used.

#### Waterproof Packing

Model
Y92S-P8

**Note:** Waterproof Packing is included with the controller only for models with terminal blocks.

#### Current Transformers (CTs)

Hole diameter	Model
5.8 dia.	E54-CT1
12.0 dia.	E54-CT3

#### Adapter

Connectable models	Model
Terminal type	Y92F-45

**Note:** Use this Adapter when the panel has been previously prepared for the E5B□.

#### DIN Track Mounting Adapter

Model
Y92F-52

#### Front cover

Type	Model
Hard Front Cover	Y92A-48B
Soft Front Cover	Y92A-48D

#### CX-Thermo Support Software

Model
EST2-2C-MV4

#### Mounting Adapter

Model
Y92F-49

**Note:** This Mounting Adapter is provided with the Digital Temperature Controller.

## Specifications

### Ratings

<b>Power supply voltage</b>	No D in model number: 100 to 240 VAC, 50/60 Hz D in model number: 24 VAC, 50/60 Hz; 24 VDC	
<b>Operating voltage range</b>	85% to 110% of rated supply voltage	
<b>Power consumption</b>	100 to 240 VAC: 8.5 VA (max.) (E5CN-HTR2 at 100 VAC: 3.0 VA) 24 VAC/VDC: 5.5 VA (24 VAC)/3.5 W (24 VDC) (max.) (E5CN-HTR2D at 24 VAC: 2.7 VA)	
<b>Sensor input</b>	Any of the following can be selected (i.e., fully universal input). Thermocouple: K, J, T, E, L, U, N, R, S, B, W, or PL II Platinum resistance thermometer: Pt100 or JPt100 Current input: 4 to 20 mA or 0 to 20 mA Voltage input: 1 to 5 V, 0 to 5 V, or 0 to 10 V	
<b>Input impedance</b>	Current input: 150 Ω max., Voltage input: 1 MΩ min. (Use a 1:1 connection when connecting the ES2-HB-N.)	
<b>Control method</b>	ON/OFF control or 2-PID control (with auto-tuning)	
<b>Control output</b>	<b>Relay output</b>	SPST-NO, 250 VAC, 3 A (resistive load), electrical life: 100,000 operations, minimum applicable load: 5 V, 10 mA
	<b>Current output</b>	4 to 20 mA DC/0 to 20 mA DC, load: 600 Ω max., resolution: approx. 10,000 *
	<b>Linear voltage output</b>	0 to 10 VDC (load: 1 kΩ min.), Resolution: Approx. 10,000
<b>Auxiliary output</b>	<b>Number of outputs</b>	2 max.
	<b>Output specifications</b>	Relay output: SPST-NO, 250 VAC, 3 A (resistive load), electrical life: 100,000 operations, minimum applicable load: 5 V, 10 mA
<b>Event input</b>	<b>Number of outputs</b>	2
	<b>External contact input specifications</b>	Contact input: ON: 1 kΩ max., OFF: 100 kΩ min.
		Non-contact input: ON: Residual voltage: 1.5 V max., OFF: Leakage current: 0.1 mA max.
Current flow: Approx. 7 mA per contact		
<b>Logic operations</b>	<b>Number of operations</b>	8 max. (Combinations can be made using work bits.)
	<b>Operations</b>	<ul style="list-style-type: none"> <li>Logic operation: Any of the following four patterns can be selected. The input status may be inverted. (A and B) or (C and D), (A or C) and (B or D), A or B or C or D, A and B and C and D (A, B, C, and D are four inputs.)</li> <li>Delay: ON delay or OFF delay for the results of the logic operation given above. Setting time: 0 to 9999 s or 0 to 9999 min</li> <li>Output inversion: Possible</li> </ul>
		<b>Outputs</b>
	<b>Work bit assignments</b>	Any of the following can be assigned to up to eight work bits (logic operation results): Operation commands (assigned to event inputs) *, auxiliary outputs, or control outputs. * Application is possible with models that do not have event inputs by using an internal assignment.
<b>Transfer outputs</b>	<b>Number of outputs</b>	1 max.
	<b>Output specifications</b>	Current output: 4 to 20 mA DC, Load: 600 Ω max., Resolution at 4 to 20 mA: Approx. 10,000
<b>RSP input</b>	Not supported	
<b>Setting method</b>	Digital setting using front panel keys	
<b>Indication method</b>	11-segment digital display and individual indicators (7-segments displays also possible) Character height: PV: 11 mm, SV: 6.5 mm	
<b>Other functions</b>	Manual output, heating/cooling control, loop burnout alarm, other alarm functions, heater burnout detection (including SSR failure and heater overcurrent detection), 40% AT, 100% AT, MV limiter, input digital filter, temperature input shift, run/reset, protection functions, control output ON/OFF counter, extraction of square root, MV change rate limit, PV/SV status display, automatic cooling coefficient adjustment, program control functions, etc.	
<b>Ambient operating temperature</b>	-10 to 55°C (with no condensation or icing), for 3-year warranty: -10 to 50°C	
<b>Ambient operating humidity</b>	25% to 85%	
<b>Storage temperature</b>	-25 to 65°C (with no condensation or icing)	

\* For models with current outputs, control output 1 can be used as a transfer output.



## Alarm Outputs

Each alarm can be independently set to one of the following 13 alarm types. The default is 2: *Upper limit*. Auxiliary outputs are allocated for alarms. ON delays and OFF delays (0 to 999 s) can also be specified.

**Note:** For models with heater burnout, SSR failure, and heater overcurrent detection, alarm 1 will be an OR output of the alarm selected from the following alarm types and the alarms for heater burnout, SSR failure, and heater overcurrent. To output only a heater burnout alarm, SSR failure alarm, and heater overcurrent alarm for alarm 1, set the alarm type to 0 (i.e., no alarm function).

Set value	Alarm type	Alarm output operation		Description of function
		When alarm value X is positive	When alarm value X is negative	
0	Alarm function OFF	Output OFF		No alarm
1 *1	Upper- and lower-limit	ON OFF	*2	Set the deviation in the set point by setting the alarm upper limit (H) and alarm lower limit (L).
2	Upper-limit	ON OFF	ON OFF	Set the upward deviation in the set point by setting the alarm value (X).
3	Lower-limit	ON OFF	ON OFF	Set the downward deviation in the set point by setting the alarm value (X).
4 *1	Upper- and lower-limit range	ON OFF	*3	Set the deviation in the set point by setting the alarm upper limit (H) and alarm lower limit (L).
5 *1	Upper- and lower-limit with standby sequence	ON OFF	*4	A standby sequence is added to the upper- and lower-limit alarm (1). *6
6	Upper-limit with standby sequence	ON OFF	ON OFF	A standby sequence is added to the upper-limit alarm (2). *6
7	Lower-limit with standby sequence	ON OFF	ON OFF	A standby sequence is added to the lower-limit alarm (3). *6
8	Absolute-value upper-limit	ON OFF	ON OFF	The alarm will turn ON if the process value is larger than the alarm value (X) regardless of the set point.
9	Absolute-value lower-limit	ON OFF	ON OFF	The alarm will turn ON if the process value is smaller than the alarm value (X) regardless of the set point.
10	Absolute-value upper-limit with standby sequence	ON OFF	ON OFF	A standby sequence is added to the absolute-value upper-limit alarm (8). *6
11	Absolute-value lower-limit with standby sequence	ON OFF	ON OFF	A standby sequence is added to the absolute-value lower-limit alarm (9). *6
12	LBA (alarm 1 type only)	---		*7
13	PV change rate alarm	---		*8

\*1. With set values 1, 4 and 5, the upper and lower limit values can be set independently for each alarm type, and are expressed as "L" and "H."

\*2. Set value: 1, Upper- and lower-limit alarm

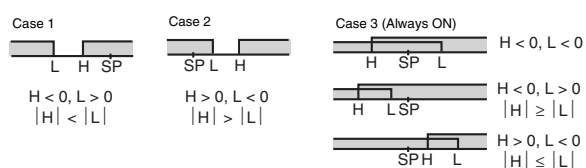

\*3. Set value: 4, Upper- and lower-limit range

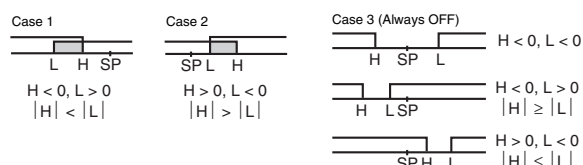

\*4. Set value: 5, Upper- and lower-limit with standby sequence  
For Upper- and Lower-Limit Alarm Described Above

- Case 1 and 2  
Always OFF when the upper-limit and lower-limit hysteresis overlaps.
- Case 3: Always OFF

\*5. Set value: 5, Upper- and lower-limit with standby sequence  
Always OFF when the upper-limit and lower-limit hysteresis overlaps.

\*6. Refer to the *E5CN-HT/E5AN-HT/E5EN-HT Digital Controllers User's Manual* (Cat. No. H169) for information on the operation of the standby sequence.

\*7. Refer to the *E5CN-HT/E5AN-HT/E5EN-HT Digital Controllers User's Manual* (Cat. No. H169) for information on the loop burnout alarm (LBA).

\*8. Refer to the *E5CN-HT/E5AN-HT/E5EN-HT Digital Controllers User's Manual* (Cat. No. H169) for information on the PV change rate alarm.

## Characteristics

<b>Indication accuracy</b>	Thermocouple: ( $\pm 0.1\%$ of indicated value or $\pm 1^\circ\text{C}$ , whichever is greater) $\pm 1$ digit max. *1 Platinum resistance thermometer: ( $\pm 0.1\%$ of indicated value or $\pm 0.5^\circ\text{C}$ , whichever is greater) $\pm 1$ digit max. Analog input: $\pm 0.1\%$ FS $\pm 1$ digit max. CT input: $\pm 5\%$ FS $\pm 1$ digit max.	
<b>Transfer output accuracy</b>	$\pm 0.3\%$ FS max.	
<b>Influence of temperature *2</b>	Thermocouple input (R, S, B, W, PLII): ( $\pm 1\%$ of PV or $\pm 10^\circ\text{C}$ , whichever is greater) $\pm 1$ digit max.	
<b>Influence of voltage *2</b>	Other thermocouple input: ( $\pm 1\%$ of PV or $\pm 4^\circ\text{C}$ , whichever is greater) $\pm 1$ digit max. *3	
<b>Influence of EMS. (at EN 61326-1)</b>	Platinum resistance thermometer: ( $\pm 1\%$ of PV or $\pm 2^\circ\text{C}$ , whichever is greater) $\pm 1$ digit max. Analog input: ( $\pm 1\%$ FS) $\pm 1$ digit max.	
<b>Input sampling period</b>	60 ms	
<b>Hysteresis</b>	Temperature input: 0.1 to 3240.0°C or °F (in units of 0.1°C or °F) Analog input: 0.01% to 99.99% FS (in units of 0.01% FS)	
<b>Proportional band (P)</b>	Temperature input: 0.1 to 3240.0°C or °F (in units of 0.1 °C or °F) Analog input: 0.1% to 999.9% FS (in units of 0.1% FS)	
<b>Integral time (I)</b>	0.0 to 3240.0 s (in units of 0.1 s)	
<b>Derivative time (D)</b>	0.0 to 3240.0 s (in units of 0.1 s)	
<b>Control period</b>	0.5, 1 to 99 s (in units of 1 s)	
<b>Manual reset value</b>	0.0 to 100.0% (in units of 0.1%)	
<b>Alarm setting range</b>	-19999 to 32400 (decimal point position depends on input type)	
<b>Affect of signal source resistance</b>	Thermocouple: 0.1°C/Ω max. (100 Ω max.) Platinum resistance thermometer: 0.1°C/Ω max. (10 Ω max.)	
<b>Insulation resistance</b>	20 MΩ min. (at 500 VDC)	
<b>Dielectric strength</b>	2,300 VAC, 50 or 60 Hz for 1 min (between terminals with different charge)	
<b>Vibration resistance</b>	<b>Malfunction</b>	10 to 55 Hz, 20 m/s <sup>2</sup> for 10 min each in X, Y, and Z directions
	<b>Destruction</b>	10 to 55 Hz, 0.75-mm single amplitude for 2 hrs each in X, Y, and Z directions
<b>Shock resistance</b>	<b>Malfunction</b>	100 m/s <sup>2</sup> , 3 times each in X, Y, and Z directions
	<b>Destruction</b>	300 m/s <sup>2</sup> , 3 times each in X, Y, and Z directions
<b>Weight</b>	Controller: Approx. 150 g, Mounting Bracket: Approx. 10 g	
<b>Degree of protection</b>	Front panel: IP66, Rear case: IP20, Terminals: IP00	
<b>Memory protection</b>	Non-volatile memory (number of writes: 1,000,000 times)	
<b>Setup Tool</b>	CX-Thermo version 4.3 or higher	
<b>Setup Tool port</b>	Provided on the bottom of the E5CN-HT. Use this port to connect a computer to the E5CN-HT. An E58-CIFQ1 USB-Serial Conversion Cable is required to connect the computer to the E5CN-HT. *4	
<b>Standards</b>	<b>Approved standards</b>	UL 61010-1, CSA C22.2 No. 1010-1
	<b>Conformed standards</b>	EN 61010-1 (IEC 61010-1): Pollution level 2, overcurrent category II
<b>EMC</b>	EMI: Radiated Interference Electromagnetic Field Strength: Noise Terminal Voltage: EMS: ESD Immunity: Electromagnetic Field Immunity: Burst Noise Immunity: Conducted Disturbance Immunity: Surge Immunity: Power Frequency Magnetic Field Immunity: Voltage Dip/Interrupting Immunity:	EN 61326-1 *5 EN 55011 Group 1, class A EN 55011 Group 1, class A EN 61326-1 *5 EN 61000-4-2 EN 61000-4-3 EN 61000-4-4 EN 61000-4-6 EN 61000-4-5 EN 61000-4-8 EN 61000-4-11

\*1. The indication accuracy of K thermocouples in the  $-200$  to  $1300^\circ\text{C}$  range, T and N thermocouples at a temperature of  $-100^\circ\text{C}$  max., and U and L thermocouples at any temperatures is  $\pm 2^\circ\text{C} \pm 1$  digit max. The indication accuracy of the B thermocouple at a temperature of  $400^\circ\text{C}$  max. is not specified. The indication accuracy of B thermocouples in the  $400$  to  $800^\circ\text{C}$  range is  $\pm 3^\circ\text{C}$  max. The indication accuracy of the R and S thermocouples at a temperature of  $200^\circ\text{C}$  max. is  $\pm 3^\circ\text{C} \pm 1$  digit max. The indication accuracy of W thermocouples is  $\pm 0.3$  of PV or  $\pm 3^\circ\text{C}$ , whichever is greater,  $\pm 1$  digit max. The indication accuracy of PL II thermocouples is  $\pm 0.3$  of PV or  $\pm 2^\circ\text{C}$ , whichever is greater,  $\pm 1$  digit max.

\*2. Ambient temperature:  $-10^\circ\text{C}$  to  $23^\circ\text{C}$  to  $55^\circ\text{C}$ , Voltage range:  $-15\%$  to  $10\%$  of rated voltage

\*3. K thermocouple at  $-100^\circ\text{C}$  max.:  $\pm 10^\circ\text{C}$  max.

\*4. External communications (RS-232C or RS-485) and cable communications for the Setup Tool can be used at the same time.

\*5. Industrial electromagnetic environment (EN/IEC 61326-1 Table 2)

## Program Control

<b>Number of programs (patterns)</b>	8	
<b>Number of segments (steps)</b>	32	
<b>Segment setting method</b>	Time setting (Segment set with set point and time.)	
	Gradient setting (Segment type with set point, gradient, and time.)	
<b>Segment times</b>	0 h 0 min to 99 h 59 min	
	0 min 0 s to 99 min 59 s	
<b>Alarm setting</b>	Set separately for each program.	
<b>Reset operation</b>	Select either stopping control or fixed SP operation.	
<b>Startup operation</b>	Select continuing, resetting, manual operation, or run mode.	
<b>PID sets</b>	Number of sets	8
	Setting method	Set separately for each program (automatic PID group selection also supported).
<b>Alarm SP function</b>	Select from ramp SP and target SP.	
<b>Program status control</b>	Segment operation	Advance, hold
	Program operation	Program repetitions and program links
<b>Wait operation</b>	Wait method	Waiting at segment ends
	Wait width setting	Same wait width setting for all programs
<b>Time signals</b>	Number of outputs	2
	Number of ON/OFF Operations	1 each per output
	Setting method	Set separately for each program.
<b>Program status output</b>	Program end output (pulse width can be set), run output, stage output	
<b>Program startup operation</b>	PV start	Select from segment 1 set point, slope-priority PV start
	Standby	0 h 0 min to 99 h 59 min
		0 day 0 h to 99 day 23h
<b>Operation end operation</b>	Select from resetting, continuing control at final set point, and fixed SP control.	
<b>Program SP shift</b>	Same program SP shift for all programs	



## USB-Serial Conversion Cable

Applicable OS	Windows XP/Vista/7/8/8.1/10
Applicable software	CX-Thermo version 4 or higher
Applicable models	E5AN/E5EN/E5CN/E5CN-U/ E5AN-H/E5EN-H/E5CN-H/E5AN- HT/E5EN-HT/E5CN-HT
USB interface standard	Conforms to USB Specification 1.1.
DTE speed	38400 bps
Connector specifications	Computer: USB (type A plug) Temperature Controller: Setup Tool port (on bottom of Controller)
Power supply	Bus power (Supplied from USB host controller.)
Power supply voltage	5 VDC
Current consumption	70 mA
Ambient operating temperature	0 to 55°C (with no condensation or icing)
Ambient operating humidity	10% to 80%
Storage temperature	-20 to 60°C (with no condensation or icing)
Storage humidity	10% to 80%
Altitude	2,000 m max.
Weight	Approx. 100 g

**Note:** A driver must be installed in the personal computer. Refer to installation information in the operation manual for the Conversion Cable.

## Communications Specifications

Transmission line connection method	RS-485: Multipoint RS-232C: Point-to-point
Communications	RS-485 (two-wire, half duplex)/RS-232C
Synchronization method	Start-stop synchronization
Protocol	CompoWay/F or Modbus
Baud rate	1200, 2400, 4800, 9600, 19200, 38400, or 57600 bps
Transmission code	ASCII (CompoWay/F, SYSWAY) RTU (Modbus)
Data bit length *	7 or 8 bits
Stop bit length *	1 or 2 bits
Error detection	Vertical parity (none, even, odd) Block check character (BCC) with CompoWay/F or CRC-16 Modbus
Flow control	None
Interface	RS-485, RS-232C
Retry function	None
Communications buffer	217 bytes
Communications response wait time	0 to 99 ms Default: 20 ms

\* The baud rate, data bit length, stop bit length, and vertical parity can be individually set using the Communications Setting Level.

## Current Transformer (Order Separately) Ratings

Dielectric strength	1,000 VAC for 1 min
Vibration resistance	50 Hz, 98 m/s <sup>2</sup>
Weight	E54-CT1: Approx. 11.5 g, E54-CT3: Approx. 50 g
Accessories (E54-CT3 only)	Armatures (2) Plugs (2)

## Heater Burnout Alarms, SSR Failure Alarms, and Heater Overcurrent Alarms

CT input (for heater current detection)	Models with detection for single-phase heaters: One input Models with detection for single-phase or three-phase heaters: Two inputs
Maximum heater current	50 A AC
Input current indication accuracy	±5% FS ±1 digit max.
Heater burnout alarm setting range *1	0.1 to 49.9 A (in units of 0.1 A) Minimum detection ON time: 100 ms
SSR failure alarm setting range *2	0.1 to 49.9 A (in units of 0.1 A) Minimum detection OFF time: 100 ms
Heater overcurrent alarm setting range *3	0.1 to 49.9 A (in units of 0.1 A) Minimum detection ON time: 100 ms

- \*1. For heater burnout alarms, the heater current will be measured when the control output is ON, and the output assigned to the alarm 1 function will turn ON if the heater current is lower than the set value (i.e., heater burnout detection current value).
- \*2. For SSR failure alarms, the heater current will be measured when the control output is OFF, and the output assigned to the alarm 1 function will turn ON if the heater current is higher than the set value (i.e., SSR failure detection current value).
- \*3. For heater overcurrent alarms, the heater current will be measured when the control output is ON, and the output assigned to the alarm 1 function will turn ON if the heater current is higher than the set value (i.e., heater overcurrent detection current value).

## Electrical Life Expectancy Curve for Relays (Reference Values)

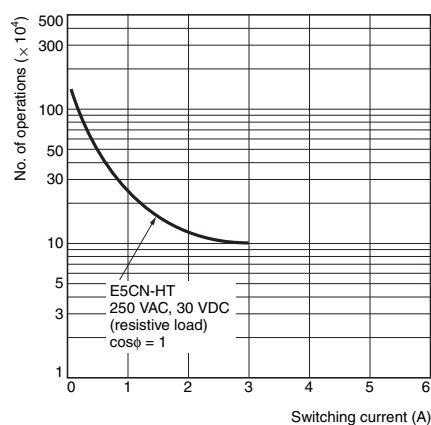

## External Connections

- A voltage output (control output, for driving SSR) is not electrically insulated from the internal circuits. When using a grounding thermocouple, do not connect any of the control output terminals to ground. If the control output terminals are connected to ground, errors will occur in the measured temperature values as a result of leakage current.

### Controllers

**Control output 1**

Relay output  
250 VAC, 3 A  
(resistive load)

Voltage output  
(for driving SSR)  
12 VDC, 21 mA

Linear voltage output  
0 to 10 VDC  
Load 1 kΩ min.

Current output  
0 to 20 mA DC  
4 to 20 mA DC  
Load 600 Ω max.

The Temperature Controller is set for a K-type thermocouple (input type = 5) by default. An input error (5.ERR) will occur if the input type setting does not agree with the temperature sensor. Check the input type.

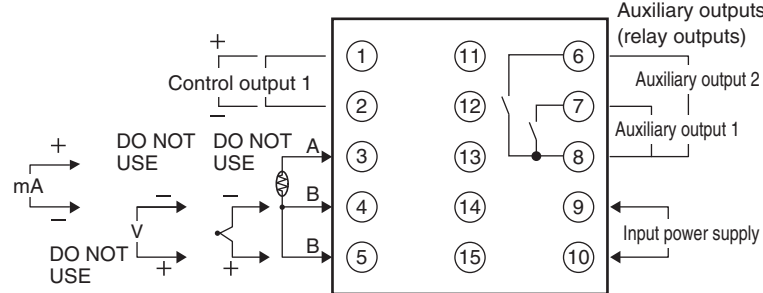

**Auxiliary outputs (relay outputs)**  
250 VAC, 3 A  
(resistive load)

A heater burnout alarm, SSR failure, heater overcurrent alarm, or input alarm is sent to the output to which the alarm 1 function is assigned.

- 100 to 240 VAC
- 24 VAC/VDC (no polarity)

### Option Units

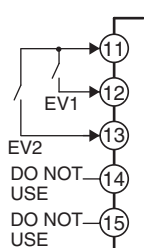
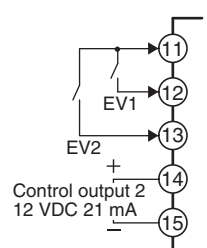
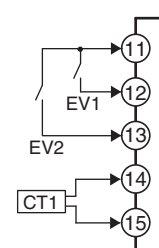
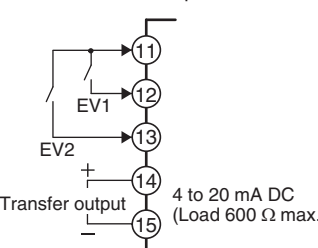
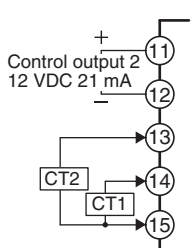
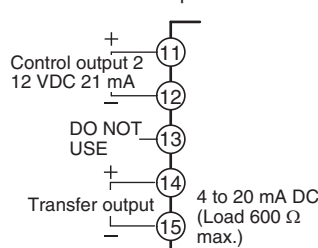
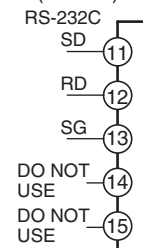
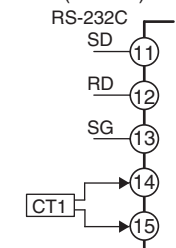
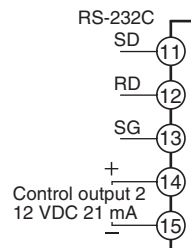
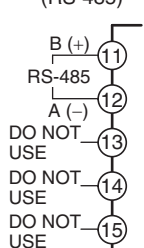
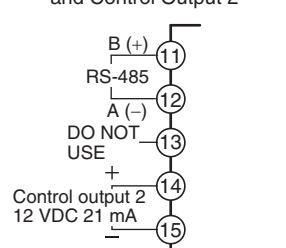
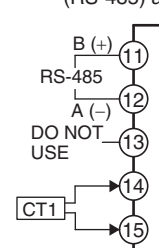
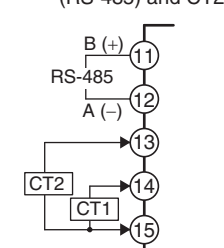
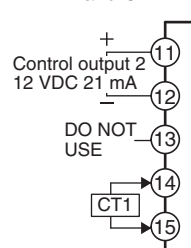
<p>E53-CNBN2 Event Inputs</p> 	<p>E53-CNQBN2 * Event Inputs and Control Output 2</p> 	<p>E53-CNHBN2 Event Inputs and CT</p> 	<p>E53-CNBFN2 Event Inputs and Transfer Output</p> 	
<p>E53-CNQHNN2 * Control Output 2 and CT2</p> 	<p>E53-CNQFN2 * Control Output 2 and Transfer Output</p> 	<p>E53-CN01N2 Communications (RS-232C)</p> 	<p>E53-CNH01N2 Communications (RS-232C) and CT</p> 	<p>E53-CNQ01N2 * Communications (RS-232C) and Control Output 2</p> 
<p>E53-CN03N2 Communications (RS-485)</p> 	<p>E53-CNQ03N2 * Communications (RS-485) and Control Output 2</p> 	<p>E53-CNH03N2 Communications (RS-485) and CT</p> 	<p>E53-CNHH03N2 Communications (RS-485) and CT2</p> 	<p>E53-CNQHNN2 * Control Output 2 and CT</p> 

**Note:** Wire all voltage input terminals correctly. The Controller may fail if voltage input terminals are wired incorrectly.  
 \* Orders will not be accepted after March 31, 2018.

## Isolation/Insulation Block Diagrams

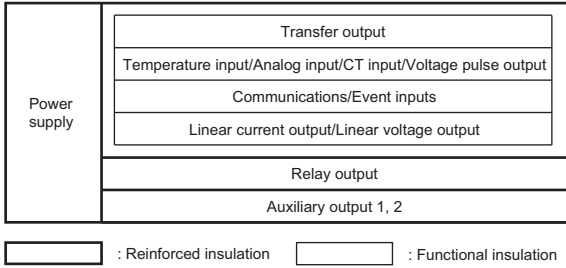

## Nomenclature

### E5CN-HT

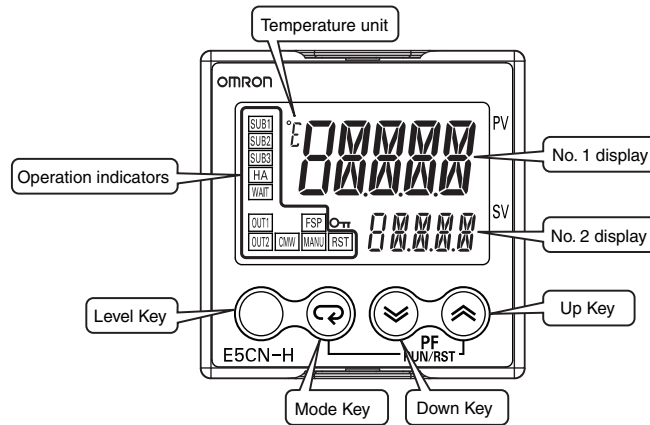

## Dimensions

(Unit: mm)

### E5CN-HT

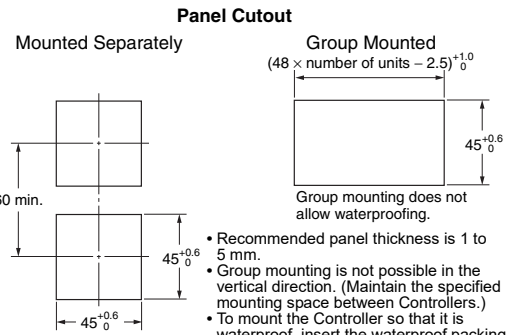
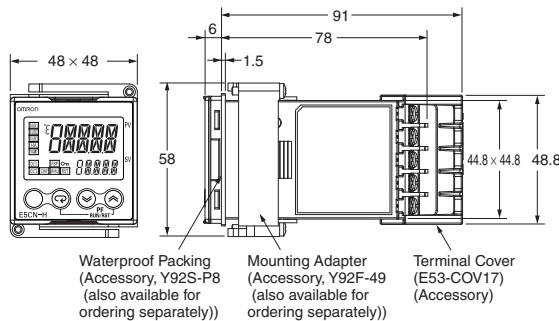

- Recommended panel thickness is 1 to 5 mm.
- Group mounting is not possible in the vertical direction. (Maintain the specified mounting space between Controllers.)
- To mount the Controller so that it is waterproof, insert the waterproof packing onto the Controller.
- When two or more Controllers are mounted, make sure that the surrounding temperature does not exceed the allowable operating temperature specified in the specifications.

**Note:** The terminal block cannot be removed.

## Accessories (Order Separately)

### USB-Serial Conversion Cable

#### E58-CIFQ1

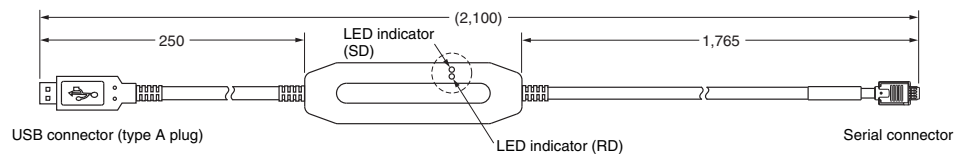
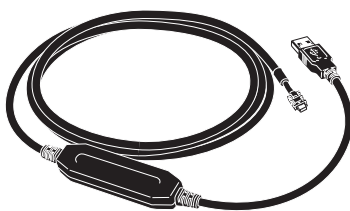

**Terminal Cover**  
E53-COV17

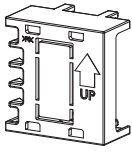

**Note:** The E53-COV10 can not be used.

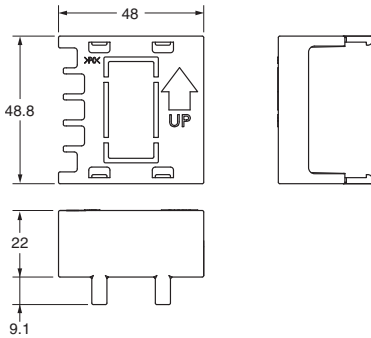

**Waterproof Packing**  
Y92S-P8 (for DIN 48 × 48)

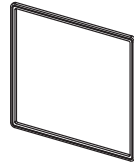

Order the Waterproof Packing separately if it becomes lost or damaged.  
The Waterproof Packing can be used to achieve an IP66 degree of protection.  
(Deterioration, shrinking, or hardening of the waterproof packing may occur depending on the operating environment. Therefore, periodic replacement is recommended to ensure the level of waterproofing specified in IP66. The time for periodic replacement depends on the operating environment. Be sure to confirm this point at your site. Consider one year a rough standard. OMRON shall not be liable for the level of water resistance if the customer does not perform periodic replacement.)  
The Waterproof Packing does not need to be attached if a waterproof structure is not required.

**Current Transformers**

**E54-CT1**

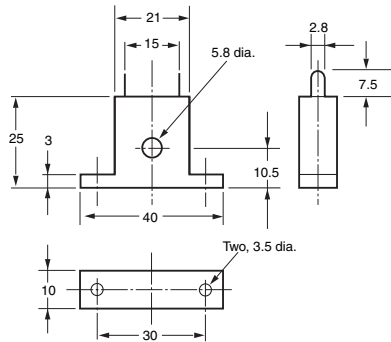
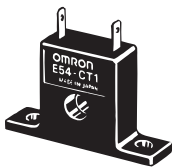

**E54-CT1**

**Thru-current (Io) vs. Output Voltage (Eo) (Reference Values)**

Maximum continuous heater current: 50 A (50/60 Hz)  
Number of windings: 400±2  
Winding resistance: 18±2 Ω

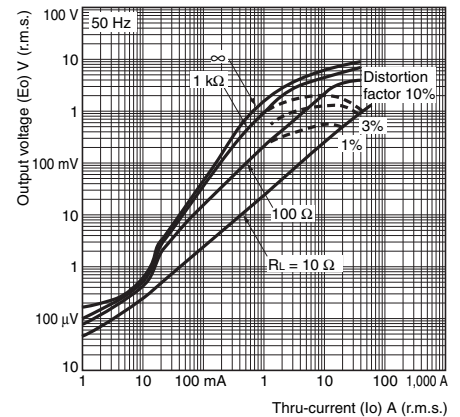

**E54-CT3**

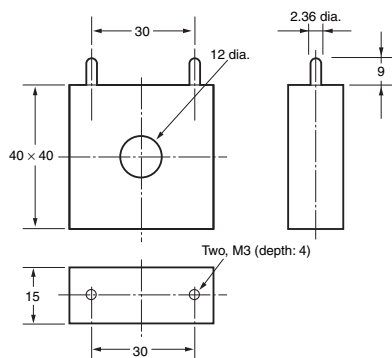

**E54-CT3**

**Thru-current (Io) vs. Output Voltage (Eo) (Reference Values)**

Maximum continuous heater current: 120 A (50/60 Hz)  
(Maximum continuous heater current for an OMRON Temperature Controller is 50 A.)  
Number of windings: 400±2  
Winding resistance: 8±0.8 Ω

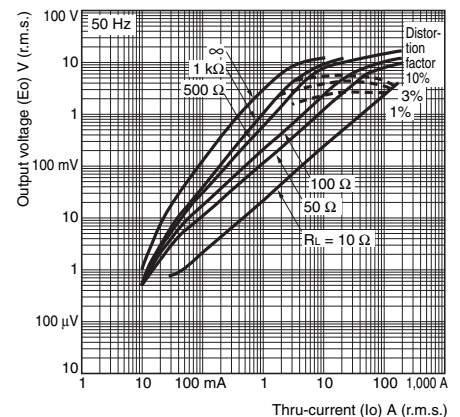

**E54-CT3 Accessory**

• **Armature**

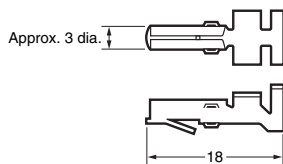

• **Plug**

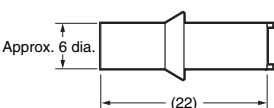

**Connection Example**

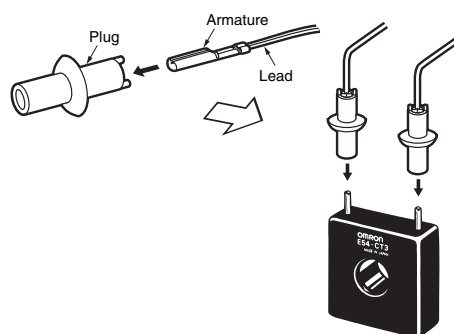

**Adapter**

**Y92F-45** Note: 1. Use this Adapter when the panel has already been prepared for the E5B□.  
 2. The Adapter is available only in black.

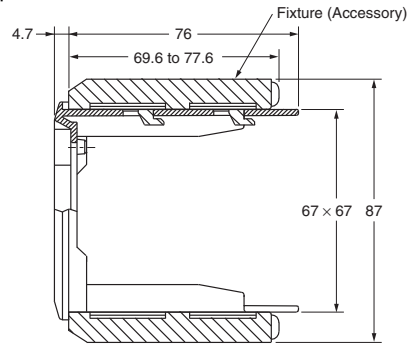
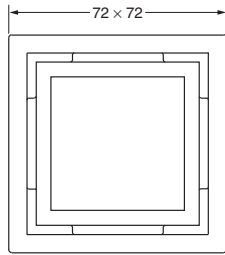
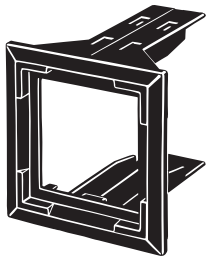

**Mounted to E5CN-HT**

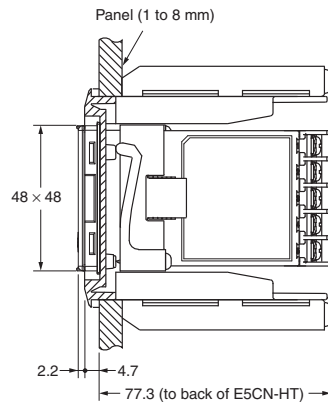
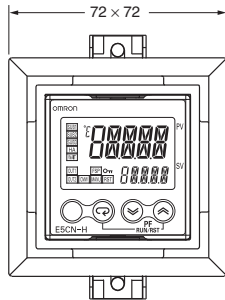
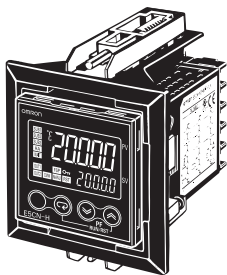

**DIN Track Mounting Adapter**

**Y92F-52** Note: This Adapter cannot be used together with the Terminal Cover.  
 Remove the Terminal Cover to use the Adapter.

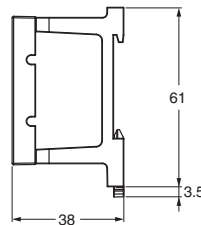
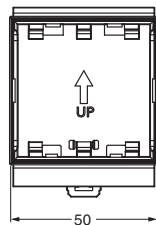
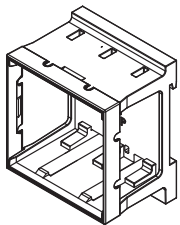

**Mounted to E5CN-HT**

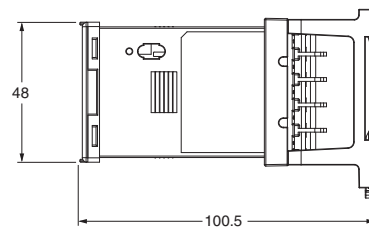
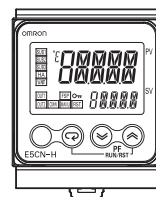

## Terms and Conditions Agreement

### Read and understand this catalog.

Please read and understand this catalog before purchasing the products. Please consult your OMRON representative if you have any questions or comments.

### Warranties.

(a) Exclusive Warranty. Omron's exclusive warranty is that the Products will be free from defects in materials and workmanship for a period of twelve months from the date of sale by Omron (or such other period expressed in writing by Omron). Omron disclaims all other warranties, express or implied.

(b) Limitations. OMRON MAKES NO WARRANTY OR REPRESENTATION, EXPRESS OR IMPLIED, ABOUT NON-INFRINGEMENT, MERCHANTABILITY OR FITNESS FOR A PARTICULAR PURPOSE OF THE PRODUCTS. BUYER ACKNOWLEDGES THAT IT ALONE HAS DETERMINED THAT THE PRODUCTS WILL SUITABLY MEET THE REQUIREMENTS OF THEIR INTENDED USE.

Omron further disclaims all warranties and responsibility of any type for claims or expenses based on infringement by the Products or otherwise of any intellectual property right. (c) Buyer Remedy. Omron's sole obligation hereunder shall be, at Omron's election, to (i) replace (in the form originally shipped with Buyer responsible for labor charges for removal or replacement thereof) the non-complying Product, (ii) repair the non-complying Product, or (iii) repay or credit Buyer an amount equal to the purchase price of the non-complying Product; provided that in no event shall Omron be responsible for warranty, repair, indemnity or any other claims or expenses regarding the Products unless Omron's analysis confirms that the Products were properly handled, stored, installed and maintained and not subject to contamination, abuse, misuse or inappropriate modification. Return of any Products by Buyer must be approved in writing by Omron before shipment. Omron Companies shall not be liable for the suitability or unsuitability or the results from the use of Products in combination with any electrical or electronic components, circuits, system assemblies or any other materials or substances or environments. Any advice, recommendations or information given orally or in writing, are not to be construed as an amendment or addition to the above warranty.

See <http://www.omron.com/global/> or contact your Omron representative for published information.

### Limitation on Liability: Etc.

OMRON COMPANIES SHALL NOT BE LIABLE FOR SPECIAL, INDIRECT, INCIDENTAL, OR CONSEQUENTIAL DAMAGES, LOSS OF PROFITS OR PRODUCTION OR COMMERCIAL LOSS IN ANY WAY CONNECTED WITH THE PRODUCTS, WHETHER SUCH CLAIM IS BASED IN CONTRACT, WARRANTY, NEGLIGENCE OR STRICT LIABILITY.

Further, in no event shall liability of Omron Companies exceed the individual price of the Product on which liability is asserted.

### Suitability of Use.

Omron Companies shall not be responsible for conformity with any standards, codes or regulations which apply to the combination of the Product in the Buyer's application or use of the Product. At Buyer's request, Omron will provide applicable third party certification documents identifying ratings and limitations of use which apply to the Product. This information by itself is not sufficient for a complete determination of the suitability of the Product in combination with the end product, machine, system, or other application or use. Buyer shall be solely responsible for determining appropriateness of the particular Product with respect to Buyer's application, product or system. Buyer shall take application responsibility in all cases.

NEVER USE THE PRODUCT FOR AN APPLICATION INVOLVING SERIOUS RISK TO LIFE OR PROPERTY OR IN LARGE QUANTITIES WITHOUT ENSURING THAT THE SYSTEM AS A WHOLE HAS BEEN DESIGNED TO ADDRESS THE RISKS, AND THAT THE OMRON PRODUCT(S) IS PROPERLY RATED AND INSTALLED FOR THE INTENDED USE WITHIN THE OVERALL EQUIPMENT OR SYSTEM.

### Programmable Products.

Omron Companies shall not be responsible for the user's programming of a programmable Product, or any consequence thereof.

### Performance Data.

Data presented in Omron Company websites, catalogs and other materials is provided as a guide for the user in determining suitability and does not constitute a warranty. It may represent the result of Omron's test conditions, and the user must correlate it to actual application requirements. Actual performance is subject to the Omron's Warranty and Limitations of Liability.

### Change in Specifications.

Product specifications and accessories may be changed at any time based on improvements and other reasons. It is our practice to change part numbers when published ratings or features are changed, or when significant construction changes are made. However, some specifications of the Product may be changed without any notice. When in doubt, special part numbers may be assigned to fix or establish key specifications for your application. Please consult with your Omron's representative at any time to confirm actual specifications of purchased Product.

### Errors and Omissions.

Information presented by Omron Companies has been checked and is believed to be accurate; however, no responsibility is assumed for clerical, typographical or proofreading errors or omissions.