

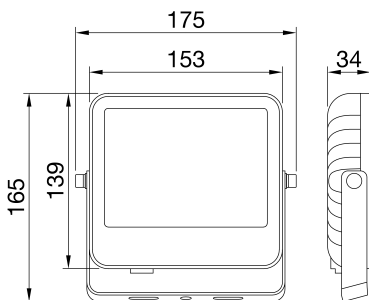

ELIA FL Mini is a low-power LED floodlight for indoor and outdoor architectural lighting for both residential and professional applications, such as façades, gardens, green areas and walkways. Available in 2 sizes and 3 power steps (10 W, 20 W and 30 W), the range allows for great flexibility with its multiple possible combinations: 2 colour temperature options (3,000 K warm white and 4,000 K neutral white) with a colour rendering index of more than 80, and 2 optics options (100° or asymmetrical). The fixture is equipped with an integrated On/Off electronic power supply, and it is also available with an integrated motion and luminosity sensor. The luminaire can be ceiling, wall or floor-mounted through the integrated adjustable steel bracket, and thanks to its black powder-coated die-cast aluminium body and its front glass, it is tough, durable and able to withstand harsh environmental conditions.

GENERAL INFORMATION		OPTIC AND ILLUMINATING FEATURES	
Context	Residential facades, outdoor areas and garden lighting	Optic	100°
Luminaire	Low-power LED floodlight	Unified Glare Rating	ULOR = 0%
Application	Indoor / Outdoor	Lumen output (lm)	2300
Unique digital code (Datamatrix)	Currently not present	Efficacy (lm/W)	115
Colour	Black	Colour temperature	3000 K
Type of light source	LED	Colour Rendering Index	CRI 80
System power	20 W	Standard Deviation Colour Matching	SDCM = 5
LED Lifetime	L80B50 (Tq=25°C) > 90.000 h	Photobiological Risk Class	RG1
Weight (kg)	0.7	Standard	EN 60598-1; EN 60598-2-5; IEC/TR 62778; EN 62493
Warranty	5 years	ELECTRICAL AND LIGHTING FEATURES	
Stocking temperature	-40° +80°	Supply voltage	220-240 V
Operating temperature	-30° +50°	Rated frequency (Hz)	50/60 Hz
MATERIALS		Driver	Built-in
Body	Die-cast aluminium	Driver failure rate	F10 (Tq=25°C) > 80.000 h
Shield type	Tempered 4mm-thick surface glass with Gewiss logo	Overvoltage protection	DM 1KV / CM 2KV
Optic	High-efficiency lens and reflector unit	Control System	ON / OFF
Gasket	-	INSTALLATION AND MAINTENANCE	
Locking Hook	-	Mounting and installation	Ceiling - Wall - Floor
External screw	Stainless steel	Tilt	Rotation on bracket
Colour	Powder coating	Wiring	With power cable
STANDARDS AND APPROVALS		Fixing	Via integrated bracket
Classification	-	Light source replaceability	Non-replaceable
Device with reduced surface temperature	-	Controlgear replaceability	Non-replaceable
DIN 18032-3 certification	-	Driver Box	Built-in
IPEA	Green Areas A3+	Maximum surface exposed to the wind	0,02 m2
Insulation class	I		-
IP degree	IP66		-
Mechanical resistance	IK08		-
Glow Wire Test	750 °C		-

DIMENSIONAL



PHOTOMETRIC DISTRIBUTION

TECHNICAL SYMBOLOGY



IP
IP66

IK
IK08

GWT
750 °C



Product Data Sheet
GWF1100BL830

ELIA FL Mini

STANDARDS/APPROVALS

