



CorePro LED PLC 2P

CorePro LED PLC 8.5W 840 2P G24d-3

CorePro LED PLC 2P integrates a LED light source into a traditional fluorescent form factor. This product is the ideal solution for uplamping in general lighting applications: it meets basic lighting requirements, offers significant energy savings, and is environmentally friendly.

Product data

General Information		Temperature	
Cap-Base	G24D-3 [G24d-3]	Warm-up time to 60% light	0.5 s
Nominal lifetime	30,000 hour(s)	Power Factor (Fraction)	0.9
Switching Cycle	50,000	Voltage (Nom)	220-240 V
Lighting Technology	LED	Temperature	
Flux measurement reference	Sphere	Ambient temperature range	-20 °C to 35 °C
Light Technical		T-Case Maximum (Nom)	75 °C
Color Code	840 [CCT of 4000K]	Controls and Dimming	
Beam Angle (Nom)	120 degree(s)	Dimmable	No
Luminous Flux	1,000 lumen	Mechanical and Housing	
Color Designation	Cool White (CW)	Bulb Material	Plastic
Correlated Color Temperature (Nom)	4000 K	Product Length	200 mm
Luminous Efficacy (rated) (Nom)	105.88 lm/W	Bulb Shape	Tube, single-ended
Color Consistency	<6	Approval and Application	
Color rendering index (CRI)	83	Energy Saving Product	Yes
LLMF At End Of Nominal Lifetime (Nom)	70 %	Approval Marks	TUV CE marking RoHS compliance KEMA Keur certificate
Operating and Electrical		Energy Consumption kWh/1000 h	9 kWh
Line Frequency	50 to 60 Hz	EPREL Registration Number	403,555
Input Frequency	50 to 60 Hz	CE mark	Yes
Power Consumption	8.5 W		
Starting Time (Nom)	0.5 s		

CorePro LED PLC 2P

EU RoHS compliant	Yes
Product Data	
Full product code	871869654125800
Order product name	CorePro LED PLC 8.5W 840 2P G24d-3
Order code	929001201302
Numerator - Quantity Per Pack	1

Numerator - Packs per outer box	10
Material number (12NC)	929001201302
Full product name	CorePro LED PLC 8.5W 840 2P G24d-3
EAN/UPC - Case	8718696541265

Dimensional drawing

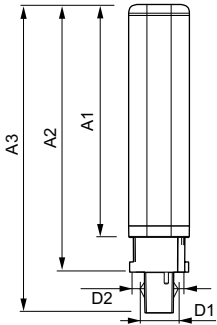

Product	D1	D2	A1	A2	A3
CorePro LED PLC 8.5W 840 2P G24d-3	24.3 mm	28.4 mm	128.8 mm	148 mm	170.6 mm

Photometric data

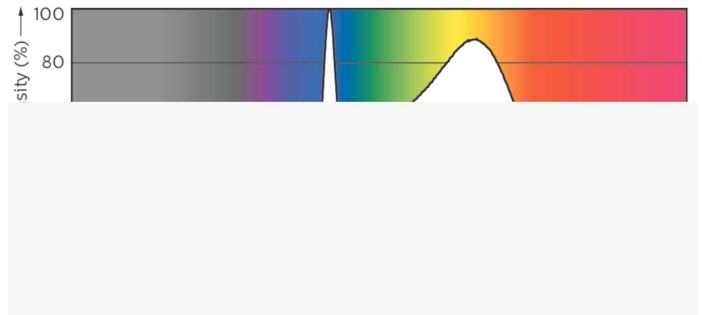
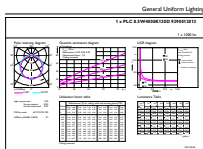

Spectral Power Distribution Colour - CorePro LED PLC 8.5W 840 2P G24d-3

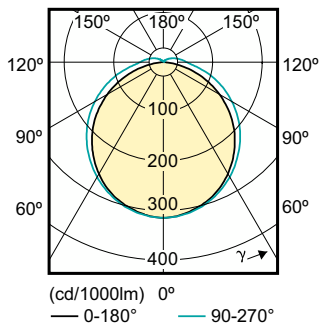

Light Distribution Diagram - CorePro LED PLC 8.5W 840 2P G24d-3

CorePro LED PLC 2P

Lifetime

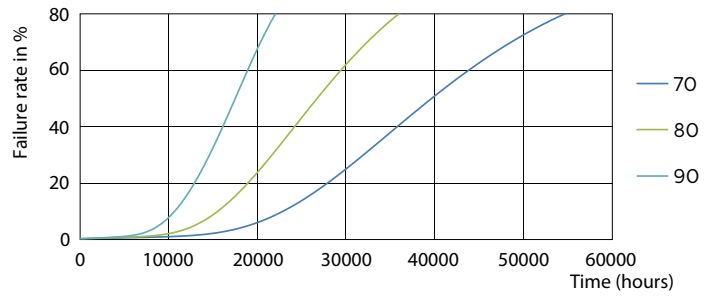

Life Expectancy Diagram - CorePro LED PLC 8.5W 840 2P G24d-3

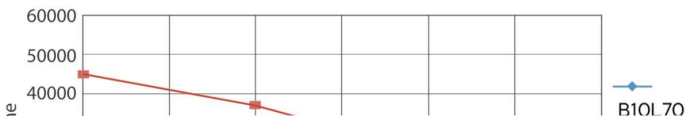

Life Expectancy Diagram - CorePro LED PLC 8.5W 840 2P G24d-3

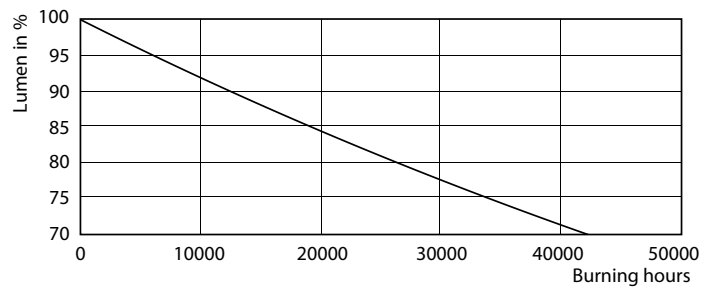

Life Expectancy Diagram - CorePro LED PLC 8.5W 840 2P G24d-3

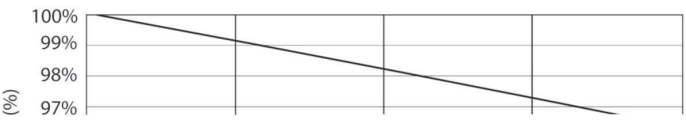

Lumen Maintenance Diagram - CorePro LED PLC 8.5W 840 2P G24d-3

Lumen Maintenance Diagram - CorePro LED PLC 8.5W 840 2P G24d-3

CorePro LED PLC 2P

