

XUK8TAE1MM12 / XUK8TAE2MM12 Diffuse distance sensor with background suppression

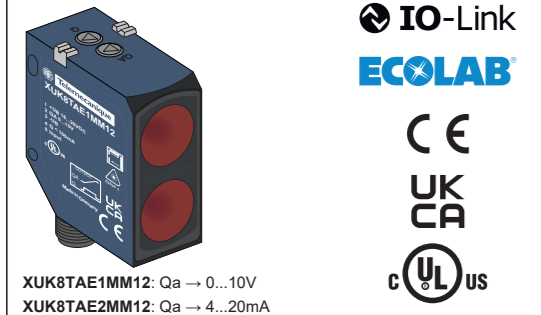

XUK8TAE1MM12: Qa → 0...10V
XUK8TAE2MM12: Qa → 4...20mA

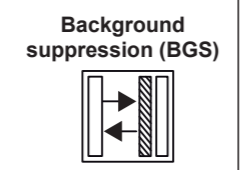
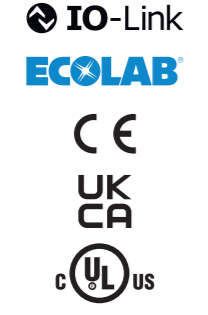

Scan the Qr-code to access this Instruction Sheet in different languages or you can download it from our website at: [www.tesensors.com](https://tesensors.com)

We welcome your comments about this document. You can reach us through the customer support page on your local website.

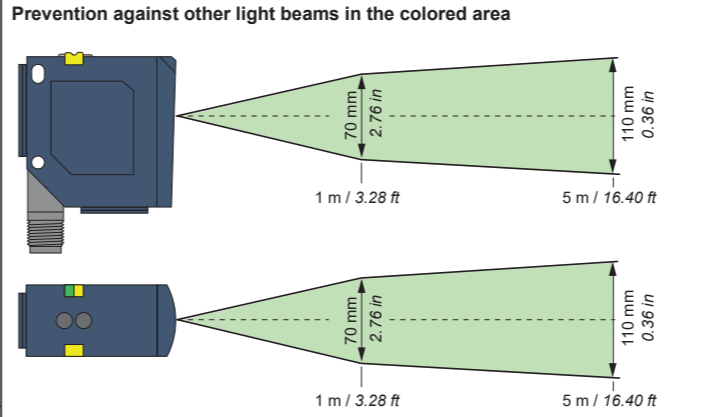

Adjustment
Adjustment of light spot position with optional mounting angle bracket XUZASK004.

Align sensor to the target object.
Observe the preferential direction of proximity switches.

Mounting and Tightening torques

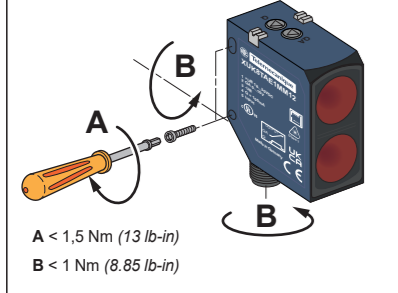

LEDs and Setting

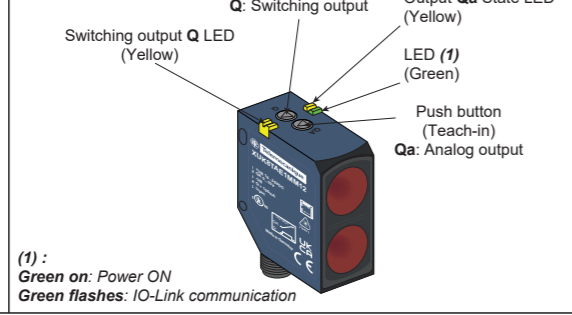

Dimensions

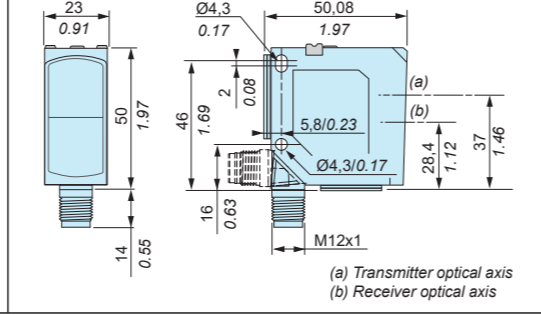

Wiring diagrams

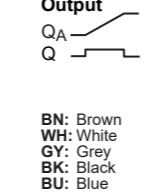
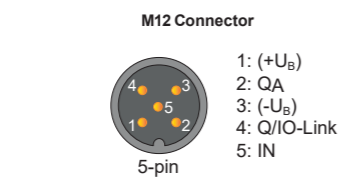
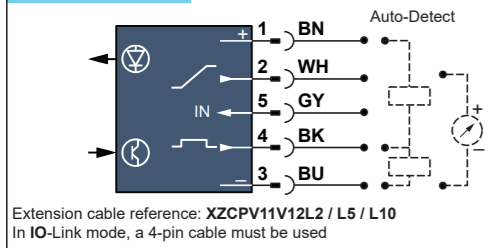

Wiring precautions
Use certified CYJV or R/C CYJV2 cable assemblies

Detection curves

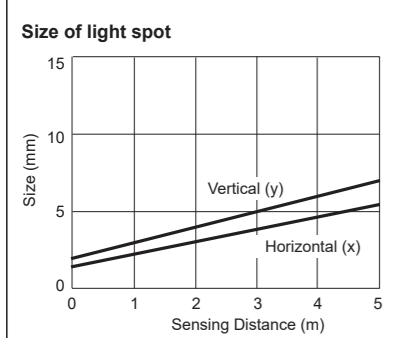
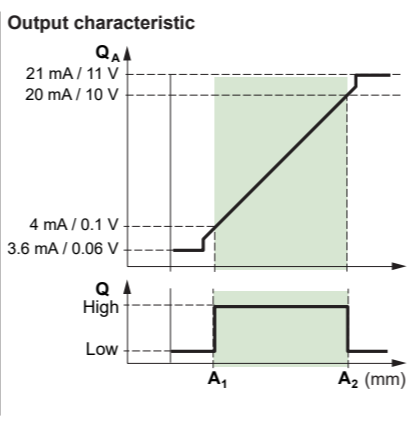
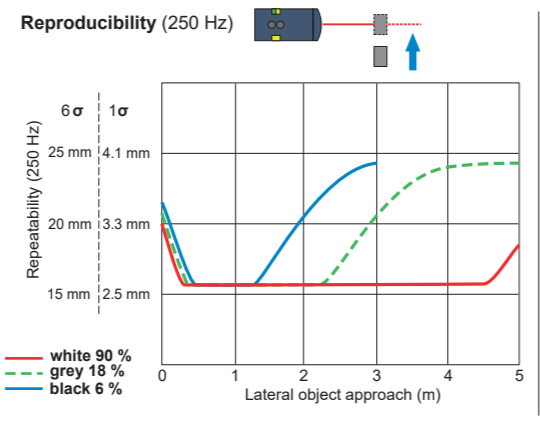
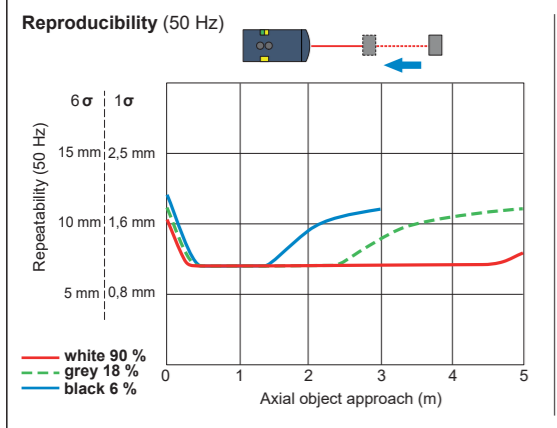

Manufacturer :
Schneider Electric Industries SAS
35 rue Joseph Monier
92500 Rueil Malmaison
France

UK Representative :
Schneider Electric Limited
Stafford Park 5
Telford, TF3 3BL
United Kingdom

Уполномоченный поставщик в РФ :
АО «Шнейдер Электрик»
Адрес: 127018, Россия, г. Москва, ул. Двинцев, д.12, корп.1
Тел. +7 (495) 777 99 90
Факс +7 (495) 777 99 92

Қазақстан Республикасында ресми жеткізуші :
ЖШС «Шнейдер Электрик»
Мекен-жайы: Қазақстан Республикасы, Алматы қ., Достық даң., «Кен Дала» Бизнес Орталығы, 5-ші қабат.
Тел.: +7 (727) 357 23 57
Факс.: +7(727) 357 24 39

Characteristics

Certification	CE - UKCA - cULus - Ecolab	
Sensing distance (Reference material)	White	0,1...5 m / 0,33...16,4 ft
	Grey	0,1...5 m / 0,33...16,4 ft
	Black	0,1...3 m / 0,33...9,84 ft
Setting	Teach button	
Color of detection light beam	Laser class 1, red, 655 nm	
Spot size of the light beam	see "Light beam size" curve	
	Wavelength	λ = 655 nm
	Puls duration	t < 5 ns
	Frequency	f = 62,5 kHz
	Limit of radiant power pulse	Pp < 1,25 mW
Switching output Q	Auto-Detect PNP/NPN (N.O. or N.C.) - IOLINK	
Control input IN (switching function Q): see illustration G	+U _B	= Teach-in
	-U _B	= button locked
	Open	= normal function
Current consumption	≤ 60 mA	
Switching capacity	≤ 100 mA	
Analog output QA	XUK8TAE1MM12	0...10 V
	XUK8TAE2MM12	4...20 mA
Switching frequency	≤ 500 Hz	
First-up delay	300 ms max.	
Response time	1,2 ms max.	
Recovery time	1,2 ms max.	
Ambient Temperature	Operating : - 20...+60 °C (-4...+140 °F) Storage : - 20...+80 °C (-4...+176 °F)	
Power Voltage	Rated operational voltage: 24 Vdc Ripple p-p 10% maximum Operating range: 18...30 Vdc (including ripple)	
Product Protection	Power supply : Reverse polarity protection Output: Short circuit protection	
Protection class		
Degree of protection	IP67 conforming to EN/IEC 60529 IP69K conforming to DIN 40050	
Vibration resistance	Frequency range: 10 Hz to 55 Hz Acceleration: 7 gn	
Shock resistance	Peak acceleration: 10 gn Duration of the pulse: 11 ms	
Permitted cable length	100 m / 328,1 ft	
Material	Housing: ABS/PC, Lens: PMMA	

IO-Link Data sheet and IODD IO-Link on website: <https://tesensors.com/iolink>

WARNING
UNINTENDED EQUIPMENT OPERATION

- Comply with the wiring and configuration instructions.
- Clean the lens regularly, taking care not to scratch it.
- Check the connections and fixings during maintenance operations.

Failure to follow these instructions can result in death, serious injury or equipment damage.

CAUTION
HAZARD OF LASER RADIATION EXPOSURE

CLASS 1 LASER PRODUCT (IEC 60825-1: 2014)
Complies with 21 CFR 1040.10 and 1040.11 except for deviations pursuant to laser Notice No. 56 dated May, 2019

Accessories

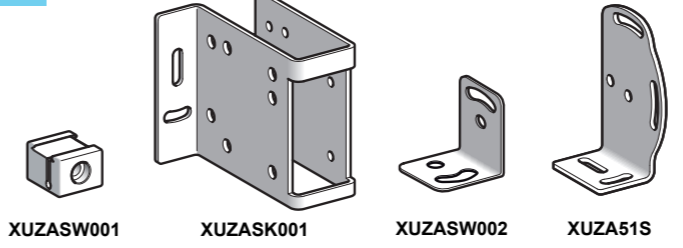

Electrical equipment should be installed, operated, serviced, and maintained only by qualified personnel.
No responsibility is assumed by Schneider Electric for any consequences arising out of the use of this material.
© 2022 Schneider Electric. "All Rights Reserved."

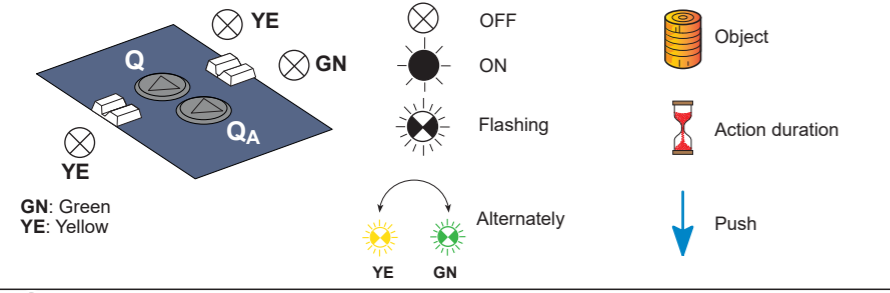

Setting
 The sensor has an analogue and a switching output, which can be set independent of each other.
Analog output: The two teach points identify the beginning and end of the measuring area and scale the analog output (see Chapter B).
 Teach 1: 4 mA / 0,1 V.
 Teach 2: 20 mA / 10 V.
Switching output: The two teaching points identify the beginning and end of the switching window (see Chapter C).
Setting modes: The teach sequence and object distance determine the characteristics of the analog output Q_A and the window width of the switching output Q (see Chapter D).

A Overview

Function	Action Step 1 (1)	External teach	See illustration
Analog characteristic	press Q _A > 3 s	connect IN > 3 s	B
Switching window	press Q > 3 s	connect IN > 6 s	C
N.O. / N.C.	press Q > 10 s	connect IN > 10 s	E
Auto-Detect / NPN / PNP	press Q > 13 s	connect IN > 13 s	F

(1) Step 2: press Q_A (or Q) / connect IN > 1 s

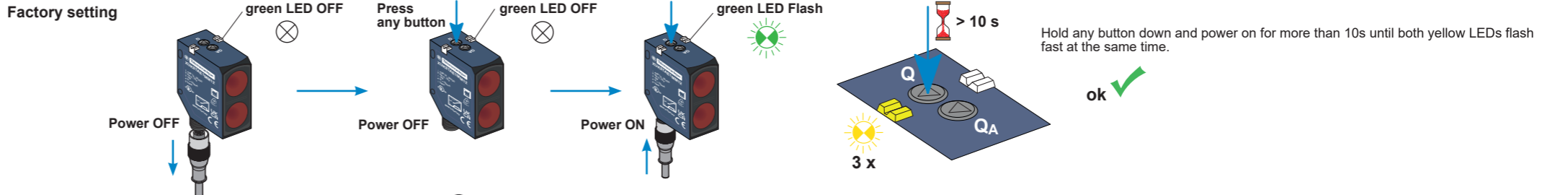

B Analog Output

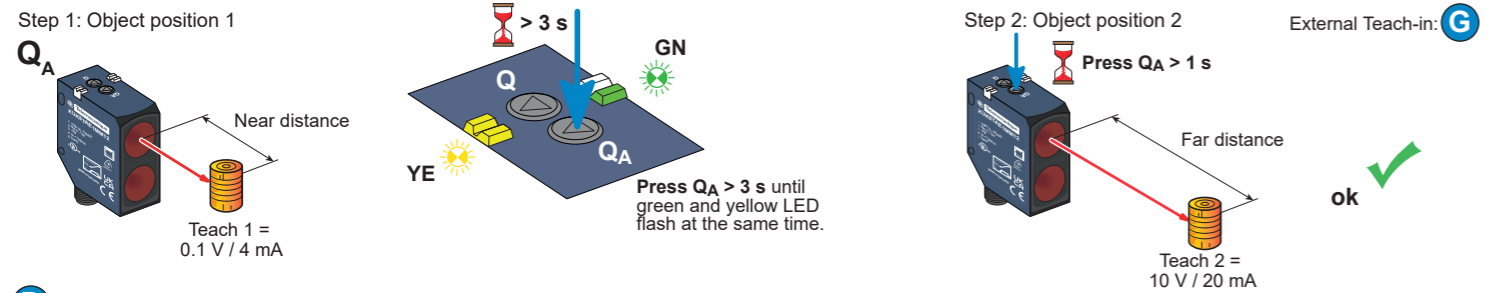

C Switching Output

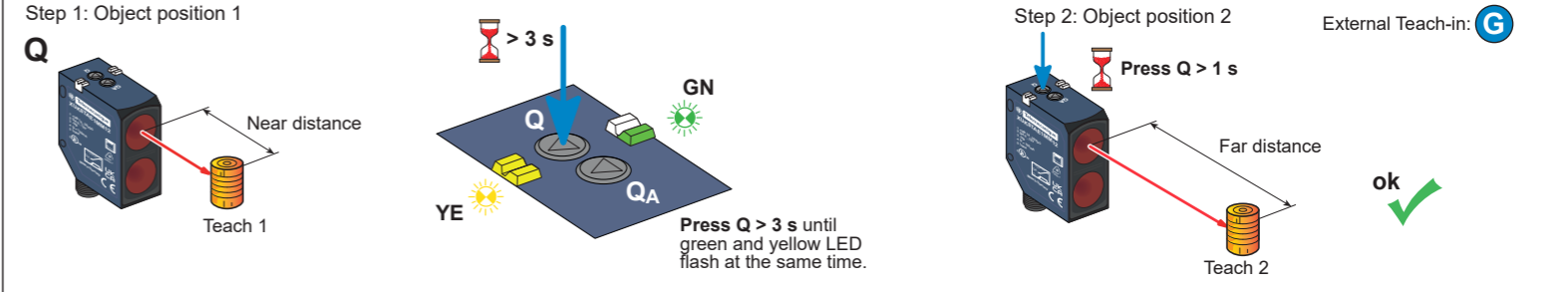

D Setting modes

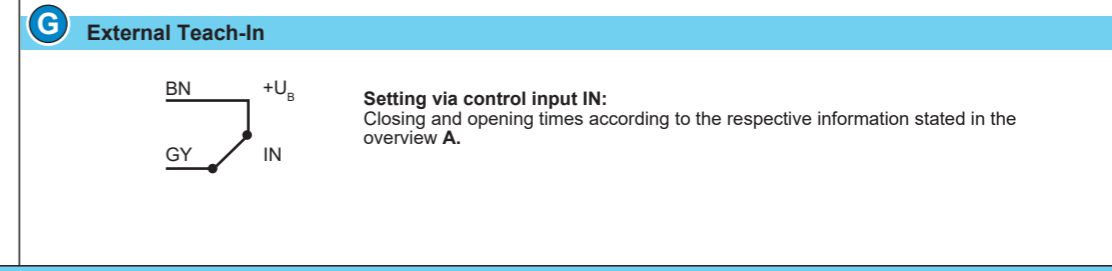
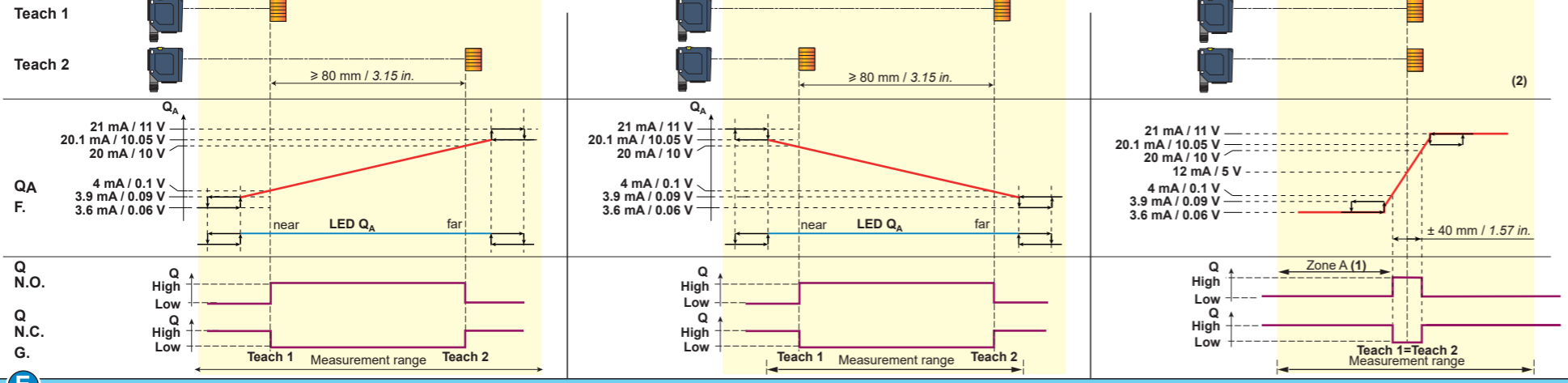

E Switching N.O./N.C./Slope

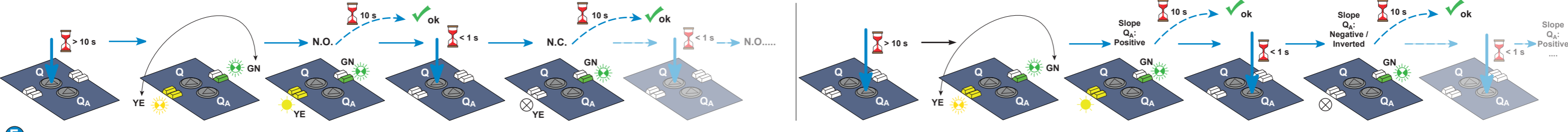

F Switching Auto-detect/NPN/PPNP/UI

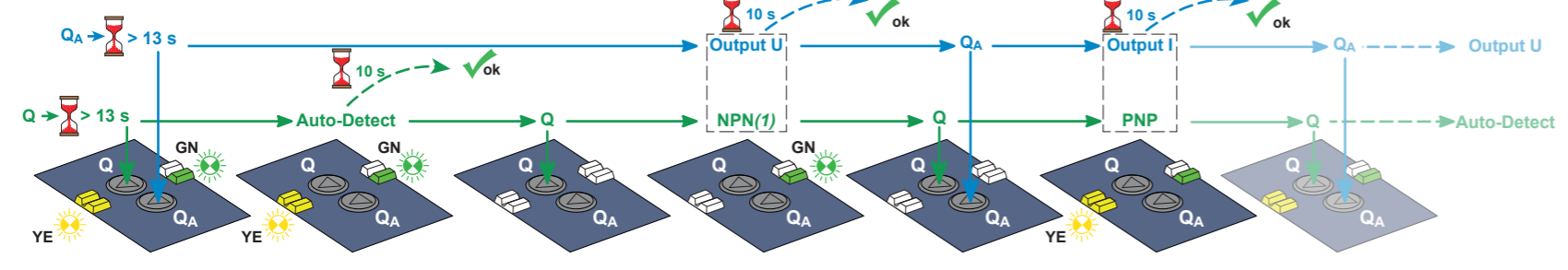

(1): IO-link is specified for PNP
 Press Q > 13 s until green and yellow LED flash at the same time.