

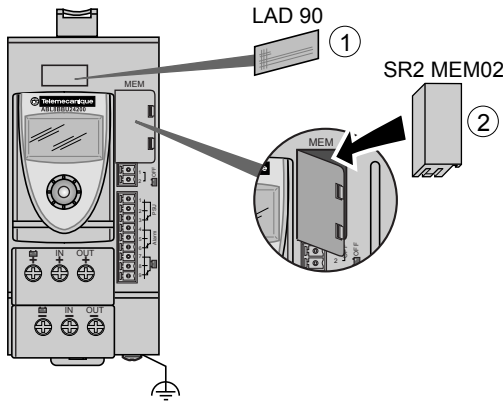

**ABL 8BBU24200**

U<sub>in</sub> = 22...28,8 V  
 U<sub>out</sub> = 24 V, I<sub>out</sub> 20 A  
 21...28 V



**ABL 8BBU24400**

U<sub>in</sub> = 22...28,8 V  
 U<sub>out</sub> = 24 V, I<sub>out</sub> 40 A  
 21...28 V

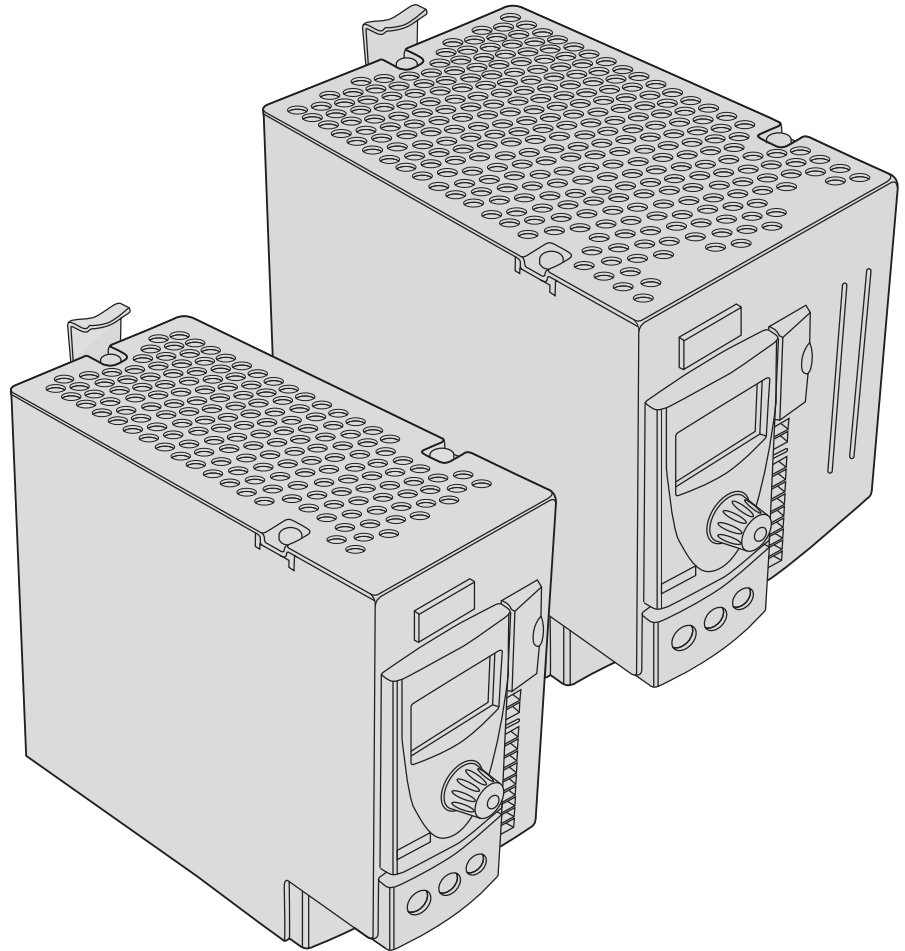
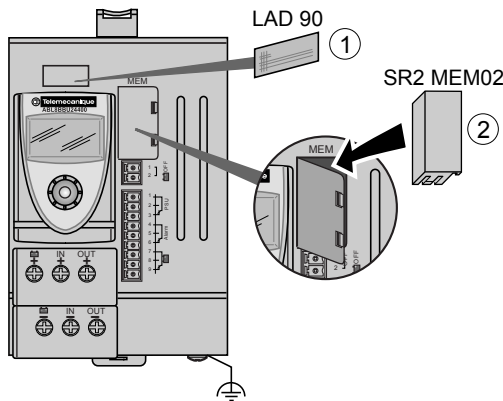

EN 1489436 10 A01  
 FR 1489436 09 A01

**1 LAD 90**

- EN Snap-on label
- FR Repère encliquetable
- DE Etikettenhalter
- ES Marcador con enganche
- IT Contrassegno aganciabile.
- PT Marca de engatar

**2 SR2 MEM02**

- EN Storage cartridge ordered separately
- FR Cartouche mémoire à commander séparément
- DE Einbau Speicherkartusche, getrennt zu bestellen
- ES Cartucho de memoria que encargar aparte
- IT Cartuccia memoria da ordinare separatamente
- PT Cartucho de memória a encomendar separadamente

- EN Electrical equipment should be installed, operated, serviced, and maintained only by qualified personnel. No responsibility is assumed by Schneider Electric for any consequences arising out of the use of this material.
- FR Les équipements électriques doivent être installés, exploités et entretenus par un personnel qualifié. Schneider Electric n'assume aucune responsabilité des conséquences éventuelles découlant de l'utilisation de cette documentation.
- DE Elektrische Geräte dürfen nur von Fachpersonal installiert, betrieben, gewartet und instand gesetzt werden. Schneider Electric haftet nicht für Schäden, die aufgrund der Verwendung dieses Materials entstehen.
- ES Sólo el personal de servicio cualificado podrá instalar, utilizar, reparar y mantener el equipo eléctrico. Schneider Electric no asume las responsabilidades que pudieran surgir como consecuencia de la utilización de este material.
- IT Le apparecchiature elettriche devono essere installate, usate e riparate solo da personale qualificato. Schneider Electric non assume nessuna responsabilità per qualunque conseguenza derivante dall'uso di questo materiale.
- PT O equipamento eléctrico só deve ser instalado, utilizado e reparado por técnicos especializados. A Schneider Electric não assume qualquer responsabilidade por quaisquer consequências decorrentes da utilização deste material.
- EN Supply by Recognized Component (NMTR2, NMTR8), Telemecanique (E164867), Model ABL8 series.
- FR Alimenté par Recognized Component (NMTR2, NMTR8), Telemecanique (E164867), Modèle de la série ABL8.
- DE Stromversorgung durch Recognized Component (NMTR2, NMTR8), Telemecanique (E164867), Modell der Serie ABL8.
- ES Alimentado por Recognized Component (NMTR2, NMTR8), Telemecanique (E164867), Modelo serie ABL8.
- IT Alimentazione con Recognized Component (NMTR2, NMTR8), Telemecanique (E16487), Modello serie ABL8.
- PT Alimentado por Recognized Component (NMTR2, NMTR8), Telemecanique (E164867), Modelo da série ABL8.

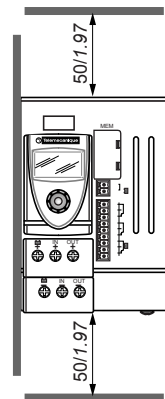
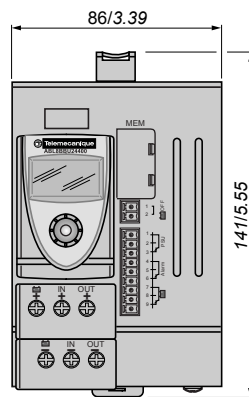
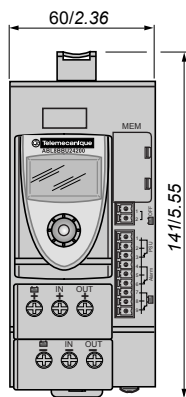
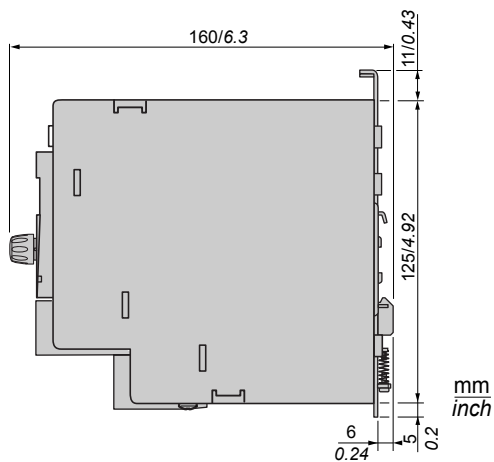

A

- EN Mounting
- FR Montage
- DE Montage
- ES Montaje
- IT Montaggio
- PT Montagem

mm  
inch

AM1 DE200  
IEC/EN 60715

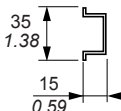

AM1 ED200

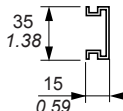

AM1 DP200

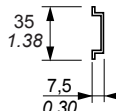

DZ5 MB200

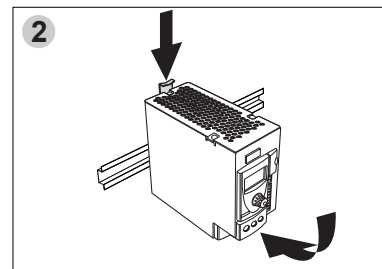
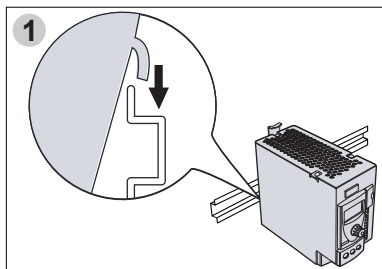

**⚠ DANGER / DANGER / GEFAHR / PELIGRO / PERICOLO / PERIGO**

**HAZARD OF ELECTRIC SHOCK, EXPLOSION OR ARC FLASH**

- Disconnect all power before servicing equipment and remove the battery fuse before wiring or assembling/disassembling the equipment.

**Failure to follow these instructions will result in death or serious injury.**

**RISQUE D'ELECTROCUTION, D'EXPLOSION OU D'ARC ELECTRIQUE**

- Coupez l'alimentation avant de travailler sur cet appareil et ôtez le fusible de la batterie avant câblage ou montage, démontage de l'appareil.

**Le non-respect de ces instructions provoquera la mort ou des blessures graves.**

**STROMSCHLAG-, EXPLOSIONS- ODER LICHTBOGENGEFAHR**

- Vor dem Arbeiten an dem Gerät dessen Stromversorgung abschalten ab und entfernen Sie die Sicherung der Batterie entfernen, bevor Sie das Gerät verkabeln, montieren oder demontieren.

**Die Nichtbeachtung dieser Anweisungen führt zu Tod oder schwerer Körperverletzung.**

**RIESGO DE ELECTROCUCIÓN, EXPLOSIÓN O ARCO ELÉCTRICO**

- Desconecte toda alimentación antes de realizar el servicio y retirar el fusible de la batería antes del cableado o montaje-desmontaje del aparato.

**Si no se siguen estas instrucciones provocará lesiones graves o incluso la muerte.**

**RISCHIO DI SCOSSA ELETTRICA, DI ESPLOSIONE O DI OFTALMIA DA FLASH**

- Scollegare l'apparecchio dalla presa di corrente prima di qualsiasi intervento e togliere il fusibile della batteria prima di eseguire il cablaggio, il montaggio o lo smontaggio dell'apparecchio.

**Il mancato rispetto di queste istruzioni provocherà morte o gravi infortuni.**

**RISCO DE CHOQUE ELÉCTRICO, EXPLOSIÃO OU FAÍSCA**

- Desligue a alimentação antes de trabalhar neste aparelho e retirar o fusível da bateria antes de ligar os cabos ou montar/desmontar o aparelho.

**A não observância destas instruções resultará em morte, ou ferimentos graves.**

**⚠ WARNING / AVERTISSEMENT / WARNUNG / ADVERTENCIA / AVVERTENZA / AVISO**

**ACID BURNS, OVERHEATING OR SHORT CIRCUIT**

- Handle with care. Batteries will leak acid if not handled properly.

- Follow proper mounting instructions including torque values and the crimping lengths on wire terminations.

- Do not allow liquids or foreign objects to enter this product.

**Failure to follow these instructions can result in death, serious injury or equipment damage.**

**BRULURES A L'ACIDE, SURCHAUFFE OU COURT-CIRCUIT**

- Manipuler avec précautions. Des fuites d'acide peuvent se produire si les batteries ne sont pas manipulées correctement.

- Respecter les consignes de montage, et notamment les couples de serrage et les longueurs de sertissage sur les terminaisons de câble.

- Ne pas laisser pénétrer de liquide ni de corps étrangers à l'intérieur du produit.

**Le non-respect de ces instructions peut provoquer la mort, des blessures graves ou des dommages matériels.**

**VERÄTZUNGEN, ÜBERHITZUNG ODER KURZSCHLUSS**

Bitte vorsichtig behandeln. Säure tritt aus den Batterien aus, wenn diese nicht sachgemäß behandelt werden.

- Beachten Sie die Montageanweisungen, insbesondere die Anziehdrehmomente und die Crimplängen an den Kabelenden.

- Führen Sie keine Flüssigkeiten oder Fremdkörper in das Produkt ein.

**Die Nichtbeachtung dieser Anweisungen kann zu Körperverletzungen oder Materialschäden führen.**

**QUEMADURAS DE ÁCIDO, SOBREAQUECIMIENTO O CORTOCIRCUITO**

- Manejar con cuidado. Las baterías pueden chorrear ácido si no se manejan correctamente.

- Respetar las instrucciones de montaje, y en particular los pares de apretado y las longitudes de engaste en las terminaciones de los cables.

- No dejar que penetren líquidos o cuerpos extraños en el producto.

**Si no se siguen estas instrucciones pueden producirse lesiones personales graves o mortales o daños en el equipo**

**BRUCIATURE DA ACIDO, SURRISCALDAMENTO O CORTOCIRCUITO**

- Maneggiare con cura. Se le batterie non sono maneggiate correttamente, può fuoriuscire acido.

- Seguire le istruzioni di montaggio corrette che comprendono i valori di coppia e le lunghezze di crimpatura sulle terminazioni dei cavi.

- Non far entrare liquidi o oggetti estranei in questo apparecchio.

**Il mancato rispetto di queste istruzioni può provocare infortuni o danni alle apparecchiature.**

**QUEIMADURAS DE ÁCIDO, SOBREAQUECIMENTO OU CURTO-CIRCUITO**

- Manusear com cuidado. As baterias vertem ácido se não forem devidamente manuseadas.

- Siga devidamente as instruções de montagem, incluindo as forças de aperto e os comprimentos de enrolamento nos terminais de cabos.

- Não permita a entrada de líquidos e de objectos estranhos no produto.

**A não observância destas instruções pode provocar a morte, ferimentos graves, ou danos no equipamento.**

IEC / EN

	<b>ABL 8RPS24030</b> <b>8RPS24050</b> <b>8RPS24100</b>	<b>ABL 8RPM24200</b> <b>8WPS24200</b> <b>8WPS24400</b>
$\varnothing \leq 4 \text{ mm}^2$	In + / - + / - Out + / -	1...4 mm <sup>2</sup> 6 mm <sup>2</sup> 6 mm <sup>2</sup>
$\varnothing > 4 \text{ mm}^2$	In + / - + / - Out + / - $\ominus \oplus$	4...10 mm <sup>2</sup> - - 10 mm <sup>2</sup> 10 mm <sup>2</sup> 10 mm <sup>2</sup>
		0,14...1 mm <sup>2</sup>

UL

	<b>ABL 8RPS24030</b> <b>8RPS24050</b> <b>8RPS24100</b>	<b>ABL 8RPM24200</b> <b>8WPS24200</b> <b>8WPS24400</b>
$\varnothing \leq 12 \text{ AWG}$	In + / - + / - Out + / -	16...12 AWG 10 AWG 10 AWG
$\varnothing > 12 \text{ AWG}$	In + / - + / - Out + / - $\ominus \oplus$	12...6 AWG - - 16...12 AWG 12...6 AWG 6 AWG 6 AWG 6 AWG
		26...16 AWG

**B**

- EN** Wiring
- FR** Câblage
- DE** Verkabelung
- ES** Cableado
- IT** Cablaggio
- PT** Cablagem

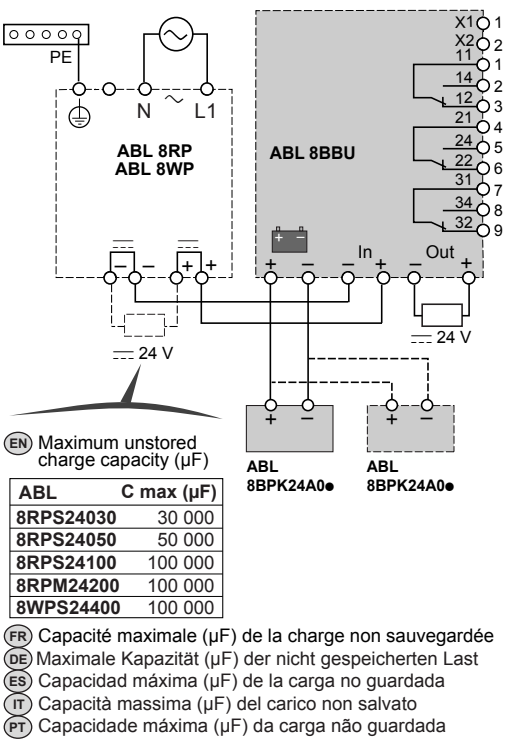
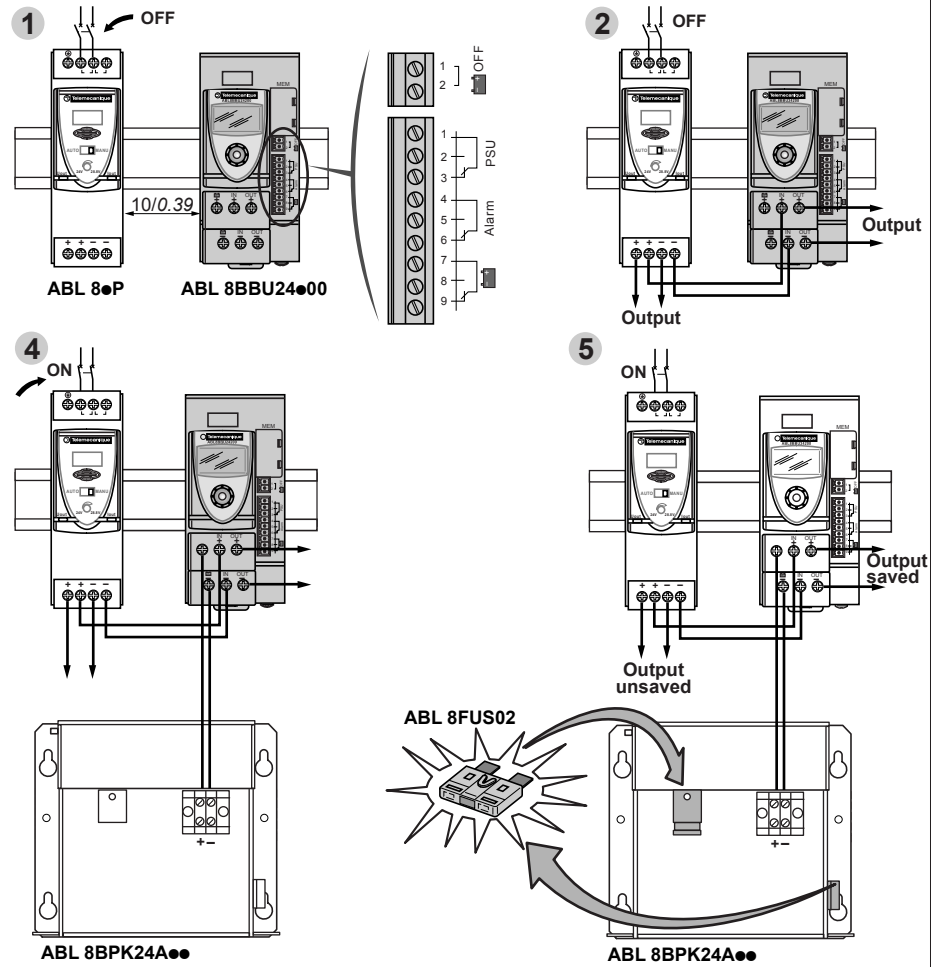

Outputs / Sorties / Ausgänge / Salidas / Uscite / Saídas																									
U = ~ 24 V : I > 5 mA, U = 230 V : I < 500 mA																									
<table border="1"> <tr><td>11</td><td><b>EN</b> No power from the power supply</td></tr> <tr><td>14</td><td><b>FR</b> Absence d'alimentation secteur</td></tr> <tr><td>12</td><td><b>DE</b> Kein Strom aus Stromversorgung</td></tr> <tr><td></td><td><b>ES</b> No hay alimentación de la fuente</td></tr> <tr><td></td><td><b>IT</b> Nessuna potenza erogata dall'alimentatore</td></tr> <tr><td></td><td><b>PT</b> Não há alimentação da fonte</td></tr> </table>	11	<b>EN</b> No power from the power supply	14	<b>FR</b> Absence d'alimentation secteur	12	<b>DE</b> Kein Strom aus Stromversorgung		<b>ES</b> No hay alimentación de la fuente		<b>IT</b> Nessuna potenza erogata dall'alimentatore		<b>PT</b> Não há alimentação da fonte	<table border="1"> <tr><td>11</td><td><b>EN</b> Power from the power supply</td></tr> <tr><td>14</td><td><b>FR</b> Alimentation secteur</td></tr> <tr><td>12</td><td><b>DE</b> Strom aus Stromversorgung</td></tr> <tr><td></td><td><b>ES</b> Alimentación de la fuente</td></tr> <tr><td></td><td><b>IT</b> Potenza erogata dall'alimentatore</td></tr> <tr><td></td><td><b>PT</b> Alimentação da fonte</td></tr> </table>	11	<b>EN</b> Power from the power supply	14	<b>FR</b> Alimentation secteur	12	<b>DE</b> Strom aus Stromversorgung		<b>ES</b> Alimentación de la fuente		<b>IT</b> Potenza erogata dall'alimentatore		<b>PT</b> Alimentação da fonte
11	<b>EN</b> No power from the power supply																								
14	<b>FR</b> Absence d'alimentation secteur																								
12	<b>DE</b> Kein Strom aus Stromversorgung																								
	<b>ES</b> No hay alimentación de la fuente																								
	<b>IT</b> Nessuna potenza erogata dall'alimentatore																								
	<b>PT</b> Não há alimentação da fonte																								
11	<b>EN</b> Power from the power supply																								
14	<b>FR</b> Alimentation secteur																								
12	<b>DE</b> Strom aus Stromversorgung																								
	<b>ES</b> Alimentación de la fuente																								
	<b>IT</b> Potenza erogata dall'alimentatore																								
	<b>PT</b> Alimentação da fonte																								
<table border="1"> <tr><td>21</td><td><b>EN</b> Alarm - Or device not supplied</td></tr> <tr><td>24</td><td><b>FR</b> Alarm - Ou produit non alimenté</td></tr> <tr><td>22</td><td><b>DE</b> Alarm - Or device not supplied</td></tr> <tr><td></td><td><b>ES</b> Alarm - Or device not supplied</td></tr> <tr><td></td><td><b>IT</b> Alarm - Or device not supplied</td></tr> <tr><td></td><td><b>PT</b> Alarm - Or device not supplied</td></tr> </table>	21	<b>EN</b> Alarm - Or device not supplied	24	<b>FR</b> Alarm - Ou produit non alimenté	22	<b>DE</b> Alarm - Or device not supplied		<b>ES</b> Alarm - Or device not supplied		<b>IT</b> Alarm - Or device not supplied		<b>PT</b> Alarm - Or device not supplied	<table border="1"> <tr><td>21</td><td><b>EN</b> No alarm</td></tr> <tr><td>24</td><td><b>FR</b> Pas d'alarme</td></tr> <tr><td>22</td><td><b>DE</b> Kein Alarm</td></tr> <tr><td></td><td><b>ES</b> Sin alarma</td></tr> <tr><td></td><td><b>IT</b> Nessun allarme</td></tr> <tr><td></td><td><b>PT</b> Sem alarme</td></tr> </table>	21	<b>EN</b> No alarm	24	<b>FR</b> Pas d'alarme	22	<b>DE</b> Kein Alarm		<b>ES</b> Sin alarma		<b>IT</b> Nessun allarme		<b>PT</b> Sem alarme
21	<b>EN</b> Alarm - Or device not supplied																								
24	<b>FR</b> Alarm - Ou produit non alimenté																								
22	<b>DE</b> Alarm - Or device not supplied																								
	<b>ES</b> Alarm - Or device not supplied																								
	<b>IT</b> Alarm - Or device not supplied																								
	<b>PT</b> Alarm - Or device not supplied																								
21	<b>EN</b> No alarm																								
24	<b>FR</b> Pas d'alarme																								
22	<b>DE</b> Kein Alarm																								
	<b>ES</b> Sin alarma																								
	<b>IT</b> Nessun allarme																								
	<b>PT</b> Sem alarme																								
<table border="1"> <tr><td>31</td><td><b>EN</b> No power from the battery pack</td></tr> <tr><td>34</td><td><b>FR</b> Absence d'alimentation depuis le bloc batterie</td></tr> <tr><td>32</td><td><b>DE</b> Kein Strom aus Batteriepack</td></tr> <tr><td></td><td><b>ES</b> No hay alimentación de la batería</td></tr> <tr><td></td><td><b>IT</b> Nessuna potenza erogata dalle batterie</td></tr> <tr><td></td><td><b>PT</b> Não há alimentação da bateria</td></tr> </table>	31	<b>EN</b> No power from the battery pack	34	<b>FR</b> Absence d'alimentation depuis le bloc batterie	32	<b>DE</b> Kein Strom aus Batteriepack		<b>ES</b> No hay alimentación de la batería		<b>IT</b> Nessuna potenza erogata dalle batterie		<b>PT</b> Não há alimentação da bateria	<table border="1"> <tr><td>31</td><td><b>EN</b> Power from the battery pack</td></tr> <tr><td>34</td><td><b>FR</b> Alimentation depuis le bloc batterie</td></tr> <tr><td>32</td><td><b>DE</b> Strom aus Batteriepack</td></tr> <tr><td></td><td><b>ES</b> Alimentación de la batería</td></tr> <tr><td></td><td><b>IT</b> Potenza erogata dalle batterie</td></tr> <tr><td></td><td><b>PT</b> Alimentação da bateria</td></tr> </table>	31	<b>EN</b> Power from the battery pack	34	<b>FR</b> Alimentation depuis le bloc batterie	32	<b>DE</b> Strom aus Batteriepack		<b>ES</b> Alimentación de la batería		<b>IT</b> Potenza erogata dalle batterie		<b>PT</b> Alimentação da bateria
31	<b>EN</b> No power from the battery pack																								
34	<b>FR</b> Absence d'alimentation depuis le bloc batterie																								
32	<b>DE</b> Kein Strom aus Batteriepack																								
	<b>ES</b> No hay alimentación de la batería																								
	<b>IT</b> Nessuna potenza erogata dalle batterie																								
	<b>PT</b> Não há alimentação da bateria																								
31	<b>EN</b> Power from the battery pack																								
34	<b>FR</b> Alimentation depuis le bloc batterie																								
32	<b>DE</b> Strom aus Batteriepack																								
	<b>ES</b> Alimentación de la batería																								
	<b>IT</b> Potenza erogata dalle batterie																								
	<b>PT</b> Alimentação da bateria																								
Inputs / Entrées / Eingänge / Entradas / Ingressi / Entradas																									
Dry contact / Contact sans potentiel / Potentialfreier Kontakt / Contacto sin potencial / Contatto privo di potenziale / Contacto sem potencial.																									
<table border="1"> <tr><td>X1</td><td><b>EN</b> Operational battery</td></tr> <tr><td>X2</td><td><b>FR</b> Batterie opérationnelle</td></tr> <tr><td></td><td><b>DE</b> Betriebsbereite Batterie</td></tr> <tr><td></td><td><b>ES</b> Batería operativa</td></tr> <tr><td></td><td><b>IT</b> Batteria operativa</td></tr> <tr><td></td><td><b>PT</b> Bateria operacional</td></tr> </table>	X1	<b>EN</b> Operational battery	X2	<b>FR</b> Batterie opérationnelle		<b>DE</b> Betriebsbereite Batterie		<b>ES</b> Batería operativa		<b>IT</b> Batteria operativa		<b>PT</b> Bateria operacional	<table border="1"> <tr><td>X1</td><td><b>EN</b> Battery inhibited.</td></tr> <tr><td>X2</td><td><b>FR</b> Batterie inhibée.</td></tr> <tr><td></td><td><b>DE</b> Batterie unterdrückt.</td></tr> <tr><td></td><td><b>ES</b> Batería inhibida.</td></tr> <tr><td></td><td><b>IT</b> Batteria inibita.</td></tr> <tr><td></td><td><b>PT</b> Bateria inibida</td></tr> </table>	X1	<b>EN</b> Battery inhibited.	X2	<b>FR</b> Batterie inhibée.		<b>DE</b> Batterie unterdrückt.		<b>ES</b> Batería inhibida.		<b>IT</b> Batteria inibita.		<b>PT</b> Bateria inibida
X1	<b>EN</b> Operational battery																								
X2	<b>FR</b> Batterie opérationnelle																								
	<b>DE</b> Betriebsbereite Batterie																								
	<b>ES</b> Batería operativa																								
	<b>IT</b> Batteria operativa																								
	<b>PT</b> Bateria operacional																								
X1	<b>EN</b> Battery inhibited.																								
X2	<b>FR</b> Batterie inhibée.																								
	<b>DE</b> Batterie unterdrückt.																								
	<b>ES</b> Batería inhibida.																								
	<b>IT</b> Batteria inibita.																								
	<b>PT</b> Bateria inibida																								

First power-up / Première mise en service / Erste Inbetriebnahme /  
 Primer encendido / Prima messa sotto tensione /Primeira ligação

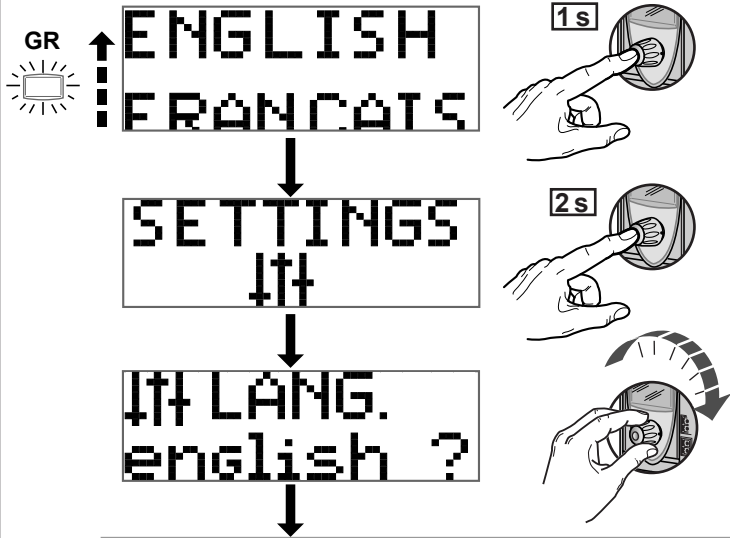

**Mandatory settings** (e.g. 1X ABL8BPK24A03 and t = 10 min) / **Réglages indispensable** (ex : 1X ABL8BPK24A03 et t=10min)  
**Einstellungen zwingend** (Beispiel: 1X ABL8BPK24A03 und t = 10 min) / **Ajustes indispensables** (ej.: 1X ABL8BPK24A03 y t = 10min)  
**Regolazioni indispensabili** (es.: 1X ABL8BPK24A03 e t =10min) / **Regulações indispensáveis** (ex : 1X ABL8BPK24A03 e t=10min)

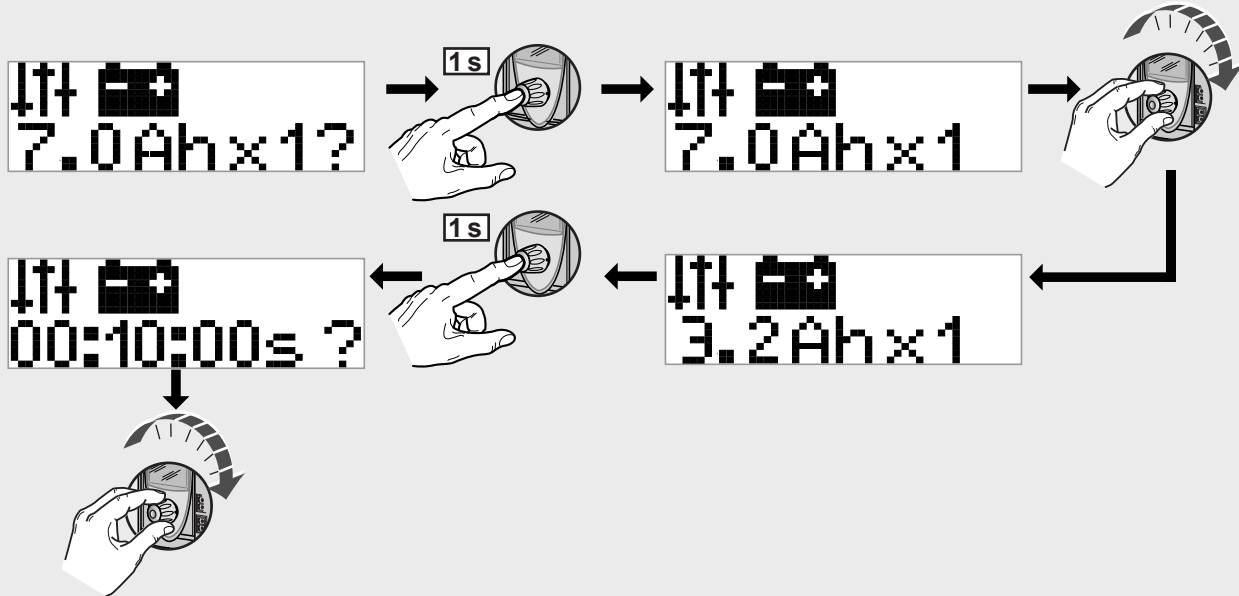



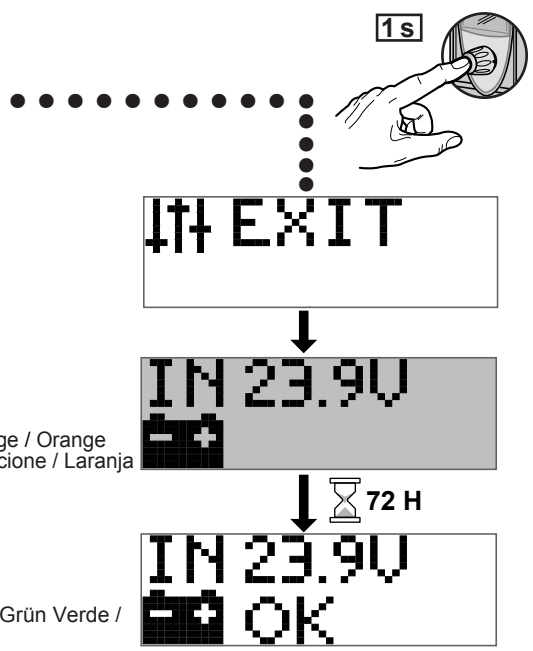
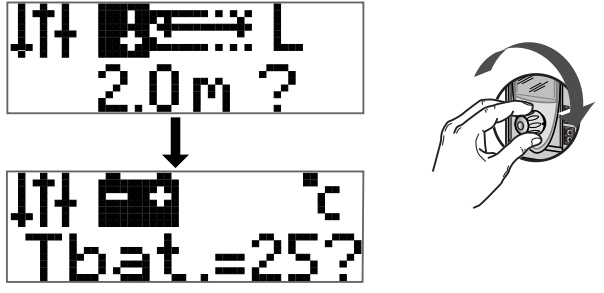



**Optional settings** / **Réglages optionnels** / **Optionale Einstellungen**  
**Ajustes opcionales** / **Regolazioni opzionali** / **Regulações opcionais**







/ Orange / Orange / Orange  
 Naranja / Arancione / Laranja

/ Green / Vert / Grün Verde /  
 Verde / Verde









EN Diagnostic display. DE Diagnostikanzeige. IT Visualizzazione della diagnostica.  
FR Visualisation du diagnostic. ES Visualización del diagnóstico. PT Visualização do diagnóstico.

 OFF  /  Green / Vert / Grün  
 Verde / Verde / Verde  /  Orange / Orange / Orange  
 Naranja / Arancione / Laranja  /  Red / Rouge / Rot / Rojo / Rosso / Vermelho  
 Alarm / Alarm / Alarm / Alarma / Allarme / Alarme

EN Power supply mode FR Mode d'alimentation DE Stromversorgungsmodus  
ES Modo de alimentación IT Modo alimentazione elettrica PT Modo de alimentação

 / 		<p> <span>EN</span> Battery fully charged  <span>FR</span> Batterie chargée à 100 %.  <span>DE</span> Batterie zu 100 % geladen.  <span>ES</span> Batería cargada al 100 %.  <span>IT</span> Batteria carica al 100 %.  <span>PT</span> Bateria carregada a 100 %.                 </p>
 / 		<p> <span>EN</span> Buffering time achievable.  <span>FR</span> Temps de sauvegarde atteignable.  <span>DE</span> Erreichbare Speicherzeit.  <span>ES</span> Tiempo de guardado alcanzable.  <span>IT</span> Tempo di backup raggiungibile.  <span>PT</span> Tempo de guarda atingível.                 </p>
 / 		<p> <span>EN</span> First charge of the battery : battery charge unknown.  <span>FR</span> Premier chargement de la batterie : charge batterie inconnue.  <span>DE</span> Erste Batterieladung: Batterieladung unbekannt.  <span>ES</span> Primera carga de la batería: carga de la batería desconocida.  <span>IT</span> Prima carica della batteria: carica della batteria non nota.  <span>PT</span> Primeira carga da bateria: carga da bateria desconhecida.                 </p>
 / 		<p> <span>EN</span> Battery fully charged: battery lifetime ≤ 50 %.  <span>FR</span> Batterie chargée à 100 % : durée de vie de la batterie ≤ 50 %.  <span>DE</span> Batterie zu 100 % vollständig geladen: Lebensdauer der Batterie ≤ 50 %.  <span>ES</span> Batería cargada al 100 % : vida útil de la batería ≤ 50 %.  <span>IT</span> Batteria carica al 100 % : durata di vita della batteria ≤ 50 %.  <span>PT</span> Bateria carregada a 100 % : tempo de vida da bateria ≤ 50 %.                 </p>
 / 		<p> <span>EN</span> Buffering time not achievable.  <span>FR</span> Temps de sauvegarde non atteignable  <span>DE</span> Nicht erreichbare Speicherzeit  <span>ES</span> Tiempo de guardado no alcanzable  <span>IT</span> Tempo di backup non raggiungibile  <span>PT</span> Tempo de guarda não atingível                 </p>
 / 		<p> <span>EN</span> No battery available.  <span>FR</span> Batterie indisponible.  <span>DE</span> Keine Batterie verfügbar.  <span>ES</span> Batería indisponible.  <span>IT</span> Nessuna batteria disponibile.  <span>PT</span> Nenhuma bateria disponível                 </p>
 / 		<p> <span>EN</span> Battery inhibited.  <span>FR</span> Batterie désactivée.  <span>DE</span> Batterie unterdrückt.  <span>ES</span> Batería inhibida.  <span>IT</span> Batteria inibita.  <span>PT</span> Bateria inibida                 </p>
 / 		<p> <span>EN</span> Battery reached end of life  <span>FR</span> Batterie en fin de vie.  <span>DE</span> Batterie am Lebensende.  <span>ES</span> Batería en fin de vida.  <span>IT</span> Batteria in fine vita.  <span>PT</span> Bateria em fim de vida.                 </p>

EN Battery mode FR Mode batterie DE Batteriemodus  
ES Modo batería IT Modo batteria PT Modo da Bateria

 / 		<p> <span>EN</span> Time remaining. Battery charge enough for the selection.  <span>FR</span> Temps restant. Charge batterie suffisante pour sélection effectuée  <span>DE</span> Restlaufzeit. Batterieladung für die Auswahl ausreichend.  <span>ES</span> Tiempo restantes. Carga de la batería suficiente para selección.  <span>IT</span> Tempo remani. Carica batteria sufficiente per selezione.  <span>PT</span> Tempo Restantes. Carga da bateria suficiente para seleção.                 </p>
 / 		<p> <span>EN</span> Time remaining. Battery charge not enough for the selection.  <span>FR</span> Temps restant. Charge batterie insuffisante pour sélection effectuée  <span>DE</span> Restlaufzeit. Batterieladung für die Auswahl nicht ausreichend.  <span>ES</span> Tiempo restantes. Carga de la batería insuficiente para selección.  <span>IT</span> Tempo remani. Carica batteria insufficiente per selezione.  <span>PT</span> Tempo Restantes. Carga da bateria insuficiente para seleção.                 </p>
 / 		<p> <span>EN</span> Overcurrent.  <span>FR</span> Surcharge.  <span>DE</span> Überlastung.  <span>ES</span> Sobrecarga.  <span>IT</span> Sovraccarico.  <span>PT</span> Sobrecarga.                 </p>



2s

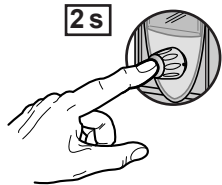

- EN Press for 2 s to enter the settings menu or the Service menu
- FR Pousser 2 s pour entrer dans le menu paramètre ou le menu Service
- DE 2 s drücken, um das Menü Parameter oder das Menü Service zu öffnen
- ES Pulsar 2 s para entrar en el menú parámetro o el menú Servicio
- IT Premere per 2 s per entrare nel menu Settaggi o nel menu Manutenzione
- PT Premir 2 s para entrar no menu de ajuste ou no menu serviço



- EN Turn to scroll through the menus and values
- FR Tourner pour faire défiler les menus et les valeurs
- DE Drehen, um die Menüs und Werte zu durchlaufen
- ES Girar para hacer desfilir los menús y valores
- IT Girare per far scorrere i menu e i valori
- PT Girar para fazer desfilir os menus e os valores



- EN Settings
- FR Réglage
- DE Einstell.
- ES Configuración
- IT Settaggi
- PT Ajuste

IN 23.9V  
OK

SETTINGS

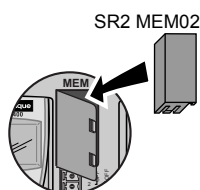

MEM →  
?

- EN Download from memory /
- FR Charger une configuration /
- DE Konfiguration laden /
- ES Cargar una configuración /
- IT Carica una configurazione /
- PT Carregar uma configuração

LANG.  
english ?

- EN Settings language
- FR Choix de la langue
- DE Sprachenauswahl
- ES Seleccionar el idioma
- IT Scelta della lingua
- PT Escolha da língua

7.0Ahx1?

- EN Battery selection
- FR Choix de la batterie
- DE Batterieauswahl
- ES Seleccionar la batería
- IT Scelta della batteria
- PT Escolha da bateria

00:10:00s ?

- EN Setting the buffering time
- FR Réglage du temps de sauvegarde
- DE Einstellung der Speicherzeit
- ES Ajuste del tiempo de guardado
- IT Regolazione del tempo di back-up
- PT Regulação do tempo de guarda

IN →  
21V

- EN Cut-in threshold (non modifiable)
- FR tension d'activation de la batterie (non modifiable)
- DE Einstellung der Aktivierungsspannung der Batterie (kann nicht geändert werden)
- ES tensión de activación de la batería (no modificable)
- IT Impostazione tensione di attivazione della batteria
- PT Tensão de ativação da bateria (não modificável)

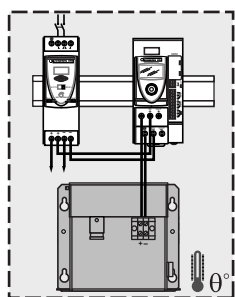

L  
2.0m ?

- EN Cable length between ABL 8BPK and ABL 8BBU
- FR Longueur de câble entre ABL 8BPK et ABL 8BBU
- DE Länge des Kabels zwischen ABL 8BPK und ABL 8BBU
- ES Longitud del cable entre ABL 8BPK y ABL 8BBU
- IT Lunghezza del cavo tra ABL 8BPK e ABL 8BBU
- PT Comprimento do cabo entre ABL 8BPK e ABL 8BBU

T<sub>bat.</sub> = 25°C

- EN Setting the battery ambient temperature in operation
- FR Réglage de la température ambiante de la batterie en fonctionnement
- DE Einstellung der Umgebungstemperatur der in Betrieb gesetzten Batterie
- ES Ajuste de la temperatura ambiente de la batería en funcionamiento
- IT Regolazione della temperatura ambiente della batteria in funzionamento
- PT Regulação da temperatura ambiente da bateria em funcionamento

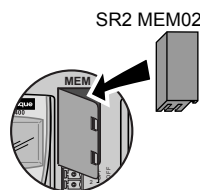

MEM  
?

- EN Upload to memory
- FR Sauvegarder une configuration
- DE Konfiguration speichern
- ES Guardar una configuración
- IT Salva una configurazione
- PT Guardar uma configuração

EXIT

1 s

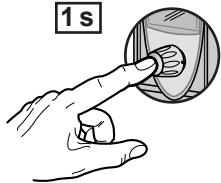

- (EN) Press for 1 s to select a submenu or value.
- (FR) Pousser 1 s pour sélectionner un sous menu ou une valeur.
- (DE) 1 s drücken, um ein Untermenü oder einen Wert auszuwählen.
- (ES) Pulsar 1s para seleccionar un submenú o valor.
- (IT) Premere per 1 s per selezionare un sotto-menu o un valore
- (PT) Premir 1 s para seleccionar um submenu ou um valor.

(EN) Service (FR) Service (DE) Service (ES) Servicio (IT) Servizio (PT) Service

SERVICE

off?

TEST ?

TEST ?

Active?

Deactiv.?

New Init?

SETT. Init?

PC→SW ?

Version ?

EXIT

- (EN) Battery ON/OFF
- (FR) Activation de la batterie ON/OFF
- (DE) Batterie EIN/AUS
- (ES) Activación de la batería ON/OFF
- (IT) Attivazione ON/OFF della batteria
- (PT) Ativação da bateria ON/OFF

- (EN) Perform battery test
- (FR) Tester la batterie
- (DE) Batterie testen
- (ES) Probar la batería
- (IT) Eseguire il test della batteria
- (PT) Testar a bateria

- (EN) Perform display test
- (FR) Tester l'écran
- (DE) Display testen
- (ES) Probar la pantalla
- (IT) Eseguire il test dello schermo
- (PT) Testar o ecrã

- (EN) Charging rate test for battery
- (FR) Activation/désactivation du test de charge de la batterie
- (DE) Aktivierung/Deaktivierung des Batterieladetests
- (ES) Prueba de velocidad de carga de la batería
- (IT) Attivazione/disattivazione del test di carica della batteria
- (PT) Ativação/desactivação do teste de carga da bateria

- (EN) Aging test for battery
- (FR) Activation/désactivation du test de vieillissement de la batterie
- (DE) Aktivierung/Deaktivierung des Batteriealterstests
- (ES) Prueba de envejecimiento de la batería
- (IT) Attivazione/disattivazione del test di età della batteria
- (PT) Ativação/desactivação do teste de idade da bateria

- (EN) ABL 8BPK reset
- (FR) Réinitialisation de ABL 8BPK
- (DE) Reinitialisierung von ABL 8BPK
- (ES) Reincialización de ABL 8BPK
- (IT) Reinizializzazione di ABL 8BPK
- (PT) Reincialização de ABL 8BPK

- (EN) ABL 8BBU reset
- (FR) Réinitialisation de ABL 8BBU
- (DE) Reinitialisierung von ABL 8BBU
- (ES) Reincialización de ABL 8BBU
- (IT) Reinizializzazione di ABL 8BBU
- (PT) Reincialização de ABL 8BBU

- (EN) Updating resident software
- (FR) Mise à jour du logiciel embarqué
- (DE) Aktualisierung der integrierten Software
- (ES) Actualización del software residente
- (IT) Aggiornamento del software di bordo
- (PT) Atualização do software embarcado

- (EN) Resident software version number
- (FR) Numéro de version du logiciel embarqué
- (DE) Versionsnummer der integrierten Software
- (ES) Número de versión del software residente
- (IT) Versione del software di bordo
- (PT) Número de versão do software embarcado

- (EN) Checksum of the settings loaded
- (FR) Checksum des paramètres chargés
- (DE) Checksum der geladenen Einstellungen
- (ES) Checksum de los parámetros cargados
- (IT) Checksum dei parametri caricati
- (PT) Checksum dos parâmetros carregados

Version  
Soft Vers

Version  
Sett. Chk.

Version  
esc

- (EN) Setting the battery temperature      (FR) Réglage de température de la batterie      (DE) Temperatureinstellung der Batterie  
 (ES) Ajuste de la temperatura de la batería      (IT) Regolazione della temperatura della batteria      (PT) Regulação da temperatura da bateria

**A**

- (EN) Installing the battery in the cabinet ☺  
 (FR) Montage de la batterie en armoire ☺  
 (DE) Batteriemontage im Schrank ☺  
 (ES) Montaje de la batería en el armario ☺  
 (IT) Montaggio della batteria all'interno dell'armadio ☺  
 (PT) Montagem da bateria no armário ☺

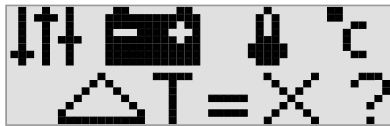
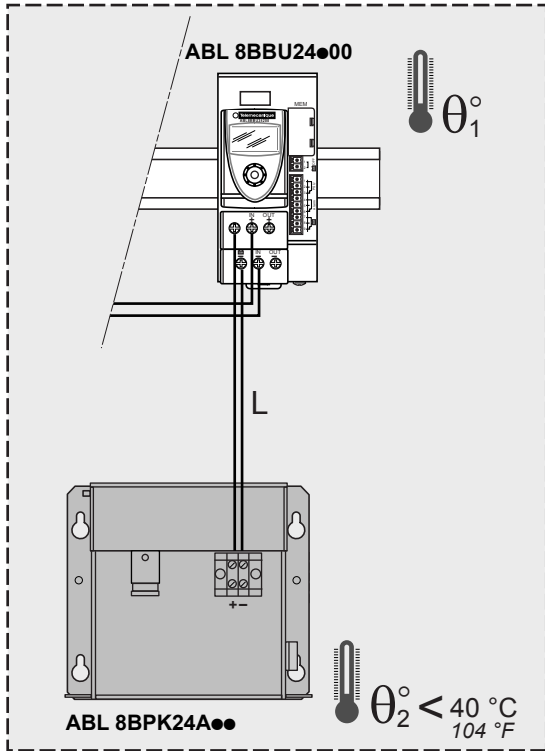

$$X = \theta_1 - \theta_2$$

**B**

- (EN) Installing the battery outside the cabinet ☹  
 (FR) Montage de la batterie à l'extérieur de l'armoire ☹  
 (DE) Batteriemontage außerhalb des Schrankes ☹  
 (ES) Montaje de la batería fuera del armario ☹  
 (IT) Montaggio della batteria all'esterno dell'armadio ☹  
 (PT) Montagem da bateria fora do armário ☹

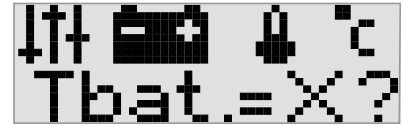
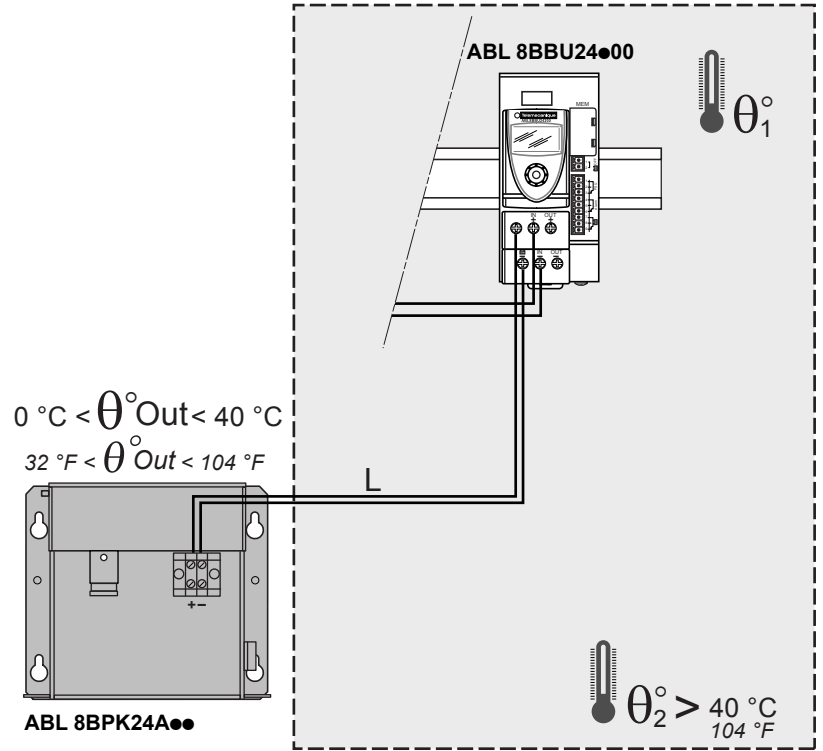

$$X = \theta^{\circ} \text{Out}$$

- (EN) Precautions for stop  $\geq 3$  days      (ES) Precauciones para parada  $\geq 3$  días  
 (FR) Précautions sur arrêt  $\geq 3$  jours      (IT) Precauzioni in caso di arresto  $\geq 3$  giorni  
 (DE) Vorsichtsmaßnahmen bei      (PT) Precauções para paragem  $\geq 3$  dias  
 Außerbetriebsetzung  $\geq 3$  Tage

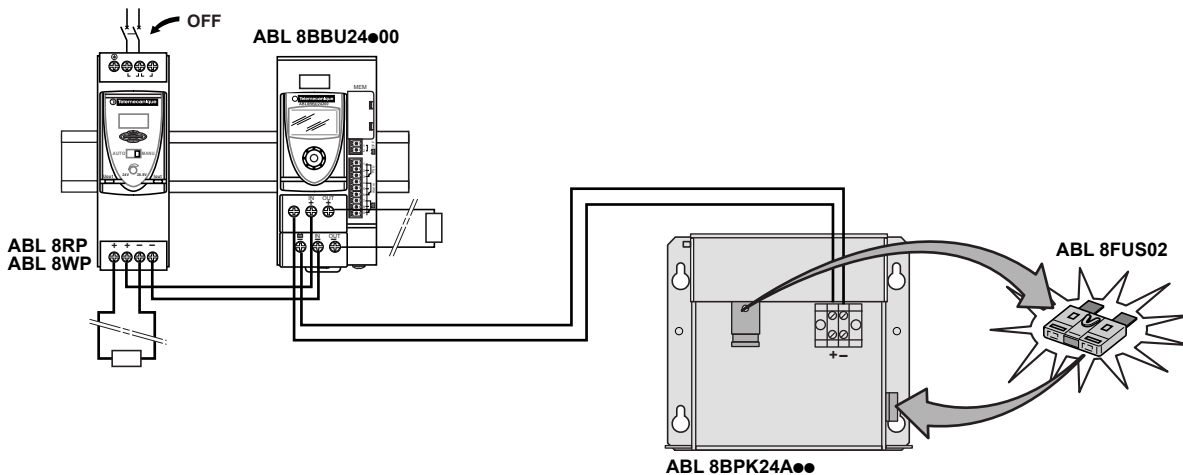

- (EN) In the event of a prolonged, voluntary stop, check that the battery is fully charged (green screen OK)  
 (FR) En cas d'arrêt prolongé volontaire, vérifier que la batterie est complètement chargée (écran vert OK)  
 (DE) Bei längerer Außerbetriebsetzung überprüfen, ob die Batterie vollkommen geladen ist (grüner Bildschirm OK)  
 (ES) En caso de parada prolongada voluntaria, comprobar que la batería está completamente cargada (pantalla verde OK)  
 (IT) In caso di arresto prolungato volontario, verificare che la batteria sia completamente carica (schermo verde OK)  
 (PT) Em caso de paragem prolongada voluntária, verificar que a bateria está completamente carregada (ecrã verde OK)