

FLUKE®

810

Vibration Tester

Users Manual

January 2010, Rev. 2, 5/15

© 2010-2015 Fluke Corporation. All rights reserved. Specifications are subject to change without notice.
All product names are trademarks of their respective companies.

LIMITED WARRANTY AND LIMITATION OF LIABILITY

Your Fluke Vibration Tester is warranted to be free from defects in material and workmanship under normal use and service for three years from the date of shipment to you. The same warranty applies to the Tachometer and the Sensor but for one year from the date of shipment. Parts, product repairs, and services are warranted for 90 days. This warranty extends only to the original buyer or end-user customer of a Fluke authorized reseller, and does not apply to fuses, disposable batteries, or to any product which, in Fluke's opinion, has been misused, altered, neglected, contaminated, or damaged by accident or abnormal conditions of operation or handling. Fluke warrants that software will operate substantially in accordance with its functional specifications for 90 days and that it has been properly recorded on non-defective media. Fluke does not warrant that software will be error free or operate without interruption.

Fluke authorized resellers shall extend this warranty on new and unused products to end-user customers only but have no authority to extend a greater or different warranty on behalf of Fluke. Warranty support is available only if product is purchased through a Fluke authorized sales outlet or Buyer has paid the applicable international price. Fluke reserves the right to invoice Buyer for importation costs of repair/replacement parts when product purchased in one country is submitted for repair in another country.

Fluke's warranty obligation is limited, at Fluke's option, to refund of the purchase price, free of charge repair, or replacement of a defective product which is returned to a Fluke authorized service center within the warranty period.

To obtain warranty service, contact your nearest Fluke authorized service center to obtain return authorization information, then send the product to that service center, with a description of the difficulty, postage and insurance prepaid (FOB Destination). Fluke assumes no risk for damage in transit. Following warranty repair, the product will be returned to Buyer, transportation prepaid (FOB Destination). If Fluke determines that failure was caused by neglect, misuse, contamination, alteration, accident, or abnormal condition of operation or handling, including overvoltage failures caused by use outside the product's specified rating, or normal wear and tear of mechanical components, Fluke will provide an estimate of repair costs and obtain authorization before commencing the work. Following repair, the product will be returned to the Buyer transportation prepaid and the Buyer will be billed for the repair and return transportation charges (FOB Shipping Point).

THIS WARRANTY IS BUYER'S SOLE AND EXCLUSIVE REMEDY AND IS IN LIEU OF ALL OTHER WARRANTIES, EXPRESS OR IMPLIED, INCLUDING BUT NOT LIMITED TO ANY IMPLIED WARRANTY OF MERCHANTABILITY OR FITNESS FOR A PARTICULAR PURPOSE. FLUKE SHALL NOT BE LIABLE FOR ANY SPECIAL, INDIRECT, INCIDENTAL OR CONSEQUENTIAL DAMAGES OR LOSSES, INCLUDING LOSS OF DATA, ARISING FROM ANY CAUSE OR THEORY.

Since some countries or states do not allow limitation of the term of an implied warranty, or exclusion or limitation of incidental or consequential damages, the limitations and exclusions of this warranty may not apply to every buyer. If any provision of this Warranty is held invalid or unenforceable by a court or other decision-maker of competent jurisdiction, such holding will not affect the validity or enforceability of any other provision.

Fluke Corporation
P.O. Box 9090
Everett, WA 98206-9090
U.S.A.

Fluke Europe B.V.
P.O. Box 1186
5602 BD Eindhoven
The Netherlands

Table of Contents

Chapter	Title	Page
1	Overview	1-1
	Introduction	1-3
	Features	1-3
	How to Contact Fluke	1-4
	Safety	1-4
	Rotating Equipment	1-5
	Tachometer	1-5
	Heat Sink	1-6
	Symbols	1-6
	Unpack and Inspect	1-7
	Storage	1-9
	Battery	1-9
	Accessories	1-11

2	Specifications	2-1
	Vibration Tester Specifications	2-3
	Diagnostic Specifications	2-3
	Electrical Specifications	2-3
	General Specifications	2-4
	Sensor Specifications	2-5
	Tachometer Specifications	2-6
	Viewer Software Requirements	2-7
3	Getting Started.....	3-1
	Introduction.....	3-3
	Navigation and User Interface	3-3
	How to Use the Dial	3-5
	How to Use the Function Softkeys	3-5
	Accessory Connectors.....	3-6
	Start the Tester	3-7
	Sensor Setup.....	3-7
	Compatible Sensors.....	3-7
	How to Connect the Fluke Sensor	3-8
	Sensor Care and Handling.....	3-9
	Tachometer Setup.....	3-9
	How to Measure RPM with the Tachometer	3-9
	Laser Safety Precautions.....	3-10
	How to Access Help.....	3-11
	Instrument Setup	3-11
	Self Test.....	3-11
	Settings.....	3-12
	Clear Memory	3-14

4	Operation	4-1
	Start the Tester	4-3
	Create a New Machine Setup	4-3
	Machine Setup	4-4
	Motor Input (Driver) Information.....	4-5
	RPM Entry	4-7
	Coupling Information	4-7
	Transmission with Closed Coupling.....	4-8
	Transmission without Closed Coupling.....	4-9
	Driven Component.....	4-10
	Pump	4-10
	Fan	4-11
	Compressor	4-12
	Blower.....	4-13
	Spindle.....	4-13
	Transmission Component.....	4-13
	Gearbox.....	4-13
	Belt Drive	4-16
	Copy an Existing Machine Setup.....	4-18
	Edit the Saved Machine Setup	4-19
	Before You Measure	4-20
	Select Measurement Locations	4-20
	Total Number of Measurement Locations.....	4-21
	Sensor Orientation.....	4-22
	Sensor Mounting	4-23
	How to Measure Vibration	4-25
	How to Diagnose.....	4-32
	Fault Types.....	4-32

	Overall Vibration	4-33
	Severity Scale	4-34
	Fault Details and Vibration Spectrum	4-35
	How to Access the Memory	4-38
	View by Machine Setup	4-39
	View by Measurement Date	4-39
	View by Last Diagnosis	4-40
5	Viewer Software	5-1
	Introduction	5-3
	System Requirements	5-3
	PC Connections	5-3
	Install the Viewer Software	5-5
	Uninstall the Viewer Software	5-5
	Navigation	5-6
	Preferences	5-9
	Application Settings	5-10
	Upgrades	5-11
	Data Transfer	5-11
	Import Machine Setup	5-13
	Export Machine Setup	5-15
	Import Diagnostic Data	5-17
	Export Diagnostic Data	5-19
	Export Faults Data	5-21
	Machine Setup	5-25
	Set Up a New Machine	5-25
	View Machine Setups	5-26
	View Diagnosis	5-29
	View Other Data Files	5-33

	Time Waveform	5-34
	Spectra	5-35
6	Maintenance	6-1
	Introduction	6-3
	How to Clean.....	6-3
	Sensor Care	6-3
	Battery Replacement.....	6-3
	Vibration Tester Upgrades	6-5
	How to Troubleshoot	6-6
	Appendices	
	A Frequently Asked Questions	A-1
	B Warning and Error Messages	B-1
	C Glossary.....	C-1

List of Tables

Table	Title	Page
1-1.	Symbols.....	1-6
1-2.	Accessories.....	1-11
3-1.	Front Panel.....	3-4
3-2.	Navigation Softkey Functions.....	3-5
3-3.	Accessory Connectors.....	3-6
3-4.	Tester Settings.....	3-12
4-1.	New Machine Setup Functions.....	4-4
4-2.	Motor Input Options.....	4-6
4-3.	Closed Coupling Transmission Options.....	4-8
4-4.	Transmission without Closed Coupling Options.....	4-9
4-5.	Pump Options for Driven Components.....	4-10
4-6.	Fan Options for Driven Components.....	4-11
4-7.	Compressor Options for Driven Components.....	4-12
4-8.	Blower Options for Driven Components.....	4-13

4-9. Gearbox Options for the Transmission	4-14
4-10. Driven Component Options.....	4-15
4-11. Drive Options for the Transmission.....	4-16
4-12. Change Machine Name	4-17
4-13. Saved Machine Setup Functions	4-17
4-14. Copy Machine Setup Functions	4-18
4-15. Change Machine Name Functions.....	4-19
4-16. Sensor Placement Functions	4-27
4-17. Measurement Functions	4-29
4-18. Measurement Complete Functions	4-30
4-19. Sensor Placement Functions	4-31
4-20. Diagnosis Faults	4-33
4-21. Cited Peak Details	4-37
4-22. Diagnosis Spectra Functions	4-38
4-23. Existing Machine Setup Functions	4-39
4-24. Measurement Date Functions.....	4-39
4-25. View by Measurement Date Functions	4-40
5-1. Viewer Software Navigation Menus	5-7
5-2. Application Settings	5-10
5-3. View Machine Setup Utilities.....	5-28
6-1. Troubleshooting	6-6

List of Figures

Figure	Title	Page
1-1.	Items Included with the Tester.....	1-8
1-2.	How to Charge the Battery	1-10
3-1.	Front Panel.....	3-3
3-2.	Accessory Connectors	3-6
3-3.	Sensor Setup and Connection.....	3-8
3-4.	Tachometer Setup and Connection.....	3-10
4-1.	Sensor Location	4-21
4-2.	Axes Orientation	4-22
4-3.	Sensor Mounting Options	4-23
5-1.	Tester to PC Connections	5-4
6-1.	Battery Replacement.....	6-4

Chapter 1 Overview

Title	Page
Introduction	1-3
Features	1-3
How to Contact Fluke	1-4
Safety	1-4
Rotating Equipment	1-5
Tachometer	1-5
Heat Sink	1-6
Symbols	1-6
Unpack and Inspect.....	1-7
Storage.....	1-9
Battery.....	1-9
Accessories.....	1-11

Introduction

The Fluke 810 Vibration Tester with diagnostic technology (the Tester) helps you quickly identify and prioritize mechanical problems. With the Tester, you can make decisions about mechanical maintenance and use it as a supplement to your own judgment based on machine knowledge. The expertise of a trained vibration analyst is in your hands.

The Tester uses a simple step-by-step process to report on machine faults the first time measurements are taken without prior measurement history. The diagnostic technology analyzes your machinery and provides text-based diagnoses, severity levels and possible repair recommendations. Faults are identified by comparing vibration data gathered by the Tester to an extensive set of rules gathered over years of field experience.

Primarily used for troubleshooting problem equipment, the Tester can also be used to survey equipment before or after planned maintenance. The combination of diagnoses, severity and possible repair recommendations help you make more informed maintenance decisions and address critical problems first.

Training is important to the success of vibration testing, even for experienced vibration experts. The Training DVD included with the Tester contains Getting Started Videos. Fluke recommends you take the self-paced training program on the Fluke website, www.fluke.com. The site also has additional training programs, guides, and videos.

Warning

Read “Safety Information” before using this Tester.

Features

- On-board diagnosis and location of the four most common standard mechanical faults: bearings, looseness, misalignment, unbalance and other (non-standard faults)
- Fault severity scale with four severity levels: Slight, Moderate, Serious, and Extreme
- Prioritized repair recommendations
- Diagnostic details include cited peaks and vibration spectra
- Detects overall vibration levels

- Context Sensitive Help
- 4 GB on-board memory
- Data export (via USB connection) for more detailed analysis
- Self-test function
- Laser tachometer for accurate machine running speed
- 100 mV/g TEDS triaxial accelerometer
- Data storage and tracking with included Viewer Software
- Color LCD display
- Languages: English, French, German, Italian, Portuguese, Spanish, Japanese, Simplified Chinese, Russian, Turkish

How to Contact Fluke

To contact Fluke, call one of the following telephone numbers:

Technical Support USA: 1-800-44-FLUKE
(1-800-44-5853)

Calibration/Repair USA: 1-888-99-FLUKE
(1-888-993-5853)

Canada: 1-800-36-FLUKE (1-800-363-5853)

Europe: +31 402-675-200

Japan: +81-3-6714-3114

Singapore: +65-738-5655

Anywhere in the world: +1-425-446-5500

Or, visit Fluke's website at www.fluke.com.

To register your product, visit <http://register.fluke.com>.

To view, print, or download the latest manual supplement, visit <http://us.fluke.com/usen/support/manuals>.

Safety

In this manual, a **Warning** identifies hazardous conditions and actions that could cause bodily harm or death. A **Caution** identifies conditions and actions that could damage the Tester, the equipment under test, or cause permanent loss of data.

⚠ Warning

To avoid personal injury, follow these guidelines for the Tester:

- Use only as specified in this manual or the protection provided by the Tester might be impaired.
- Do not use if damaged. Before you use the Tester, inspect the case. Look for cracks or missing plastic.
- Make sure the battery is securely in place before operation.
- Do not operate around explosive gas, vapor, or dust.
- Use proper protective equipment, as required by local or national authorities, when working in hazardous areas.
- Comply with local and national safety requirements when working in hazardous locations.

Rotating Equipment

⚠ Warning

To avoid personal injury:

- Use caution around rotating equipment.
- Keep cords and straps contained.

Tachometer

⚠⚠ Warning

To avoid personal injury or damage to the Tachometer:

- Do not point laser beam directly at eyes.
- Do not operate around explosive gas, vapor or dust.
- Do not open. The Tachometer does not contain any user-serviceable parts.
- When not in use, always place in protective cover.

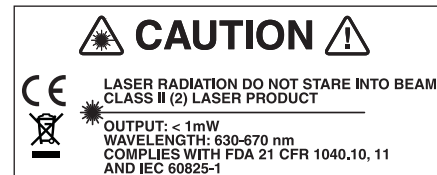

Heat Sink

 **Caution**

- The heat sink may feel warm to the touch, this is normal.
- To avoid overheating, do not cover the heat sink while the Tester is on.

Symbols

Table 1-1 lists and describes the symbols used on the Tester and in this manual.

For radio frequency certification, see www.fluke.com.

Table 1-1. Symbols









Symbol	Description
	Important Information; refer to manual
	Battery condition
 Li-ion	This product contains a Lithium-ion battery. Do not mix with the solid waste stream. Spent batteries should be disposed of by a qualified recycler or hazardous materials handler per local regulations. Contact your authorized Fluke Service Center for recycling information.

Table 1-1. Symbols (cont.)

Symbol	Description
	Certified by CSA Group to North American safety standards.
	Conforms to relevant Australian EMC standards.
	Conforms to European Union directives.
	Warning. Class 2 Laser Product. Laser radiation. Do not stare into beam.
	This product complies with the WEEE Directive marking requirements. The affixed label indicates that you must not discard this electrical/electronic product in domestic household waste. Product Category: With reference to the equipment types in the WEEE Directive Annex I, this product is classed as category 9 "Monitoring and Control Instrumentation" product. Do not dispose of this product as unsorted municipal waste.
	Conforms to relevant South Korean EMC Standards.

Unpack and Inspect

Carefully unpack and inspect all the items in Figure 1-1. The items that follow are included in your purchase of the Tester:

- ① Vibration Tester
- ② Storage Case
- ③ Smart Battery Pack
- ④ Smart Battery Pack Charger and Adapters
- ⑤ Shoulder Strap
- ⑥ Tachometer and Pouch
- ⑦ Sensor
- ⑧ Sensor Magnet Mount
- ⑨ Sensor Quick Disconnect Cable
- ⑩ Sensor Mounting Pads (10-pack)
- ⑪ Adhesive
- ⑫ Mini USB to USB Cable
- ⑬ Quick Reference Guide
- ⑭ User Documentation / Viewer Software CD-ROM
- ⑮ Training DVD

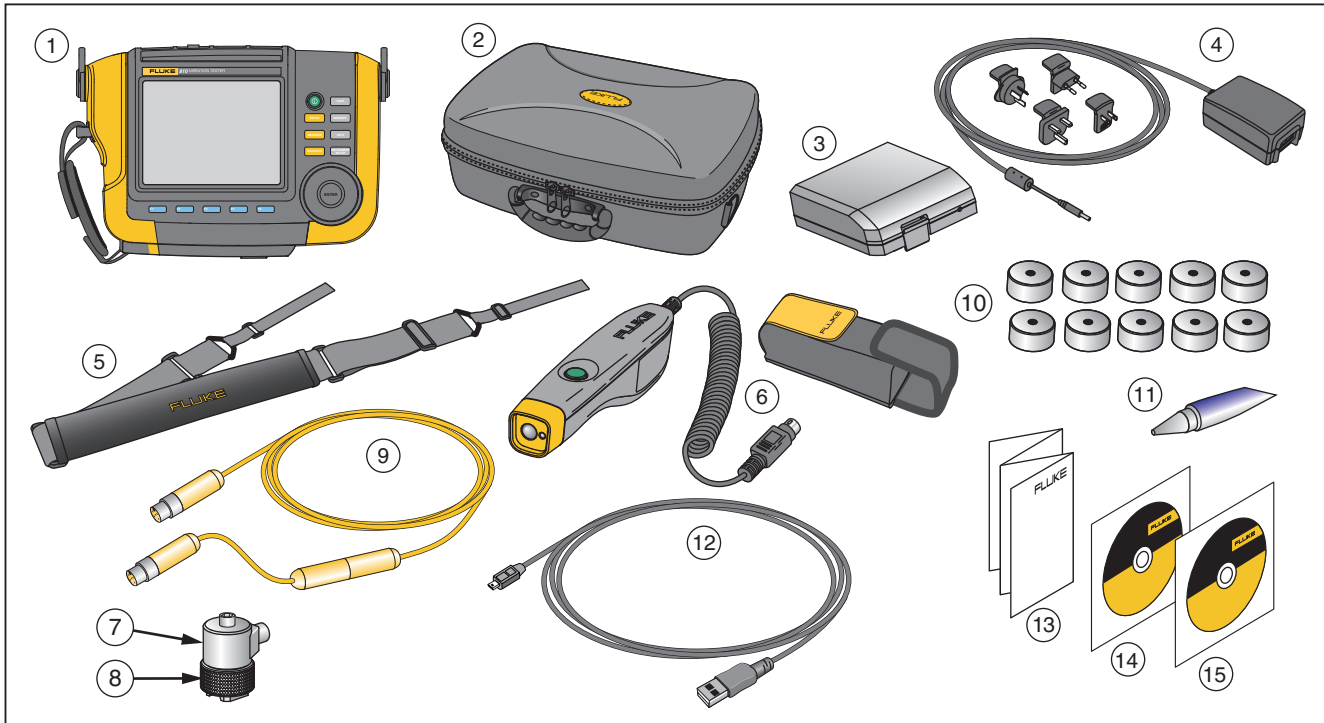

Figure 1-1. Items Included with the Tester

gbk10.eps

Storage

When not in use, keep the Tester in the protective storage case. The case has sufficient space for the Tester and all accessories.

Battery

The Tester operates on an internal rechargeable Lithium-ion battery. After you unpack and inspect the Tester, fully charge the battery before the first use. Afterwards, charge the battery when the battery icon on the screen indicates that power is low. To charge the battery with the battery in place on the Tester:

1. Connect the ac adapter to the ac input socket of the battery.
2. Connect the adapter to a power source.

Or, to charge the battery outside the Tester:

1. Remove the battery from the Tester, see Figure 1-2.
2. Connect the ac adapter to the ac input socket of the battery.
3. Connect the adapter to a power source.

Note

Three hours are necessary for a full battery charge.

The color of the battery status LED shows:

Red - battery is connected to the power source and charging.

Green - battery is connected to the power source and is fully charged.

Caution

To prevent damage to the Tester:

- **Use only the ac adapter that is included with the Tester.**
- **Make sure that the external power source is correctly rated for the Tester.**
- **Do not leave batteries unused for extended periods of time, either in the product or in storage.**
- **When a battery has not been used for six months, check the charge status and charge or dispose of the battery as appropriate.**

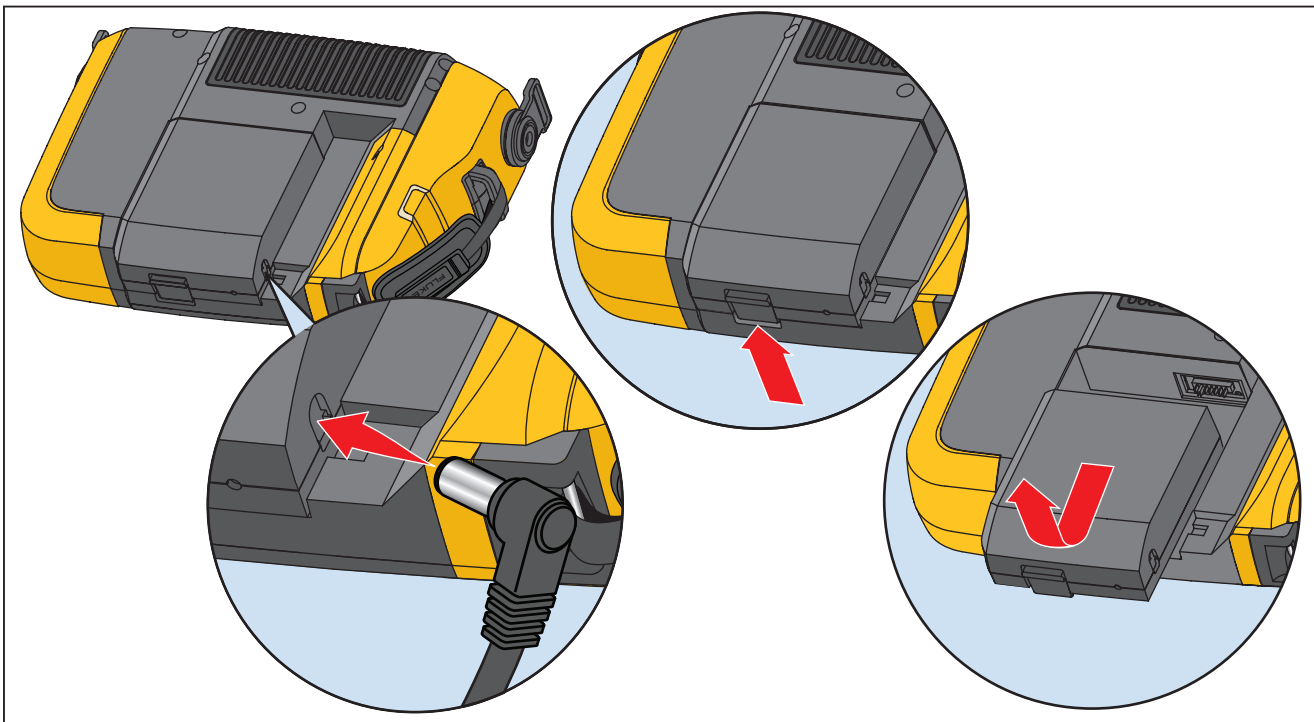

gbk03.eps

Figure 1-2. How to Charge the Battery

Accessories

Table 1-2 lists the accessories that are available and sold separately for the Tester.

Table 1-2. Accessories

Model	Description	Part Number
810T	Tachometer	3530819
810S	Sensor	3530828
810QDC	Quick Disconnect Cable	3530837
SBP810	Smart Battery Pack	3530843
810SMM	Sensor Magnet Mount	3530862
810SMP	Sensor Mounting Pads	3530855

Note

The maximum cable run is 20 ft (6 m). Do not combine cables to exceed the maximum cable run or you may get unexpected results.

Chapter 2

Specifications

Title	Page
Vibration Tester Specifications	2-3
Diagnostic Specifications	2-3
Electrical Specifications	2-3
General Specifications	2-4
Sensor Specifications	2-5
Tachometer Specifications	2-6
Viewer Software Requirements	2-7

Vibration Tester Specifications

Specifications are subject to change without notice.

Diagnostic Specifications

Standard Fault Detection	Unbalance, Looseness, Misalignment and Bearing Failures
Analysis for	Motors, Fans, Blowers, Belts and Chain Drives, Gearboxes, Couplings, Centrifugal Pumps, Piston Pumps, Sliding Vane Pumps, Propeller Pumps, Screw Pumps, Rotary Thread/Gear/Lobe Pumps, Piston Compressors, Centrifugal Compressors, Screw Compressors, Closed Coupled Machines, Spindles
Motor Rotational Speed Range	200 RPM to 12,000 RPM
Diagnosis Details	Fault Severity (Slight, Moderate, Serious, Extreme), Repair Details, Cited Peaks, Spectra

Electrical Specifications

Ranging	Automatic
A/D Converter	4 channel, 24 bit
Usable Bandwidth	5 Hz to 20 kHz
Digital Signal Processing Functions	Automatically-configured anti-alias filter, High-pass filter, Decimation, Overlapping, Windowing, FFT and Averaging
Sampling Rate	2.56 kHz to 51.2 kHz
Dynamic Range	128 dB
Signal-to-Noise Ratio	100 dB
FFT Resolution800
Spectral Windows	Hanning
Frequency Units	Hz, orders, cpm
Amplitude Units	in/sec, mm/sec, VdB (US), VdB* (Europe)
Non-Volatile Memory	SD micro memory card, 4 GB internal

General Specifications

Size	7.30 in × 2.76 in × 10.52 in (18.56 cm x 7.00 cm x 26.72 cm)
Weight (with battery)	4.2 lbs (1.9 kg)
Display	¼ VGA, 320 × 240 Color (5.7 inch diagonal) TFT LCD with LED backlight

Input/Output Connections

Triaxial sensor connection	4 pin M12 Connector
Single axis sensor connection	BNC Connector
Tachometer connection	Mini DIN 6 pin Connector
PC connection.....	Mini 'B' USB (2.0) Connector

Battery

Battery type.....	Lithium-ion, 14.8 V, 2.55 Ah
Battery charging time	3 hr
Battery discharge time	8 hr (under normal conditions)

AC Adapter

Input voltage	100 Vac to 240 Vac
Input frequency	50/60 Hz

Operating System

WinCE 6.0 Core

Operating Temperature

32 °F to 122 °F (0 °C to 50 °C)

Storage Temperature.....

-4 °F to 140 °F (-20 °C to 60 °C)

Operating Humidity.....

10 % to 90 % RH (non-condensing)

Altitude.....

2000 m

Ingress Protection Rating

IP54

Safety

IEC 61010-1, Pollution degree 2
IEC 60825-1, Class 2
IEC 62133, Lithium battery pack

Electromagnetic Compatibility

InternationalIEC 61326-1: Portable; CISPR 11: Group 1, Class A

Group 1: Equipment has intentionally generated and/or uses conductively-coupled radio frequency energy that is necessary for the internal function of the equipment itself.

Class A: Equipment is suitable for use in all establishments other than domestic and those directly connected to a low-voltage power supply network that supplies buildings used for domestic purposes.

FCC47 CFR 15 subpart B. This product is considered an exempt device per clause 15.103.

Korea (KCC).....Class A Equipment (Industrial Broadcasting & Communication Equipment)

Class A: Equipment meets requirements for industrial electromagnetic wave equipment and the seller or user should take notice of it. This equipment is intended for use in business environments and not to be used in homes.

Recommended Calibration Interval2 years

Sensor Specifications

Sensor TypeAccelerometer

Sensitivity, ±5 %, 25 °C100 mV/g

Acceleration Range80 g peak

Amplitude Nonlinearity1 %

Frequency Response

Z, ±3 dB2 - 7,000 Hz

X, Y, ±3 dB2 - 5,000 Hz

Power Requirement (IEPE)18-30 VDC, 2-10 mA

Bias Output Voltage12 VDC

GroundingCase grounded

Sensing Element DesignPZT ceramic / shear

Case Material	316L stainless steel
Mounting	10-32 capacitive socket head screw, 2-pole rare earth magnet (48 lb pull strength)
Output Connector	4-Pin, M12
Mating Connector	M12 - F4D
Non-Volatile Memory	TEDS 1451.4 compatible
Vibration Limit	500 g peak
Shock Limit	5000 g peak
Electromagnetic Sensitivity, Equivalent g	100 µg/gauss
Sealing	Hermetic
Temperature Range	-58 °F to 248 °F (-50 °C to 120 °C) ±7 %

Tachometer Specifications

Dimensions	1.125 in x 4.80 in (2.86 cm x 12.19 cm)
Weight	3.4 oz (96 gr) with cable
Power	Powered by Vibration Tester
Detection	Laser Diode Class 2
Range	6.0 to 99,999 RPM
Accuracy	
6.0 to 5999.9 RPM	±0.01 % and ±1 digit
5999.9 to 99999 RPM	±0.05 % and ±1 digit
Resolution	0.1 RPM
Effective Range	0.4 in to 39.27 in (1 cm to 100 cm)
Response Time	1 second (>60 RPM)
Controls	Measure on/off transparent button

Interface	6 Pin Mini DIN
Cable Length	19.586 in (50 cm)
Tachometer Accessories	
Reflective tape	0.59 in × 20.67 in (1.5 cm x 52.5 cm)
<i>Viewer Software Requirements</i>	
Minimum Hardware	1 GB RAM
Operating System	Windows XP, Vista, Windows 7, Windows 8.1

Chapter 3

Getting Started

Title	Page
Introduction	3-3
Navigation and User Interface.....	3-3
How to Use the Dial.....	3-5
How to Use the Function Softkeys.....	3-5
Accessory Connectors	3-6
Start the Tester	3-7
Sensor Setup	3-7
Compatible Sensors	3-7
How to Connect the Fluke Sensor	3-8
Sensor Care and Handling	3-9
Tachometer Setup.....	3-9
How to Measure RPM with the Tachometer	3-9
Laser Safety Precautions	3-10
How to Access Help	3-11
Instrument Setup.....	3-11
Self Test	3-11
Settings	3-12
Clear Memory.....	3-14

Introduction

This chapter helps you to understand and become familiar with the user interface, connections, and accessories.

Navigation and User Interface

Figure 3-1 shows the front panel of the Vibration Tester. Table 3-1 lists the front-panel controls and their functions.



gbk02.eps

Figure 3-1. Front Panel

Table 3-1. Front Panel

Item	Control	Description
①	①	Turns the Tester on or off.
②	SETUP	Shows the Machine Setup options: Set up new Machine, Copy Machine Setup, Change a Machine Setup
③	MEASURE	Shows the Machine Setups available for measurement. After the selection of a Machine Setup, continue with the measurement screens.
④	DIAGNOSE	Shows the completed Machine Setups with measurements that are available for diagnosis. After a measurement, push to see the diagnosis screen.
⑤	SAVE	Saves the parameters for the Tester settings and Machine Setups.

Table 3-1. Front Panel (cont.)

Item	Control	Description
⑥	MEMORY	Shows the Machine Setups and diagnoses in Tester memory.
⑦	INFO	From the Startup screen, shows the Help menu. For other screens, shows Help for the current screen.
⑧	INSTRUMENT SETUP	Shows the Self Test, Settings, and Clear Memory functions.
⑨	Dial	Turn the Dial to move the cursor highlight on the screen. Push the center of the Dial (Enter) to make the selection.
⑩	Softkeys	Softkeys (F1) through (F5) make the selections that show on the screen above each softkey.

How to Use the Dial

The Dial has multiple functions. Turn the Dial clockwise or counterclockwise to move the cursor or highlight. Push the Dial to make a selection.

How to Use the Function Softkeys

Along the bottom of the display, a row of labels shows the available functions. Push a softkey, **F1** through **F5**, below the display label to start that function.

Table 3-2 lists the navigation softkeys and their function.

Note

When the beeper is on, a short beep sounds for a valid button push. A long beep sounds for an invalid button push.

Table 3-2. Navigation Softkey Functions

Softkey	Function
Previous Page / Next Page	View the previous/next screen.
Enter	Select the highlighted function. Or, push the Dial to select the same function.
Back	Go to the previous field or screen.
Move Cursor	Move the cursor one space to the left.
Delete Character	Delete a character.
Exit	Exit from current display.
Save	Save settings in current display.
Done	Save keyboard entries.

Also, you can use the front-panel buttons, along the right side of the Tester, to go directly to a top-level menu.

Accessory Connectors

Figure 3-2 shows the connector panel of the Tester. Table 3-3 is a list of descriptions for each connector on the Tester.

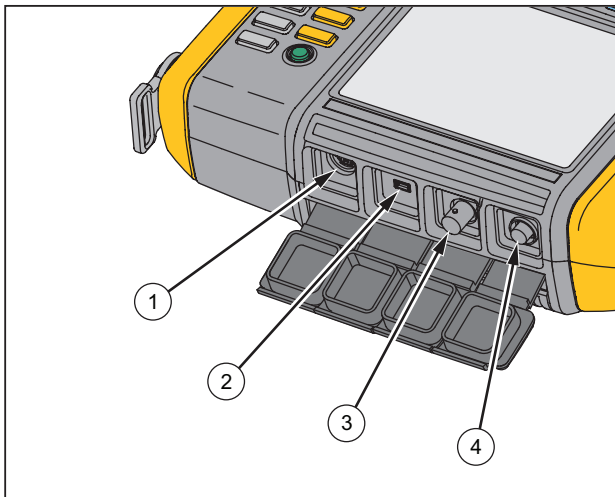

gbk01.eps

Figure 3-2. Accessory Connectors

Table 3-3. Accessory Connectors

Item	Connector	Description
①	Tachometer	Connects the Tachometer
②	USB	Connects the Tester to the PC using a USB cable
③	Sensor	Optional connector for single axis Sensor
④	Sensor	Connects the triaxial Sensor

Start the Tester

Note

Before using the Tester for the first time, charge the battery for at least three hours. For charging procedure, see Battery.

Before using the Tester, make sure that there is sufficient battery charge and free memory.

Push  to turn on the Tester. At power up, the Tester displays the remaining memory and the battery status.

The battery status icon  and the set date and time appear at the top of the display.

Push  and hold two seconds to turn off the Tester.

Note

The first time you turn the Tester on, it displays the Settings screen. It is important to enter the correct information into the setup fields before you start a test, especially the power line frequency. For more information, see Instrument Setup section.

Sensor Setup

The Tester includes a triaxial Sensor with TEDS technology (Transducer Electronic Data Sheets). With this technology, your Tester can identify and automatically read the Sensor configuration. This technology provides:

- Improved results from detailed calibration information
- Reduced configuration time without manual data entry
- Sensor calibration tracking with the last calibration date stored electronically

Compatible Sensors

It is highly recommended to use a Fluke Triaxial Sensor with the Tester. Using a Sensor other than a Fluke Triaxial Sensor will result in misleading diagnoses. The Tester is compatible with single axis Sensors.

Caution

Non-Fluke triaxial Sensors are not compatible with the Tester.

How to Connect the Fluke Sensor

To connect and set up a triaxial Sensor:

1. Attach the cable to the Sensor and tighten the threaded cable sleeve. See Figure 3-3.
2. Connect the cable to the Tester and tighten the threaded cable sleeve.

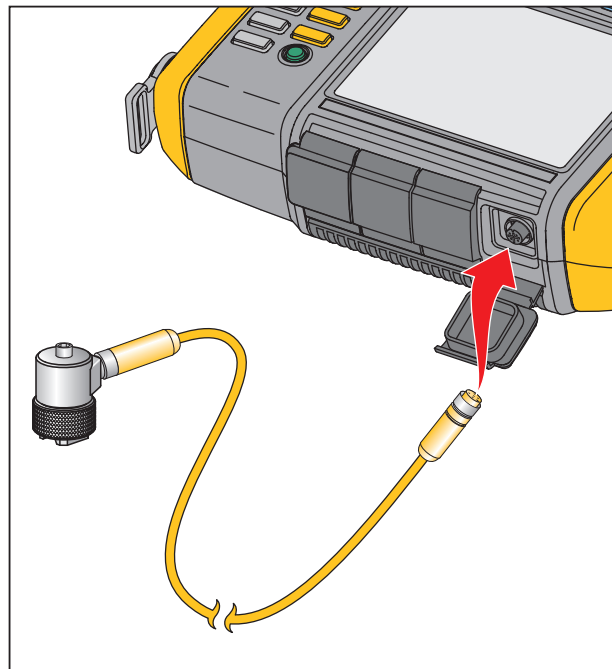

gbk07.eps

Figure 3-3. Sensor Setup and Connection

Sensor Care and Handling

⚠ Caution

- To prevent damage to the piezoelectric element inside the Sensor, do not drop. A faulty Sensor significantly affects the diagnostic quality.
- Do not pull or force the cable while attaching or removing the Sensor.
- Allow the Sensor 10 seconds to warm-up before data collection.
- Make sure that all cables are free from any rotating parts of the machine.
- Always disconnect the Sensor cable from the Tester when not in use.
- Always place the Sensor in the softcase pouch when not in use.

Tachometer Setup

During the Machine Setup procedure, you have to enter the speed/RPM (revolutions/minute) of the rotating machine under test. If the RPM is unknown, you can use the non-contact type laser Tachometer to measure the RPM.

Note

Fluke recommends the use of a Tachometer for variable-frequency drives (VFD) to determine the running speed under varying load conditions.

How to Measure RPM with the Tachometer

To make a Tachometer measurement:

1. Attach the Tachometer to the 6-pin DIN connector on the Tester. See Figure 3-4.

⚠ Warning

To avoid injury when attaching reflective tape to the machine, stop the rotating machine. Attach a piece of reflective tape onto the shaft or other rotating part of the machine. Restart the machine and wait until it reaches its normal operating conditions.

2. Aim the laser beam towards the attached reflective tape.
3. Hold the Tachometer firmly and steady.

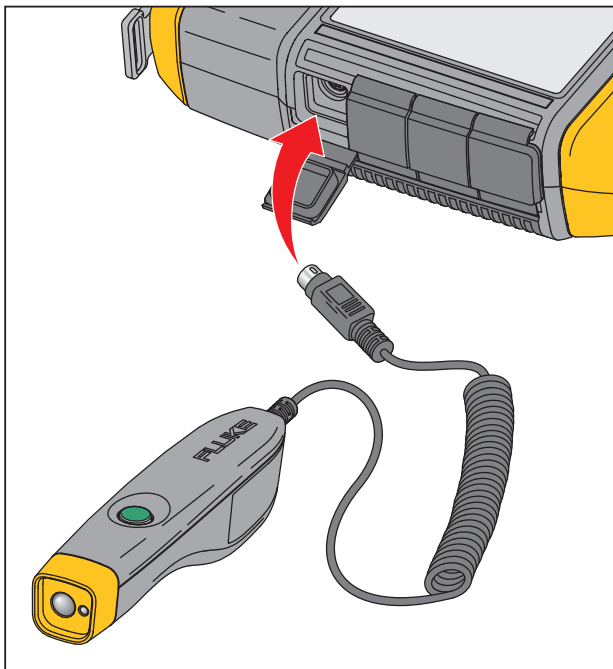

gbk06.eps

Figure 3-4. Tachometer Setup and Connection

4. When the RPM entry screen appears on the display, the power button on the Tachometer lights to indicate that the Tester is ready for RPM measurement.

5. Push and hold the trigger button of the Tachometer to start measuring.
6. After the beep, when the final measured value shows in green on the Tester, release the trigger button.

The Tester automatically turns off the Tachometer.

Laser Safety Precautions

⚠ ⚠ Warning

- **The Tachometer contains a Class 2 laser pointer.**
- **To avoid eye damage, do not point laser directly at eye or indirectly off reflective surfaces.**
- **Use, other than those specified here, may result in hazardous laser radiation exposure.**
- **Do not use Tachometer in a manner not specified in this document or the protection provided by the equipment may be impaired.**
- **Do not aim the laser beam at people or animals.**

⚠ Caution

- **Keep the Tachometer out of the reach of children.**
- **Do not open the Tachometer. The Tachometer has no user serviceable parts.**
- **When not in use, always place the Tachometer in its protective cover.**

How to Access Help

The Tester has context sensitive Help. With the Help feature you can quickly find additional information while you set up the Tester and make measurements. The Help content that shows depends on the current task selection. Push **INFO** at any time to view specific Help for the current task. The Help for the Tester includes these pages:

- **Setup FAQ** (Frequently Asked Questions)
- **Measurement FAQ**
- **Diagnosis FAQ**
- **Glossary**
- **Troubleshooting**

Instrument Setup

Push **INSTRUMENT SETUP** or the **Instrument Setup (F3)** softkey to display the setup options:

- **Self test**
- **Settings**
- **Clear memory**

Use the Dial to highlight an option. Push the Dial or **Enter (F3)** to select that option.

Self Test

The **Self test** option tests the internal modules of the Tester. When you select the **Self test** option, the Tester runs a test module and then displays the self test results as pass or fail.

Push the **Done** softkey to go back to Instrument Setup.

Note

If the self-test fails, contact Fluke Service.

Settings

To edit the Tester settings in Table 3-4, select the **Settings** option. Push **Next Page (F2)** to move down the screen and edit the additional settings.

Note

Before you take a measurement, make sure the power line frequency is set correctly.

Table 3-4. Tester Settings

Option	Description
Power line freq	Set the ac power line frequency to 60Hz or 50Hz . The diagnostic quality of a test depends on the correct selection of the ac power line frequency.
Date format	Set the Date format as d/m/y or m/d/y
Date	Scroll and set the Day , Month , and Year fields
Time format	Set the Time format as 12Hr or 24Hr
Time	Scroll and set the Hour , Minute , and AM or PM fields
Beeper	Set the Beeper as ON or OFF
Backlight brightness	Set the display brightness as High or Low
Power save	Scroll and select to set the delay time for the Sleep Mode. If no key is pushed during the set time, the Tester goes into the sleep mode to save battery power. Any key push cancels the sleep mode and resumes normal operation.

Table 3-4. Tester Settings (cont.)

Option	Description
Backlight duration	Scroll and select to set the delay time for the display backlight. If no key is pushed during the set time, the backlight turns off to save battery power. The backlight turns on when any key is pushed.
Time waveform capture	<p>Scroll and select the number of measurements where the time waveform is to be captured. The Tester captures and stores the time waveform data for the selected number of measurements.</p> <p style="text-align: center;"><i>Note</i></p> <p><i>Capture and review of time waveform data is useful in advanced vibration analysis, but keep in mind that data capture uses a significant amount of memory. Captured time waveforms can only be viewed in the Viewer Software, not in the Tester.</i></p>
Units	Scroll and select a unit of measurement as US or metric. Also select the units for the vibration amplitude. VdB and in/sec for US. VdB* indicates VdB Europe and mm/sec for Metric.
Language	Scroll and select a language.
Overall Vibration Unit	Scroll and select a unit of measurement as US or metric. Units are g, m/s ² , in/s, mm/s, mils, um. Also select calculated displacement.

Clear Memory

Select the **Clear Memory** option on the Instrument Setup screen to erase all measurement and diagnosis data. The Tester prompts you to clear the memory.

If you select **Yes**, another confirmation message displays:

Select **Yes** to clear the memory. This action erases all stored measurement and diagnosis data.

Chapter 4 Operation

Title	Page
Start the Tester	4-3
Create a New Machine Setup	4-3
Machine Setup	4-4
Motor Input (Driver) Information.....	4-5
RPM Entry	4-7
Coupling Information	4-7
Transmission with Closed Coupling.....	4-8
Transmission without Closed Coupling.....	4-9
Driven Component.....	4-10
Pump	4-10
Fan	4-11
Compressor	4-12
Blower.....	4-13
Spindle.....	4-13
Transmission Component.....	4-13
Gearbox	4-13
Belt Drive	4-16
Copy an Existing Machine Setup.....	4-18
Edit the Saved Machine Setup	4-19

Before You Measure.....	4-20
Select Measurement Locations.....	4-20
Total Number of Measurement Locations.....	4-21
Sensor Orientation.....	4-22
Sensor Mounting.....	4-23
How to Measure Vibration.....	4-25
How to Diagnose.....	4-32
Fault Types.....	4-32
Overall Vibration.....	4-33
Severity Scale.....	4-34
Fault Details and Vibration Spectrum.....	4-35
How to Access the Memory.....	4-38
View by Machine Setup.....	4-39
View by Measurement Date.....	4-39
View by Last Diagnosis.....	4-40

Start the Tester

Note

- Before using the Tester for the first time, charge the battery for at least 3 hours. For charging procedure, see Battery.
- Before using the Tester, make sure that there is sufficient battery charge and free memory.

Push **1** to turn on the Tester. At power up, the Tester displays:

Note

The first time you turn the Tester on, it displays the Settings screen. It is important to enter the correct information into the setup fields before you start a test, especially the power line frequency. For more information, see the Instrument Setup section.

Create a New Machine Setup

Before recording data, create a Machine Setup name for the machine under test. To create a new Machine Setup name:

1. Push **New Machine (F1)** on the startup screen. Or push **SETUP**. The tester displays the options:
 - **Set up new machine**
 - **Copy Machine Setup**
2. Select **Set up new machine**. An alphanumeric keyboard appears.

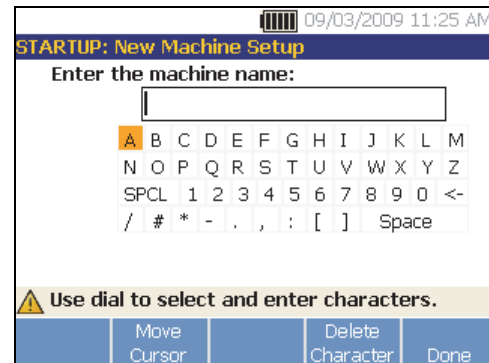

gbk41.bmp

3. Use the Dial to highlight characters.
4. Push the Dial to select a character. A maximum of 15 characters is allowable.
5. Push **Move Cursor (F2)** to move the cursor in the text box one space to the left.
6. Push **Delete Character (F4)** to remove the last character entered in the text box.
7. After you enter the name, push **Done (F5)**. The new Machine Setup name appears in the name field.

Table 4-1 describes the softkey functions for the New Machine Setup screen.

Table 4-1. New Machine Setup Functions

Softkey	Function
Edit Name	Edit the Machine Setup name
Next	Go to the first Machine Setup screen
Exit	Exit to the Startup screen.

Machine Setup

For the best machine analysis and diagnosis, the Tester has to understand the layout and components of the machine. The Machine Setup wizard guides you through several questions about the profile of the machine. These machine setup values must be correct for valid diagnostic results.

Note

All questions in the Machine Setup Wizard are required to generate a diagnosis unless otherwise labeled "optional." Including optional information will improve the results of the final machine diagnosis.

Once you create a Machine Name, the Tester starts the Machine Setup wizard and you enter the parameters of the machine under test. The Machine Setup wizard displays the options sequentially based on the input you give and organizes the options into these categories:

- Motor Input (Driver)
- Coupling and Transmission
- Driven Components

Note

Push **INFO** to access the on-board help for any Machine Setup option.

As you select the options, the Tester displays a corresponding drivetrain image template at the top of the display.



gbk115.bmp

The Machine Setup Wizard uses combo boxes. A combo box is a combination of a drop-down list or list box. You can choose from the list of existing options. To make a selection:

1. Push **Enter** to activate the combo box.
2. Rotate the Dial to highlight different options in the combo box.
3. Push **Enter** to confirm the selection. Depending on the component you select, the options appear for the details of the component.

Motor Input (Driver) Information

Entering an accurate running speed (RPM) is critical to receiving a proper diagnosis. An accurate running speed helps the diagnostic engine in the Tester discern different fault conditions. The motor nameplate or manual also lists the running speed.

If an ac motor uses a variable frequency drive (VFD), it operates under a varying load that influences the vibration signal. It is important to obtain the correct RPM using a tachometer. Or, refer to the frequency on the motor controller label. For consistent diagnoses over time, it may be necessary to reduce or increase the load on the motor to match the load from previous measurements.

Measuring VFDs requires entering RPM at the time of measurement (instead of relying on RPM values in the Machine Setup) due to variable loads. To obtain an accurate RPM value, use the Tachometer provided with the Tester or obtain the frequency value from the drive controller itself. To convert the frequency value to RPM, calculate:

$$\text{Hz} * 60 = \text{RPM}$$

Horsepower (HP) or kilowatt (kW) input is required for the diagnostic system to identify the number of measurement locations.

Table 4-2 is a list of the options for the motor input.

Table 4-2. Motor Input Options

Selection	Option	Description
Select motor type	AC	Select the motor type of the machine under test.
	DC	
AC motor with VFD	Yes	For ac motor type, identify the motor as VFD (variable-frequency drive) or not.
	No	
Enter Speed in RPM	RPM Entry screen	RPM Entry screen appears. Use the Tachometer to get the RPM. Or, if you know the RPM, enter the value manually. See <i>RPM Entry</i> .
Enter nominal HP (US) or Enter nominal kW (metric)	Numeric keyboard entry	Push Keyboard to access the numeric keyboard. Enter the HP (Horsepower) or the kW of the motor.
Motor mounted	Horiz (Horizontal)	Identify the motor mounting as horizontal or vertical. It is important to enter the motor mounting as it affects Sensor orientation.
	Vert (Vertical)	
Motor bearing type	Roller	Select the bearing type in the motor. Different bearing types have distinct vibration signatures.
	Journal	
Motor is detached from drivetrain	Yes	Are you testing the motor only. If the motor is detached from the drivetrain, select Yes.
	No	

RPM Entry

When an RPM value has to be entered, the RPM entry screen opens.

Use the Tachometer to measure the RPM. See *Tachometer Setup* to set up the Tachometer and measure the RPM. After you set the RPM value, the Tester goes back to the Machine Setup wizard.

To manually enter the RPM value:

1. Push **Manual Entry (F2)**. The Tester displays a numeric keyboard.

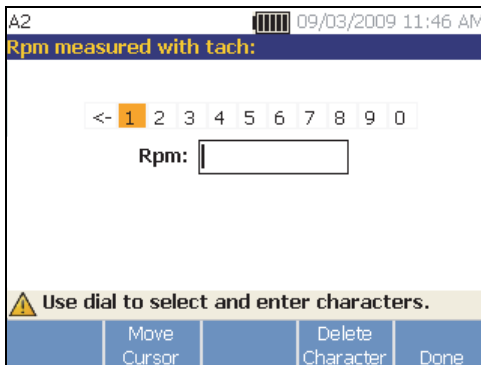

gbk43.bmp

2. To select a character, use the Dial to highlight the value. Or, use **Move Cursor (F2)** to highlight the value.
3. Push the Dial to select the value.
4. To delete a character, use **Delete Character (F4)**.
5. Push **Done (F5)** to go back to the Machine Setup wizard.

Coupling Information

If the machine consists of a driven component coupled with a motor, select **No** to the previous option. Options for the closed coupled machine appear based on the selection you make.

Transmission with Closed Coupling

Table 4-3 is a list of the options for a transmission with a closed coupling.

Table 4-3. Closed Coupling Transmission Options

Selection	Option	Action	Option	Action	Description
Motor directly bolted to:	Centrifugal pump	Scroll and select the driven component that connects to the motor (driver)	Number of vanes (optional)	Numeric keyboard entry	This is optional information. Push Keyboard to access the numeric keyboard. Enter the appropriate number for the option.
	Gear pump		Number of gear or screw teeth (optional)		
	Fan		Number of blades (optional)		
	Cntfgl Comp (Centrifugal compressor)		Number of compressor vanes (optional)		
	Screw/lobe pump		Number of teeth/lobes (optional)		
<p><i>Note: Vanes, gear teeth, screw teeth, pistons and fan blades generate distinct vibration signatures. Enter the correct number for proper diagnosis.</i></p>					

Transmission without Closed Coupling

Table 4-4 is a list of the options for a transmission without a closed coupling.

Table 4-4. Transmission without Closed Coupling Options

Selection	Option	Description
Coupling between motor and next component	Yes	Is there a coupling between motor (driver) and the next component in the drivetrain? Select Yes or No accordingly.
	No	
Next component	Pump	Scroll and select the next component in the drivetrain from the list.
	Fan	
	Compressor	
	Blower	
	Spindle	
	Gearbox ^[1]	
	Belt drive ^{[1] [2]}	
	Chain drive ^{[1] [2]}	
<p>[1] If you select Gearbox, Belt drive, or Chain drive, the options for the details of the transmission drive appear. See <i>Transmission Component</i> for related options.</p> <p>[2] These selections are unavailable if there is a flexible coupling between the motor and the next component.</p>		

Driven Component

Depending on the component selection, the options for the details of the driven component appear.

Pump

Table 4-5 is a list of the pump options.

Table 4-5. Pump Options for Driven Components

Selection	Option	Action	Option	Action	Description
Bearing type	Roller	---	---	---	Select the bearing type in the pump.
	Journal	---	---	---	
Pump type	Centrifugal	Scroll and select the pump type	Impeller is supported by	Two bearings	Scroll and identify the impeller support.
				Overhung	
	Propeller		Number of vanes (optional)	Input value between 2 and 20 with keyboard.	This is optional information. Push Keyboard to access the numeric keyboard. Enter the number for the option.
			Number of vanes (optional)	Input value between 2 and 20 with keyboard.	
			Number of vanes (optional)	Input value between 2 and 20 with keyboard.	
	Screw/lobe		Number of teeth/lobes (optional)	Select 2 through 12	This is optional information. Scroll and select the number.
Piston	Number of pistons (optional)	Select 2 through 13			

Fan

Table 4-6 is a list of the fan options.

Table 4-6. Fan Options for Driven Components

Option	Selection	Description
Driven component bearing type	Roller	Select the bearing type in the fan.
	Journal	
Fan is supported by	Two bearings	Scroll to identify the fan support.
	Overhung	
Number of fan blades (optional)	Numeric keyboard entry	This is optional information. Push Keyboard to access the numeric keyboard. Enter the number of fan blades.

Compressor

Table 4-7 is a list of the compressor options. Different setup options are available based on the compressor selection.

Table 4-7. Compressor Options for Driven Components

Selection	Option	Action	Option	Action	Description
Driven component bearing type	Roller	---	---	---	Select the bearing type in the compressor.
	Journal	---	---	---	
Compressor type	Centrifugal	Scroll and select the compressor type	Number of vanes (optional)	Select 9 through 50	Scroll and select the number of vanes in the compressor.
	Screw		Number of screw teeth or threads (optional)	Select 2 through 8	Scroll and select the number of screw teeth or threads of the compressor.
	Piston		Number of pistons (optional)	Select 2 through 12	Scroll and select the number of pistons.

Blower

Table 4-8 is a list of the blower options.

Table 4-8. Blower Options for Driven Components

Option	Selection	Description
Driven component bearing type	Roller	Select the bearing type in the blower.
	Journal	
Number of blower lobes	Select 2 through 12 (optional)	Scroll and select the number of blower lobes.

Spindle

Only single or simple shafts can be analyzed with the Tester.

Transmission Component

If you select the component as **Gearbox**, **Belt drive**, or **Chain drive**, the Setup Wizard shows the options for the transmission component.

Gearbox

To diagnose gearbox faults properly, it is important to characterize the gear ratios used. The Tester accepts any of three possible methods: shaft speeds, gear tooth counts, or gear ratios.

If selecting the shaft speed method for single speed changers, it is critical to use the same method (manual or tachometer) on both input and output shafts.

Table 4-9 is a list of the gearbox options. Depending on the known components, more options appear for the details.

Table 4-9. Gearbox Options for the Transmission

Selection	Option	Action	Option	Description
Gearbox bearing type	Roller	Select the gearbox bearing type		---
	Journal			
Number of speed changes	1	Scroll and select the number of speed changes.		
	2			
	3			
What is known?	Shaft speeds	Depending on the known information, scroll and select that option.		
	Gear ratios		Push Keyboard to access the numeric keyboard. Enter the gear ratios in their respective fields.	
	Gear tooth count		Push Keyboard to access the numeric keyboard. Enter the number of gear teeth in their respective fields.	

Next, the options for the Driven components show on the Tester screen. See Table 4-10.

Table 4-10. Driven Component Options

Option	Selection	Description
Is there a flexible coupling between gearbox and next component:	Yes	Configure the setup with or without a coupling between the gearbox and the coupling.
	No	
Next component that gearbox is attached to:	Pump	Scroll and select the next component in the drivetrain from the list. See <i>Driven Component</i> for the options.
	Fan	
	Compressor	
	Blower	
	Spindle	
	Belt drive^[1]	
	Chain drive^[1]	
[1] These selections are unavailable if there is a flexible coupling between the gearbox and the next component.		

Belt Drive

Obtaining the RPM value using the laser tachometer is the preferred method for determining running speed. However, the output RPM value can be calculated using simple arithmetic.

For simple reduction two-pulley (sheave) systems, use the formula that follows to solve for the RPM of the driven pulley:

$$\frac{\text{Diameter, driver pulley (sheave)}}{\text{Diameter, driven pulley (sheave)}} = \frac{\text{RPM, driven pulley (sheave)}}{\text{RPM, driver pulley (sheave)}}$$

Table 4-11 is a list of the options for the belt drive components.

Table 4-11. Drive Options for the Transmission

Selection	Option	Description	Action	Next Component	Action
Belt Drive	Input shaft speed	RPM entry screen appears	Use the Tachometer to set the RPM. Or, you can enter the speed with the numeric keyboard.	Pump	Scroll and select the next component in the drivetrain from the list. See <i>Driven Component</i> for available options.
	Output shaft speed			Fan	
	Rotation speed (optional)			Compressor	
Chain Drive	Input shaft speed			Blower	
	Output shaft speed			Spindle	
	Tooth count (optional)				

After you enter all the machine information, the Change Machine Name screen appears. Table 4-12 is a list of the softkey functions for the Change Machine Name screen.

Table 4-12. Change Machine Name

Softkey	Function
Previous Page	Go back to the previous screen.
Review Summary	Go to the first Machine Setup screen to review the selections and inputs made with the Machine Setup Wizard.
Done	Save the Machine Setup.
Edit Name	Displays the alphanumeric keyboard to edit the machine name.
Exit	Exit to the Startup screen.

When you save the Machine Setup, the Tester shows the Saved Machine Setup screen to indicate the setup was saved. Table 4-13 is a list of the softkey functions for the Saved Machine Setup screen.

Table 4-13. Saved Machine Setup Functions

Softkey	Function
New Setup	Displays Set up new machine , Copy Machine Setup , and Change a Machine Setup options.
Measure	Go to the Measurement screen to take a measurement from a certain location.
Exit	Exit to the Startup screen.

Copy an Existing Machine Setup

When you have multiple machines to test that are identical to one another, you can create one Machine Setup and make multiple copies with a unique Machine Setup name.

1. Push **SETUP** to view the New Machine Setup screen options:
 - **Set up new machine**
 - **Copy Machine Setup**
 - **Change a machine setup**

Or, push **New Machine (F1)** in the Startup screen to view the New Machine Setup screen options.

2. Select **Copy Machine Setup**. The next screen is a list of the existing Machine Setups.
3. Use the Dial to scroll through the existing Machine Setups.
4. Push **Copy (F3)**. The alphanumeric keyboard appears.

5. Enter the new machine name and push **Done (F5)**. The new name appears on the screen.
6. Push **Next (F4)** to copy the Machine Setup.

The Tester shows the Copy Machine Setup screen. Table 4-14 is a list of the softkey functions for the Copy Machine Setup screen.

Table 4-14. Copy Machine Setup Functions

Softkey	Function
Review Setup	Review the existing Machine Setup screen-by-screen and edit the settings.
Measure	Go to the Measurement screen to take a measurement.
Exit	Exit to the Startup screen.

Edit the Saved Machine Setup

To change a Machine Setup:

1. Push **SETUP** to view the New Machine Setup screen options:
 - **Set up new machine**
 - **Copy Machine Setup**
 - **Change a machine setup**
2. Select the **Change a Machine Setup** option. The screen shows a list of the saved Machine Setups.
3. Or, push **Saved Machines** in the startup screen to view the saved Machine Setups.
4. Use the Dial to select a Machine Setup.
5. When the Machine Setup is highlighted, push **Edit Setup (F3)**. The Machine Setup screen appears and you can edit the settings.
6. Editing the settings is similar to creating the Machine Setup for the first time. Refer to the *Machine Setup* section for more information about the Machine Setup settings.

Once you edit the machine settings, the Change Machine Name screen appears.

Table 4-15 is a list of the softkey functions for the Change Machine Name screen.

Table 4-15. Change Machine Name Functions

Softkey	Function
Previous Page	Go to the previous screen.
Review Summary	Go to the Machine Setup screen to review the selections and inputs made in Machine Setup wizard.
Done	Save the Machine Setup with new settings.
Edit Name	Displays alphanumeric keyboard to edit the machine name.
Exit	Exit to the Startup screen.

Note

You can create a Machine Setup and transfer it to and from the Tester with the Viewer Software. For more information, see Chapter 5, Viewer Software.

Before You Measure

Sensor orientation is critical to ensure repeatable data and consistent diagnoses over time. Once you have mounted the Sensor onto the machine to be tested and created a Machine Setup, the Tester is ready to measure.

⚠ Caution

To prevent damage to the Tester, do not take a measurement while connected to ac power source.

Select Measurement Locations

The optimum measurement location is as close to the machine bearings as possible. A solid metal surface between the bearing and Sensor is ideal. The solid metal casting effectively transmits the vibration signals emitted by bearings. Do not put the Sensor on bearing caps, fan housings, sheet metal shrouds, non-metallic materials, and other metal-to-metal joints as they can significantly distort the vibration signals.

Tips for measurement location:

- For consistent diagnoses over time, it is important to measure with the same parameters. You must place the triaxial Sensor at the exact same location on a machine and with the same orientation.
- Do not take bearing measurements from a foundation or fabricated base.

- Do not mistake seal locations for a bearing measurement location on pumps.
- Attach the Sensor to a clean, flat, bare metal surface if possible. Thick layers of paint, grease, oil, or other matter reduce both the holding force of the magnet and the high frequency response of the Sensor.
- Avoid mounting the Sensor on thin surface areas, such as fan shrouds and cooling fins.
- The position of the cable connection on the Sensor should be parallel or perpendicular to the drive shaft whenever possible.
- For close-coupled machines where the motor is directly bolted to the driven component, take all measurements from the motor. If motor is <40 hp (30 kW), take the measurement from the motor's driven end. If the motor is >40 hp (30 kW), take the measurement from both the motor's driven end and free end.

⚠ Warning

To prevent personal injury, do not allow Sensor location and mounting to supersede safety. Always consider the best combination of locations and mounting techniques that personal safety will allow.

Total Number of Measurement Locations

Measurement locations correlate to the bearing locations and their sequence follows the flow of energy beginning from the free end of the motor to the end of the drivetrain.

Take measurements in this same order, beginning with the free end of the motor and working downstream. See Figure 4-1.

Fluke recommends that you make two measurements for each component in the drivetrain (unless the bearings are less than 36 in (1 m) apart). For optimum diagnostic quality, make each measurement at the bearing location when possible.

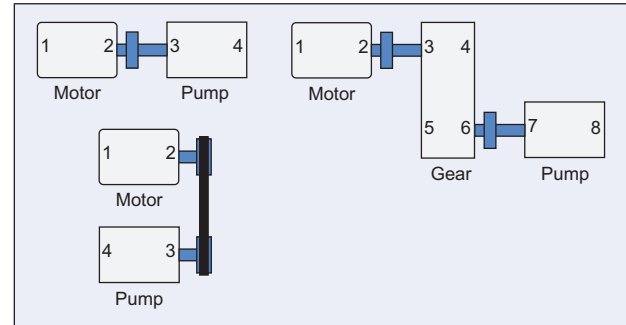

gbk09.eps

Figure 4-1. Sensor Location

Note

*Start numbering from the motor free end.
Number the bearings with the flow of energy.*

Sensor Orientation

Consistent Sensor orientation is critical to ensure repeatable data and consistent diagnoses over time. The Tester uses a triaxial Sensor that combines three transducers into a single housing. These three transducers simultaneously measure the vibration data from three axes or directions:

- Axial (A)
- Radial (R)
- Tangential (T)

The axes are oriented to the drivetrain shaft and vary depending on the horizontal or vertical orientation of the drivetrain. See Figure 4-2.

Note

If you define the Sensor orientation incorrectly in the user interface, the diagnostic engine is unable to associate the vibration signals with the correct axes. The result is a false diagnosis from the Tester.

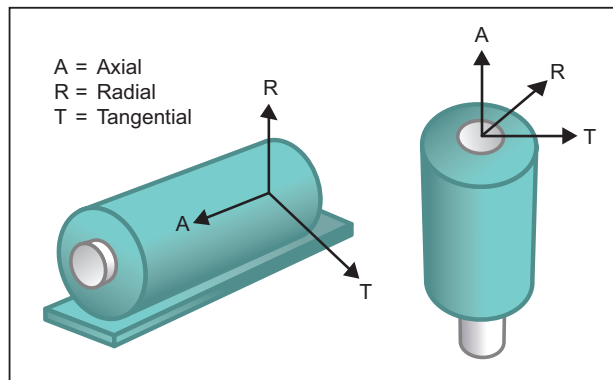

Figure 4-2. Axes Orientation

The Tester uses the machine driveshaft as the common reference point. You must set the orientation of the Sensor cable as either parallel or perpendicular to the driveshaft.

Sensor Mounting

The Tester's diagnoses are largely dependent upon the quality of vibration signal it receives from the machinery under test. The method used to mount a Sensor to the machine directly affects the quality, accuracy, and range of the signal, see Figure 4-3.

In general, permanent mounts, such as stud or adhesive mount, yield the best results. These are best for machines that:

- run at high speeds and frequencies
- have a driving unit that runs at greater than 6000 RPM (for example, vacuum pumps)
- include a speed changer (gearbox) that results in an output shaft speed of greater than 5x the input shaft speed
- include an integrated speed changer (for example, centrifugal compressors)

Permanent mountings promote more consistent data if tracking machine condition over time. The advantages and disadvantages of permanent mounts are as follows.

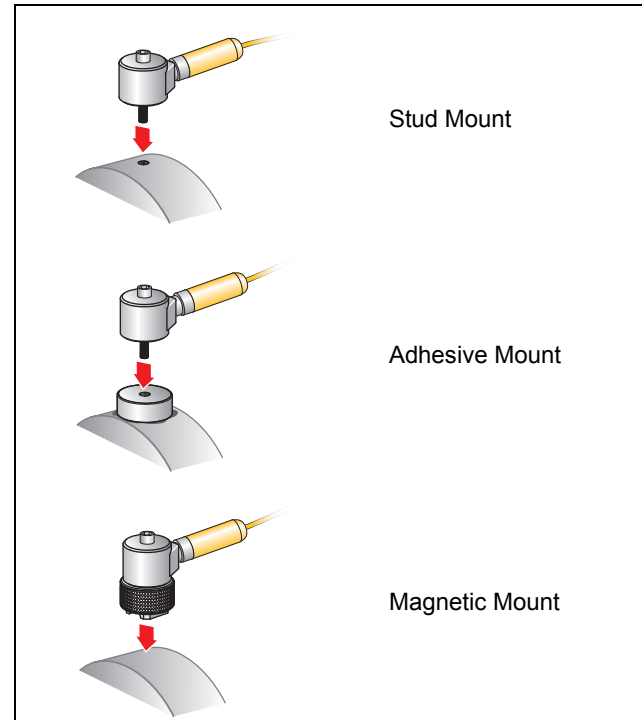

gbk11.eps

Figure 4-3. Sensor Mounting Options

Stud Mounting

Stud mounting is typical for permanently mounted applications. A hole is tapped into a flat section of the machinery housing and the Sensor's stud is screwed into the tapped hole.

Advantages: Highest frequency response, very repeatable data over time. Best diagnostic quality.

Disadvantages: Less practical for “walkaround” troubleshooting due to time needed to screw/unscrew the Sensor from machinery, often difficult to tap a hole in the desired measurement location.

Adhesive Mounted Pads

Typically used for permanently mounted applications. A thin layer of adhesive is applied to the bottom of the mounting pad and placed on a flat section of the machinery housing. The Sensor's stud is screwed into the hole in the mounting pad.

Advantages: High frequency response approaching that of a stud mount without having to tap a hole, very repeatable data over time. Next to a stud mount, best diagnostic quality.

Disadvantages: Less practical for “walkaround” troubleshooting due to time needed to screw/unscrew the Sensor from mounting pad.

The advantages and disadvantages of a temporary mount are as follows.

Magnetic Mounting

The magnetic mount uses either a 2-pole magnet (for rounded surfaces) or flat magnet attached to the Sensor. If you make the measurements at the *exact* same location, each time, repeatable data can be collected over time. Magnet mounts are generally more convenient and allow faster measurement, but some accuracy is lost.

Advantages: Fastest, most convenient method for “walkaround” troubleshooting.

Disadvantages: Diagnostic quality is less than that of stud or adhesive mounts.

Caution

When using a magnetically mounted Sensor, be careful when attaching it to the test surface. The magnet is very strong and could pull the Sensor assembly from your hand and impact the test surface. An excessive impact can damage the Sensor. Hold the Sensor firmly and carefully roll the Sensor onto the test surface to minimize the potential for impact.

How to Measure Vibration

Best practice is to take vibration measurements when the machine is running in a steady state and at normal operating temperature. Fluke recommends that you make two measurements for each component in the drivetrain (unless the bearings are less than 36 in (1 m) apart). For optimum diagnostic quality, make each measurement at the bearing location when possible.

Multiple measurements will improve the diagnostic quality. You need to test all the components, but not necessarily all the possible Sensor locations on each component. Vibration transmits easily through a machine and it will be picked up from each location.

To measure machine vibration with the Tester:

1. Push **MEASURE**. The Measure screen shows the saved Machine Setups ready for measurement.
2. Rotate the Dial to highlight a Machine Setup and push the Dial or **Enter (F3)** to select the saved setup.

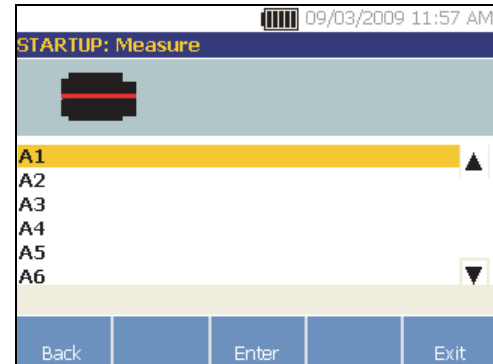

gbk51.bmp

The Tester automatically detects and configures the settings for the Sensor unless the drivetrain includes a variable frequency drive (VFD) or dc motor. If there is a VFD or dc motor, you must verify the RPM in the RPM Entry screen which appears next.

3. To enter the RPM, choose a method:
 - Retake the RPM measurement.
 - Manually enter the RPM.
 - Push **Skip** to skip the RPM Entry screen.

The Tester configures the settings and detects the Sensor.

Note

Because the current running speed is so critical for correct diagnosis, it is a best practice to use a Tachometer on VFD motor controllers. Or, refer to the frequency on the motor controller label before you take a measurement.

If a single axis Sensor is detected, the Tester asks for the sensitivity of the Sensor.

4. To input the sensitivity value of the Sensor, push **Keyboard (F4)** and enter the value.
5. Push **Continue**.

Once the Sensor is selected, a new screen shows the options:

- **New orientations / locations**
- **Use last orientations / locations**

Note

*The first time you take a measurement, draw or paint a line on the machine to indicate the Sensor measurement location. Use an arrow to indicate the Sensor orientation. If you take measurements at **exact same locations** and with **exact same Sensor orientations**, you can push **Use last orientations/locations**. This will bypass the location and orientation screens and take you directly to the data collection screen.*

6. Select **New orientations / locations**. The Sensor Placement screen appears.

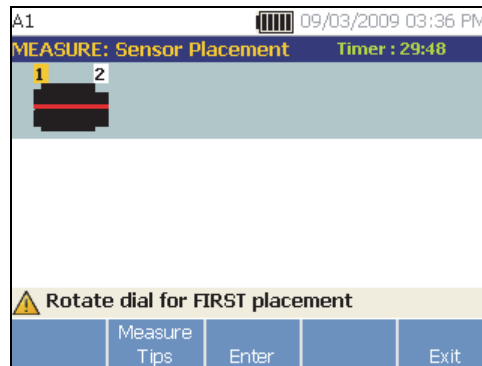

gbk56.bmp

7. Rotate the Dial to select the location for the first Sensor placement. Locations are shown above the drivetrain image. The time available for taking measurements is shown in the top right side of the display.

Note

The vibration from a drivetrain may change depending on the load and ambient temperature of the motor. You must finish a measurement within 30 minutes. If not, the “Measurement Timeout” message appears and redirects you to select the Sensor orientation and location.

8. Push **Enter (F3)** to select the location. The Tester shows that the Sensor is located.

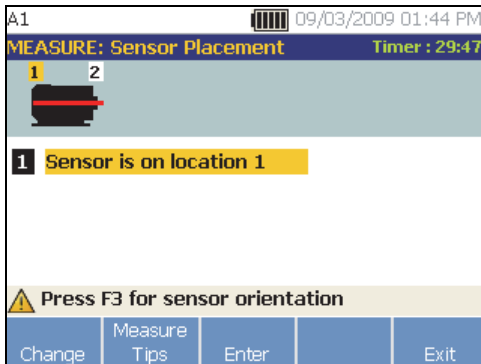

gbk57.bmp

Table 4-16 is a list of the softkey functions for the Sensor Placement screen.

Table 4-16. Sensor Placement Functions

Softkey	Function
Change	Go back to the previous screen to change the Sensor location.
Measure Tips	Display information and tips for taking measurements.
Enter	Displays the Sensor Orientation screen.
Exit	Exit to the Startup screen.

9. Push **Enter (F3)** to select the Sensor orientation.

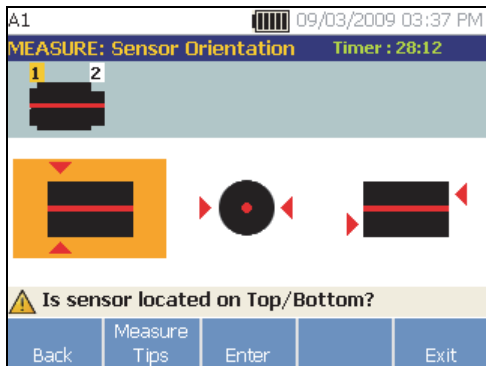

gbk58.bmp

10. Use the Dial to select the correct position of the Sensor the location:

- For horizontal mountings select: **Top/Bottom, Side, or End**
- For vertical mountings select: **Front/Back, Side, or End**. The first time you make a measurement, identify the side of the motor that is the front. Make a mark on the motor to show the front and the back of the motor for future measurements.

Depending on the Sensor orientation selection, another screen appears.

The Tester uses the driveshaft (depicted as a thick red line in the display) as the primary frame of reference. Orient the Sensor to the driveshaft using the Sensor cable where it exits from the Sensor, telling the Tester whether the cable is parallel or perpendicular to the shaft.

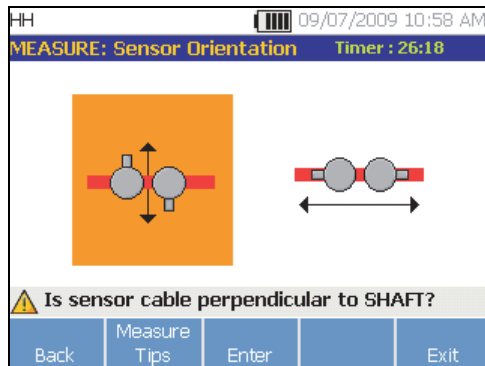

gbk59.bmp

11. Use the Dial and select the alignment of the Sensor cable as it relates to the machine driveshaft. The red line (or dot) on the screen graphic represents the driveshaft. After you select the orientation, the measurement screen appears.

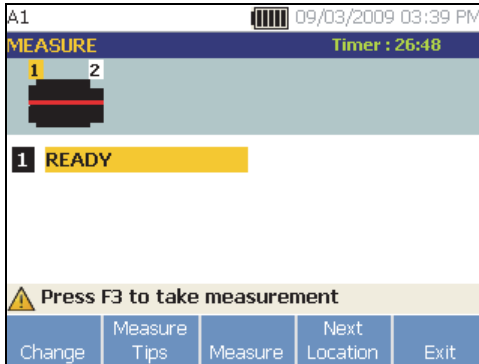

gbk60.bmp

Note

The vibration from a drivetrain may change depending on the load and ambient temperature of the motor. You must finish a measurement within 30 minutes. If not, the “Measurement Timeout” message appears and redirects you to select the Sensor orientation and location.

Table 4-17 is a list of softkey functions for the Measurement Functions screen.

Table 4-17. Measurement Functions

Softkey	Function
Change	Displays the options: <ul style="list-style-type: none"> • Re-orient Sensor: Sensor Orientation screen appears. Change the orientation. • Relocate Sensor: Sensor Placement screen appears. Change the Sensor position.
Measure Tips	Displays information and tips for taking measurements.
Measure	Take measurement from the selected location.
Next Location	Move to the screen where you can select the next location to place the Sensor on the drivetrain.
Exit	Exit to the Startup screen.

12. Push **Measure (F3)** to measure from the selected location. The Tester checks for the Sensor cable connection. If the connection is good, the Tester measures the machine under test. The Measurement Complete screen appears when the measurement is complete.

Table 4-18 is a list of the softkey functions for the Measurement Complete screen.

Table 4-18. Measurement Complete Functions

Softkey	Function
More...	Displays the options to Re-orient and Relocate the Sensor and Re-measure. Push the required softkey to perform the specific task.
Measure Tips	Displays information and tips for how to take measurements.
Diagnose	Diagnose the measurements from a machine.
Next Location	Move to the next Sensor location on the drivetrain.
Exit	Exit to the Startup screen.

13. When taking measurements at multiple locations, push **Next Location (F4)**. The Sensor Placement screen appears for a second placement.

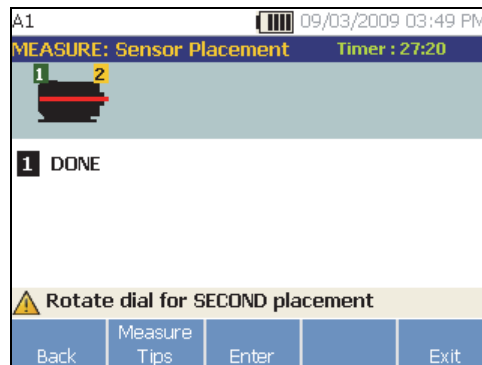

gbk62.bmp

14. Rotate the Dial and select the location for the next placement.
15. Push **Enter (F3)** or use the Dial to select Sensor orientation. The Sensor Orientation screen appears.

16. Select the placement of the Sensor.
17. In the next screen, select the orientation of the Sensor.

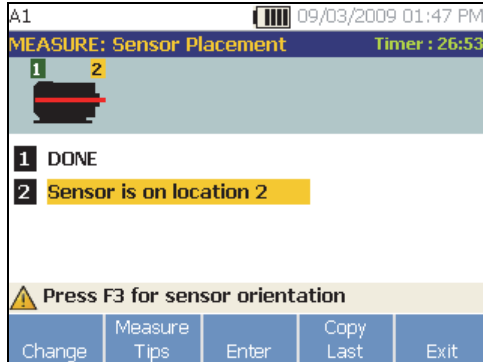

gbk63.bmp

Table 4-19 is a list of the softkey functions for the Sensor placement.

Table 4-19. Sensor Placement Functions

Softkey	Function
Change	Go back to the previous screen to change the Sensor location.
Measure Tips	Displays information and tips for taking measurements.
Enter	Displays the Sensor Orientation screen.
Copy Last	Copy the position and orientation of the last Sensor placement if it is the same.
Exit	Exit to the Startup screen.

18. Push **MEASURE** to take the measurement.

How to Diagnose

Once the Machine Setup is complete and measurement information is collected, the diagnostic engine analyzes the data with a set of powerful algorithms. It also identifies abnormal conditions and pending mechanical failures for the machine.

Fault Types

The Tester can identify four of the most common mechanical problems:

- Bearing Failures
- Misalignment
- Unbalance
- Looseness

The diagnostic engine can identify other mechanical faults (nonstandard faults) in addition to these four basic faults. However, it cannot provide any details on the type of the fault, only its severity.

To diagnose a machine after you take a measurement:

1. Take a measurement. Once the measurement is done, the Tester displays the Measurement Complete screen and prompts you to diagnose the measurements.

See Table 4-18 for a list of the softkey functions for the Measurement Complete screen.

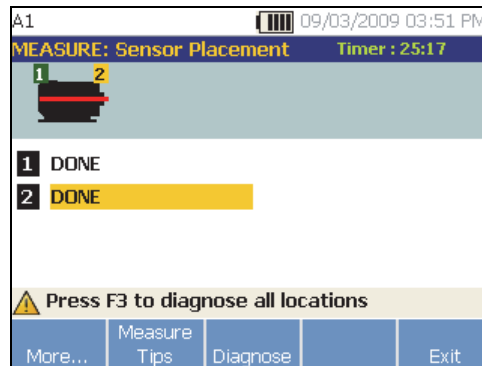

gbk64.bmp

2. Push **Diagnose (F3)**. Or, push the Dial to start the Diagnosis. The Tester analyses the measurement data and displays the diagnostic results.

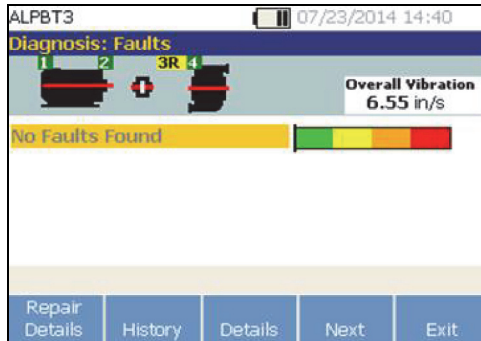

gbk265.bmp

Table 4-20 is a list of the softkey functions for the Diagnosis: Faults screen.

Table 4-20. Diagnosis Faults

Softkey	Function
Repair Details	Displays the prioritized repair recommendations related to a particular diagnosis.
History	Displays the previous diagnosis with same machine.
Details	Displays fault details and cited peaks for selected fault.
Next	Go to the next fault.
Exit	Exit to the Startup screen.

Overall Vibration

The Overall Vibration measurement shows in the upper right of the Diagnosis screen.

Severity Scale

The scale is an indication of severity for any particular fault machine condition.

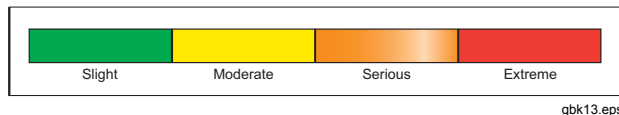

Note

The severity scale should not be associated with time to failure.

The severity scale is based on the intensity of the machine fault at the time of measurement. It is not an indicator of time to machine failure. As conditions change, the severity may change, even appear to improve (for example, immediately after lubrication). However, over time, conditions will worsen with normal machine wear and tear.

Note

Time to failure will vary depending on the equipment type, age, machine load, environmental conditions, and other variables.

Follow these recommended actions for each severity level to avoid failure. In general, the scale may be interpreted as:

- **Slight** No repair action is recommended. Monitor the machine and retest after regular machine planned maintenance to verify maintenance was performed correctly.
- **Moderate** (Months, even up to a year) – Repair action may be needed in the future. A machine failure is possible, so plan accordingly. Increase the frequency of vibration testing on this equipment and review spare parts availability.
- **Serious** (Weeks) – Repair action may be needed before the next planned downtime. There may be other physical evidence of the fault in terms of noise or higher bearing temperatures. Retest the machine within a short period to confirm finds. Limit the run time of the machine, if possible, and determine a fault progression trend to prevent additional component failure.

- **Extreme** (Days) – Consider shutting down the equipment and taking repair action **now** to avoid catastrophic failure. There is likely other physical evidence of the fault in terms of noise, higher bearing temperatures or visible movement. Retest the machine within a short period to confirm finds.

To monitor the condition and degradation of the machine over time, upload the diagnostic information to the Viewer Software and track each fault's severity. See the *Viewer Software* section for more details.

If the diagnosis shows extreme faults but you do not sense any visual or thermal indication of the fault, revisit *Machine Setup* and *How to Measure Vibration*. Verify that you have the correct machine information and measurements. Several factors can result in poor data collection and inaccurate diagnoses:

- Improper speed input
- Improper machine setup
- Thermal transients
- Improper measurement locations
- Taking measurements from a machine which is cycling or surging on and off

Fault Details and Vibration Spectrum

The Tester collects data about vibration motion and compiles this information in the time domain. Then, the Tester transforms it into a frequency domain (spectra) graph where the amplitude of the vibration signal is graphed against the frequency or machine RPM.

Mechanical faults are detected at certain running speeds or frequencies in the spectra. The algorithms identify, or “cite” the abnormal vibration amplitude peaks (cited peaks) at vibration spectra and then diagnose the mechanical fault and severity.

For machines where the Tester found no faults, the Details screen shows spectral data but not cited peaks.

To view fault information:

1. In the fault list, use the Dial to highlight the fault.

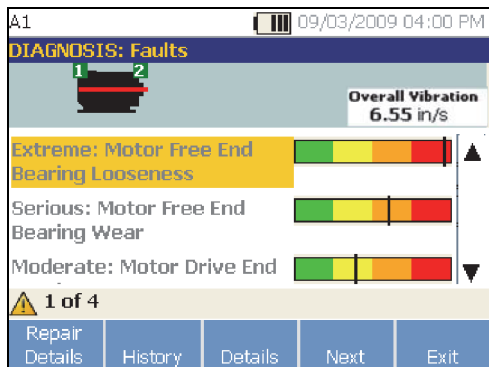

gbk365.bmp

2. Push **Details (F3)**. The Tester displays a table of cited peaks for the selected fault. Each fault is associated with at least one cited peak.

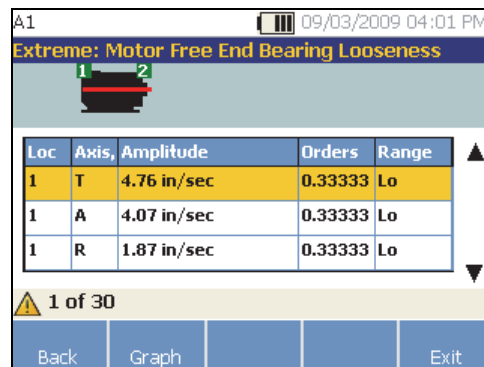

gbk67.bmp

Table 4-21 is a list of the details available for the cited peaks table.

Table 4-21. Cited Peak Details

Label	Description
Loc	Location of fault. Bearing locations are numbered 1 to n, from free end of motor (1) to end of drivetrain (n).
Axis	Direction of vibration signal: Axial, Radial, or Tangential.
Amplitude	Vibration signal amplitude cited from this specific location.
Orders	Multiples of the running speed or frequency and identifies at which running frequency that the cited amplitude peak is detected.
Range	Frequency range of data collection, Hi or Lo.

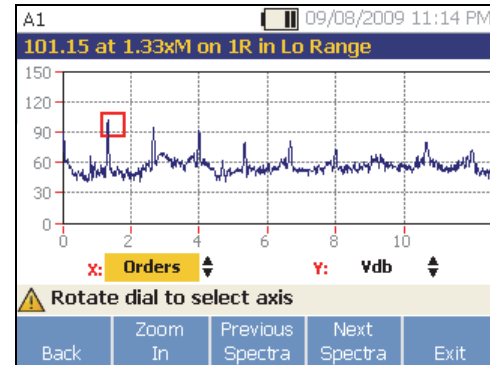

gbk66.bmp

Table 4-22 is a list of the softkey functions for the Diagnosis Spectra screen.

Table 4-22. Diagnosis Spectra Functions

Softkey	Function
Back	Go to the previous screen.
Zoom In	Zoom into the spectra. Push Zoom Out to expand the view of the spectra. To view the spectra in more detail, upload the diagnosis data to a PC to review the spectra with higher resolution. For more information, see Chapter 5 <i>Viewer Software</i> .
Previous Spectra	Displays the spectra of previous cited peak.
Next Spectra	Displays the spectra of next cited peak.
Exit	Exit to the Startup screen.

How to Access the Memory

You can sort the records in memory to make it easier to find a specific record.

1. Push **MEMORY**. The options are:
 - **View by machine setup**
 - **View by measurement date**
 - **View by last diagnosis**
2. Use the Dial to scroll through and select the required option.
3. Push **Enter (F3)** to select the option.

View by Machine Setup

Select **View by machine setup**, to view records sorted by the Machine Setup. Use the Dial to highlight a specific setup and push **View (F4)** to see the records for that setup.

Table 4-23 is a list of the softkey functions for the Existing Machine Setup screen.

Table 4-23. Existing Machine Setup Functions

Softkey	Function
Back	Go to the previous screen.
Delete	Delete a Machine Setup.
Edit Setup	Edit a Machine Setup. For more details about Machine Setup, see the <i>Machine Setup</i> section.
View	View the measurement details (measured date and time) and diagnosis. For more details about diagnosis, see <i>How to Diagnose</i> .
Exit	Exit to the Startup screen.

View by Measurement Date

Select **View by measurement date** to view the records by the recorded date.

1. Use the Dial to select a date and push **View (F4)** to see the machines measured on that date.

Table 4-24 is a list of the softkey functions for the Measurement Date screen.

Table 4-24. Measurement Date Functions

Softkey	Function
Back	Go to the previous screen.
View	View the machine name with date and time of measurement. (For more details about measurement, see <i>How to Measure Vibration</i> .)
Exit	Exit to the Startup screen.

2. Scroll and select the machine with date and time. The tester displays all the records for that date.

Table 4-25 is a list of the softkey functions of View by Measurement Date and Time screen.

Table 4-25. View by Measurement Date Functions

Softkey	Function
Back	Go to the previous screen.
Delete	Delete the measurement details.
Diagnosis	Diagnose the measured data. For more details about diagnosis, see <i>How to Diagnose</i> .
Exit	Exit to the Startup screen.

View by Last Diagnosis

Select **View by last diagnosis** to view the last diagnosis recorded by the Tester.

See Table 4-20 for a list of the softkey functions for the Diagnosis Faults screen.

Chapter 5

Viewer Software

Title	Page
Introduction	5-3
System Requirements	5-3
PC Connections	5-3
Install the Viewer Software	5-5
Uninstall the Viewer Software	5-5
Navigation	5-6
Preferences	5-9
Application Settings	5-10
Upgrades	5-11
Data Transfer	5-11
Import Machine Setup	5-13
Export Machine Setup	5-15
Import Diagnostic Data	5-17
Export Diagnostic Data	5-19
Export Faults Data	5-21
Machine Setup	5-25
Set Up a New Machine	5-25

View Machine Setups	5-26
View Diagnosis	5-29
View Other Data Files	5-33
Time Waveform.....	5-34
Spectra	5-35

Introduction

The Vibration Tester includes Viewer software that lets you do tasks from a computer. With the basic features of the software you can:

- import/export a Machine Setup from the Tester
- set up a new machine
- make a copy of a Machine Setup
- change a Machine Setup
- look at cited peaks graphs, vibration spectra, and time waveforms
- zoom-in and zoom-out of data views
- make a backup of the diagnosis data from a measured machine
- import and look at the thermographic image of a machine

Additionally, you can configure the Machine Setups with the software and export them to the Tester. This Machine Setup procedure is much the same as the Machine Setup wizard in the Tester. For external analysis of the fault data, you can export the fault data, Machine Setup, and diagnosis data, to send to a vibration test consultant.

System Requirements

The minimum PC system requirements to use the Viewer software are:

- Operating system: Microsoft Windows 2000, Windows XP, Windows Vista, Windows 7, or Windows 8.1
- Minimum 1 GB RAM
- One USB port
- CD-ROM disk drive

PC Connections

To connect the computer to the Tester:

1. Power on the computer and the Tester.
2. Connect the USB cable to the USB ports of the computer and the Tester as shown in Figure 5-1. See the marking on the ends of the cable for identifying the Type-A and Mini-B ends.
3. Install the supporting software and Viewer software (if not installed already). See *Install the Viewer Software*.

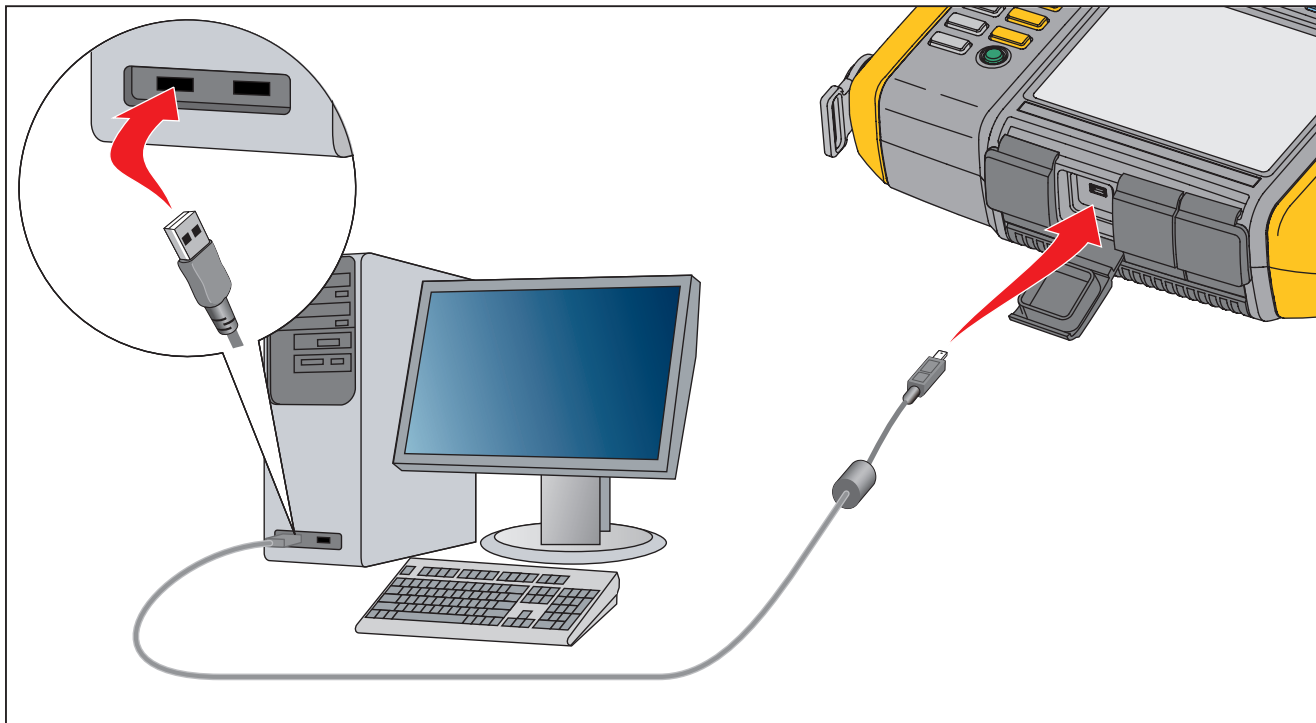

gbk05.eps

Figure 5-1. Tester to PC Connections

Install the Viewer Software

To install the Viewer software:

1. Start the computer.
2. Put the User Documentation / Viewer Software CD-ROM into the CD-ROM drive. The installation automatically starts and the display shows a list of software requirements before you can install the Viewer software.

Note

If the installation does not start automatically, browse through the CD-ROM and double-click Setup.exe to start the installation.

The InstallShield Wizard extracts the Viewer software components and Viewer Software Setup window shows on the display.

3. Click **Install** to start the installation and then follow the instructions on the screen to install the software. You can accept the installation defaults.

After you finish, a Viewer Software entry appears in the Start menu and a shortcut icon shows on the Desktop.

Uninstall the Viewer Software

To uninstall the Viewer software:

1. Go to **Start > All Programs > Fluke 810**.
2. Click **Uninstall Viewer Software**.

To uninstall Microsoft .Net Framework 2.0, Microsoft .Net Framework 3.5 SP1, Microsoft SQL Server 2005 Express, Microsoft SQL Server Compact 3.5 SP1 and ActiveSync 4.5:

1. Choose a method:
 - For Windows XP, go to **Start > Control Panel > Add or Remove Programs**.
 - For Windows Vista and above, go to **Start > Control Panel > Programs > Uninstall a program**.
2. Choose the software to uninstall.
3. Click **Uninstall**.
4. Follow the online instructions to uninstall the software.

Navigation

To start the Viewer software:

1. Start the computer.
2. Click **Start** on the task bar.

3. Click **All Programs**.
4. Click **Fluke 810** and then **Viewer Software**. Or, double-click the **Viewer Software** icon on the Desktop.

The startup screen shows on the display.



gbk85.bmp

Table 5-1 is a list of the menu options and descriptions for the Viewer software.

Table 5-1. Viewer Software Navigation Menus

Menu Option	Description
Transfer	<ul style="list-style-type: none"> • Download the Machine Setup data from the Tester to the computer • Upload the Machine Setup data from the computer to the Tester • Download the diagnosis data from the Tester to the computer • Import or Export diagnostic data • Export the fault data to a PDF or Excel file
Machine Setup	<ul style="list-style-type: none"> • Setup a new machine • View a Machine Setup • Make a copy of a Machine Setup • Change a Machine Setup • Remove a Machine Setup • Export a Machine Setup to a PDF file

Table 5-1. Viewer Software Navigation Menus (cont.)

Menu Option	Description
View Diagnosis	<ul style="list-style-type: none">• View diagnosis• View faults, recommendations, and cited peaks of a measurement• View spectra by location and by cited peak• View diagnostics from another computer• Export diagnostic data to a PDF file• Attach images to individual diagnostic data measurements
Preferences	<ul style="list-style-type: none">• Change application settings• Upgrade the Tester firmware• Delete history• Backup or Restore data• Enable or Disable Tester detection
Help	Shows Viewer software help

Preferences

Click the **Preferences** menu to open the submenus.

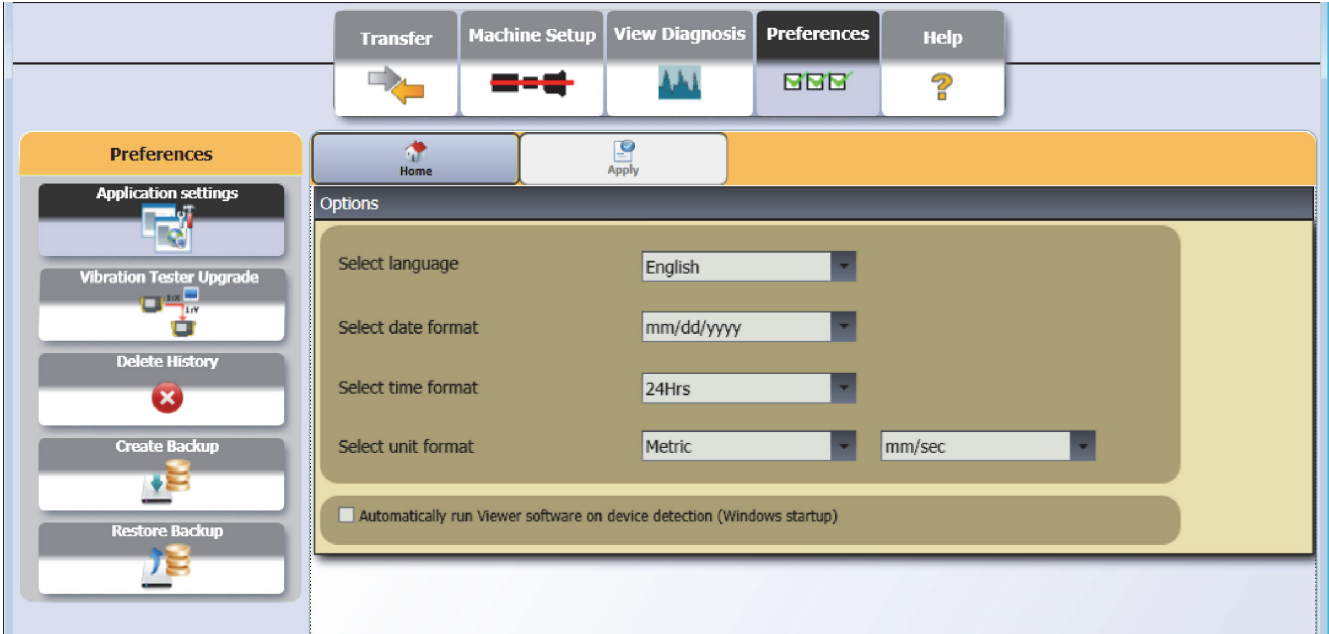

gbk121c.jpg



Application Settings

You can change the display language, date format, and time format with the Application Settings. To open the Application Settings pane: click **Application Settings**.

The Application Settings pane shows on the right side of the window. By default, Application Settings show when you click the **Preferences** menu.

Table 5-2 is a list of the Application Settings.

Table 5-2. Application Settings

Option	Description
Select language	Select a language from the drop-down list.
Select date format	Select the date format as mm/dd/yyyy or dd/mm/yyyy from the drop-down list.
Select time format	Select the time format as 12Hrs or 24Hrs from the drop-down list.
Select unit format	Select the measurement system as US or Metric from the first drop-down list. Next, select the measurement unit from the second drop-down list.
	Click Apply to save changes.
	Click Home to go to the Viewer software Home page.

Upgrades

Periodically, upgrades are available for the Tester. Contact Fluke for upgrade availability. If you have registered your Tester purchase, Fluke automatically sends you an upgrade notice. For complete instructions on how to do an upgrade, see *Maintenance*.

Data Transfer

The Viewer software interface lets you easily move data and files between the Tester and a computer. You can:

- Import the Machine Setup from the Tester to the Viewer software
- Export the Machine Setup from the Viewer software to the Tester
- Import the diagnostic data from the Tester to the Viewer software for enhanced views of the data
- Export diagnostic data
- Export the fault data to a PDF or Excel file

Note

*You must connect the Tester to a computer to see the **Transfer** menu options. The **Device Connectivity** field shows the connection status and the file path. See “PC Connections” for the instructions on how to connect the Tester to a computer.*

To transfer data: click **Transfer**. The Transfer screen and submenus show on the display.

Home
Import to PC

Transfer

Import Machine Setup

Export Machine Setup

Import Diagnostic Data

Export Diagnostic Data

Fault data

Tester connectivity

Connected

Free memory: 791.78 MB

Total memory: 1902.69 MB

Filter

Select date

Start date (mm/dd/yyyy)

End date (mm/dd/yyyy)

? Select ALL
? Transferred
? Not Transferred

	Setup name	Setup date	Record status	Modified date	Transfer status
<input type="checkbox"/>	AC	10/01/2009 12:14:41 PM	Complete	10/01/2009 12:14:41 PM	Not Transferred
<input type="checkbox"/>	A2	10/01/2009 01:38:08 PM	Complete	09/03/2009 05:44:50 PM	Not Transferred
<input type="checkbox"/>	M1	10/29/2009 02:17:32 PM	Complete	10/29/2009 02:17:32 PM	Not Transferred
<input type="checkbox"/>	M3	10/29/2009 03:06:59 PM	Complete	10/29/2009 03:06:59 PM	Not Transferred
<input type="checkbox"/>	A3	09/03/2009 05:42:38 PM	Complete	09/03/2009 05:42:38 PM	Not Transferred
<input type="checkbox"/>	A4	09/03/2009 05:43:34 PM	Complete	09/03/2009 05:43:34 PM	Not Transferred

gbk88.bmp

Import Machine Setup

You can import the Machine Setups from the Tester to the Viewer software with the **Import Machine Setup** submenu.

To import the Machine Setups:

1. Click **Import Machine Setup**. The Import Machine Setup pane shows on the right side of the window. By default, the Import Machine Setup option is selected when you click the Transfer menu.
2. In the Select Date field, fill in the Start Date and the End Date. Or, click  and use the calendar to click on the date.
3. Choose a filter:
 - **Select ALL** to see all the Machine Setups in the Tester.
 - **Transferred** to see the Machine Setups already transferred from the Tester to the Viewer software.
 - **Not Transferred** to see the Machine Setups not transferred from the Tester to the Viewer software yet.

4. Click **Filter**. The Machine Setups show in the window according to the filter selection. The Setup name, Setup date, Record status (Complete or Incomplete), Modified date, and the Transfer status (Transferred to computer or not) for each record also shows in the window.

Note

Click the list header to put the items in ascending or descending order by date.

5. Click the checkbox before the Setup name to select a Machine Setup.

Note

You cannot select a Machine Setup after it is transferred.

6. Click  to import the Machine Setups to the Viewer software. A prompt shows when the import is done.
7. Click **OK**.

The screenshot shows a software interface with a top navigation bar containing 'Home' and 'Import to PC' buttons. Below this is a 'Filter' dialog box with the following fields and options:

- Select date**
- Start date (mm/dd/yyyy)**: 06/17/2009
- End date (mm/dd/yyyy)**: 09/17/2009
- Filter options**:
 - Select ALL
 - Transferred
 - Not Transferred
- Filter** button

Below the filter dialog is a table with the following data:

	Setup name	Setup date	Record status	Modified date	Transfer status
<input type="checkbox"/>	A	09/02/2009 11:44:32	Complete	09/02/2009 11:44:32	Not Transferred
<input type="checkbox"/>	M1	09/02/2009 17:13:32	Complete	09/02/2009 17:13:32	Not Transferred
<input type="checkbox"/>	M2	09/02/2009 17:14:23	Complete	09/02/2009 17:14:23	Not Transferred
<input type="checkbox"/>	M3	09/02/2009 17:15:03	Complete	09/02/2009 17:15:03	Not Transferred
<input type="checkbox"/>	M4	09/02/2009 17:16:17	Complete	09/02/2009 17:16:17	Not Transferred
<input type="checkbox"/>	M5	09/02/2009 17:17:11	Complete	09/02/2009 17:17:11	Not Transferred

gbk89.bmp

Export Machine Setup

You can export the Machine Setups from the Viewer software to the Tester with the **Export Machine Setup** submenu.

To export the Machine Setups from the Viewer software:

1. Click **Export Machine Setup**. The Export Machine Setup pane shows on the right side of the window.

The Tester IDs field shows the connected Tester ID. If the Machine Setup is created in Viewer software, the **PC desktop** entry also shows
2. Select **PC desktop**.

Note

If you choose the Tester ID and the “Not Transferred” filter, the Machine Setups not transferred from that Tester to the Viewer software show in the Setup list.

3. In the Select date field, fill in the **Start Date** and the **End Date**. Or, click  and use the calendar to click on the date.
4. Choose a filter:
 - **Select ALL** to see all the Machine Setups in the Viewer software database.

- **Transferred** to see the Machine Setups already transferred from the Viewer software to the Tester.
- **Not Transferred** to see the Machine Setups not transferred from the Tester to the Viewer software yet.

5. Click **Filter**. The Machine Setups show in the window according to the filter selection. The Setup name, Setup date, Record status (Complete or Incomplete), Modified date, and the Machine Setup status (setup is present or not in the Tester) for each record also shows in the window.

Note

Click the list header to put the items in ascending or descending order by date.

6. Click the checkbox before the name to choose a Machine Setup.
7. Click  to export the Machine Setups to the Tester. A prompt shows when the export is done.
8. Click **OK**.

Home Export to Tester

Filter

Select date

Tester IDs
PC desktop
VibrationTester2
VibrationTester1

Start date (mm/dd/yyyy) 06/17/2009 15

End date (mm/dd/yyyy) 09/17/2009 15

Select ALL
Transferred
Not Transferred

Filter

	Setup name	Setup date	Record status	Modified date	Machine setup status
<input type="checkbox"/>	M101	09/17/2009 17:30:11	Complete	09/17/2009 17:30:11	Setup not present in Tester
<input type="checkbox"/>	M102	09/17/2009 17:30:43	Complete	09/17/2009 17:31:39	Setup not present in Tester
<input type="checkbox"/>	M103	09/17/2009 17:32:05	Complete	09/17/2009 17:32:05	Setup not present in Tester
<input type="checkbox"/>	M104	09/17/2009 17:32:31	Complete	09/17/2009 17:32:31	Setup not present in Tester
<input type="checkbox"/>	M105	09/17/2009 17:32:59	Complete	09/17/2009 17:32:59	Setup not present in Tester

gbk91.bmp

Import Diagnostic Data

You can import the machine diagnosis data from the Tester to the Viewer software for enhanced views of the data. For example, you can magnify the spectra data to see more detail.

To import the diagnosis data:

1. Click **Import Diagnostic Data**. The Import Diagnostic Data pane shows on the right side of the window.
2. In the Select date field, fill in the **Start Date** and the **End Date**. Or, click  and use the calendar to click on the date.
3. Choose a filter:
 - **Select ALL** shows all the diagnosis details of measured Machine Setups in the Viewer software database.
 - **Transferred** shows the diagnosis details of measured Machine Setups that are already transferred from the Tester to the Viewer software.
 - **Not Transferred** to view the diagnosis details of measured Machine Setups that are not transferred from Tester to the Viewer software yet.
4. Click **Filter**. The Machine Setups show in the window according to the filter selection. The Setup name, Measurement ID, Measurement date, and the Transfer status (Transferred to PC or not) for each record also shows in the window.

Note

Click the list header to put the items in ascending or descending order by date.

5. Click the checkbox before the Setup name to choose a Machine Setup.
6. Click  to import the diagnostic data from the Tester to the Viewer software. A prompt shows when the import is done.
7. Click **OK**.

Note

The diagnostic data imported from the Tester is view only. You cannot diagnose a machine with the Viewer software.

The screenshot displays a web application interface. At the top, there are two buttons: "Home" with a house icon and "Import to PC" with a computer icon. Below these is a "Filter" section with a dropdown arrow. The filter panel is titled "Select date" and contains two date input fields: "Start date (mm/dd/yyyy)" with the value "06/17/2009" and "End date (mm/dd/yyyy)" with the value "09/17/2009". To the right of the date fields are three radio button options: "Select ALL", "Transferred", and "Not Transferred", each with a question mark icon. A "Filter" button is located at the bottom right of the filter panel. Below the filter panel is a table with the following data:

	Setup name	Measurement ID	Measurement date	Transfer status
<input type="checkbox"/>	AC	AC-9/1/2009 10:23:28 PM	09/01/2009 22:23:28	Not transferred to PC

gbk93.bmp

Export Diagnostic Data

You can export the diagnostic data in the computer with the **Export Diagnostic Data** submenu. Then you can send the exported file to a consultant for additional analysis. To back up the diagnosis data:

1. Click **Export Diagnostic Data**. The Export Diagnostic Data pane shows on the right side of the window. The pane list includes the Setup Name, Tester Serial No, and Measurement date.

Note

Click the list header to put the items in ascending or descending order by date.

2. In the Select Date field, fill in the **Start Date** and the **End Date**. Or, click  and use the calendar to click on the date.
3. Click the checkbox before the Setup name to choose the data.

4. Click . A window opens for you to browse to the destination folder.
5. Choose the folder. Or, click Make New Folder to make a folder with a new name. The system prompts you to include image files.
6. Click **Yes** to include image files or click **No** to keep the file size smaller. The system prompts when the export is done.
7. Click **OK**.

In the destination folder, data is saved in the **.mdf database file** format. See *View Other Data Files* for instructions about how to open the .mdf database files.

The screenshot shows a software interface with a top navigation bar containing 'Home' and 'New File' buttons. Below this is a 'Filter' section with a 'Select date' dialog. The dialog has two input fields: 'Start date (mm/dd/yyyy)' with the value '06/17/2009' and 'End date (mm/dd/yyyy)' with the value '09/17/2009'. A 'Filter' button is located at the bottom right of the dialog. Below the dialog is a table with three columns: 'Setup name', 'Tester serial number', and 'Measurement date'. The table contains three rows of data.

	Setup name	Tester serial number	Measurement date
<input type="checkbox"/>	AC	VibrationTester1	09/01/2009 22:23:28
<input type="checkbox"/>	TST	VibrationTester1	09/01/2009 19:38:11
<input type="checkbox"/>	TST	VibrationTester1	09/01/2009 19:44:21

gbk95.bmp

Export Faults Data

You can export the severity score for each fault and view the files in **PDF** or **Excel** format. These formats are easy to read, send to a printer, and send by email. In addition, you can track data in Excel to see faults over time.

Note

*Adobe Reader software must be installed on the computer to read a **PDF** file. If not, download the Adobe reader software from <http://www.adobe.com>.*



To change the fault data into **PDF** or **Excel** format:

1. Click **Fault data**. The Fault Data pane shows on the right side of the window.
2. To filter the data in the Filter by Tester ID/ Machine ID field:
 - Select the specific testers from **Tester ID**.
 - Select the machines from **Machine ID**. You can export multiple machines.
 - Select the measurements by date from **Measurement ID**. You can export multiple measurements.
 - Select the start and end dates.

The faults selected by the IDs show in the fault list at the bottom of the screen.

Fault description	Fault severity	Measurement date
Gearbox Input Shaft Looseness Or Possible	Extreme	12/10/2013 11:20:23
Gearbox Ball Bearing Wear	Serious	12/10/2013 11:20:23
Indication Of Possible Coupling Wear Or Loc	Serious	12/10/2013 11:20:23
Motor Drive End Bearing Wear	Moderate	12/10/2013 11:20:23
Motor Free End Bearing Wear	Slight	12/10/2013 11:20:23
Motor Free End Bearing Looseness	Slight	12/10/2013 11:20:23

gbk122.jpg

3. To save as a PDF:
 - a. Click  .
 - b. Browse to a location and save PDF file.
4. To save as an Excel spreadsheet:
 - a. Click  .
 - b. Browse to a location and save the Excel file.
 - c. You can export multiple machines and dates, then cut and paste cells into a customized Excel chart to show trends over time.

Date:10/28/2014 7:50 PM

810 Vibration Tester Diagnostic Report

Device Serial Number : 16170026
Machine Setup Name : A1014 P-1201A
Measurement Date/Time : 12/10/2013 11:20:23

Drive Train

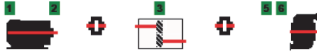

Maximum Peak : 4.0542 mm/sec at 15.0003 on 3T in High Range
1XRPM : 3630.545
Overall Vibration : 0.52 g (RMS)

Diagnosis

Fault description	Fault severity	Severity Score	Severity Scale
Gearbox Input Shaft Looseness Or Possible Pinion Damage	Extreme	96/100	
Gearbox Ball Bearing Wear	Serious	55/100	
Indication Of Possible Coupling Wear Or Looseness	Serious	52/100	
Motor Drive End Bearing Wear	Moderate	30/100	
Motor Free End Bearing Wear	Slight	7/100	
Motor Free End Bearing Looseness	Slight	3/100	

Recommendations

Recommendations	Priority	Priority Description
Inspect Gearbox Input Shaft Bearings And Pinion	4	Mandatory
Schedule Maintenance;Replace Gearbox Ball Bearings	3	Important
Monitor Motor Drive End Bearing For Increased Vibration	2	Desirable

Machine Setup

With the Viewer software, you can configure the Machine Setups on the PC and then export to the Tester. The setup sequence in the Viewer software closely follows that of the Tester.

Note

See “Operation” for complete instructions about Machine Setup.

Set Up a New Machine

You can make a new Machine Setup with the Viewer software. The Machine Setup wizard walks you through all the parameters to set up a vibration test. As you continue through the setup, it is important to have the correct data for each parameter. Setup fields will be different when the inputs are different.

To setup a new Machine:

1. Click **Machine Setup > Setup a new machine**. The Machine Setup pane shows on the right side of the window.

In the Drive Train field, a sample image shows the Machine Setup progress as the different parameters become known.

2. Fill in a name for the machine in the Machine Name field.
3. Click a motor type, AC or DC. Based on your selection, the fields are different as you continue.

Note

See “Operation” for complete instructions about Machine Setup.

4. Click Next to move through all the parameters.
5. Click **Finish** or  to save the Machine Setup. A prompt shows when the setup is done.

Note

Before you export the Machine Setup, make sure that the Tester to computer connection is good.

6. Click **OK**.
7. Click . A copy of the new Machine Setup is exported to the Tester. A prompt shows when the export is done.
8. Click **OK**.

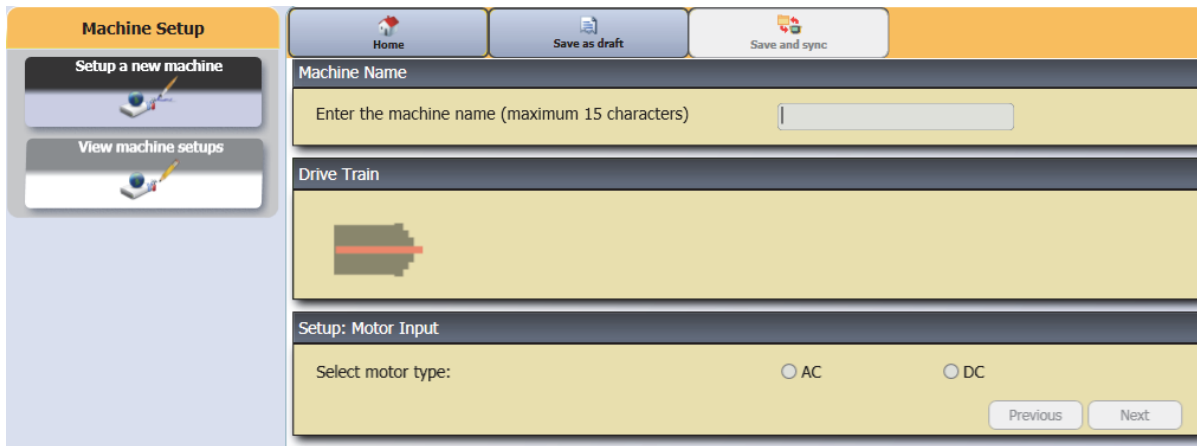

gbk99.bmp

View Machine Setups

You can see all the Machine Setups you make with the Viewer software in one window. The Viewer software also shows if these Machine Setups have been transferred to the Tester. You can Edit, Copy, Delete, and Export as a PDF the Machine Setups.

To open the setups window:

1. Click **Machine Setup > View Machine Setups**. The View Machine Setup pane shows on the right side of the window.

2. Click **PC desktop** (default selection) on the left side of the pane. The list of Machine Setups show with their Record Status (Machine Setup is complete or incomplete).
3. Click the Tester ID under **Testers**. The window shows all the Machine Setups transferred from the Viewer software to the Tester.

Note

Click the list header to arrange the items in ascending or descending order by date.









Table 5-3 is a list of the utilities for the View Machine Setup window.

The screenshot shows a software interface with a top navigation bar containing 'Home' and 'Delete ALL' buttons. On the left is a sidebar with 'PC desktop' and 'Testers' options. The main area displays a table with columns for Machine ID, Record status, Edit, Copy, Delete, and Export. The table contains six rows of machine records, all with a 'Complete' status.

	Machine ID	Record status	Edit	Copy	Delete	Export
<input type="checkbox"/>	M101	Complete				
<input type="checkbox"/>	M102	Complete				
<input type="checkbox"/>	M103	Complete				
<input type="checkbox"/>	M104	Complete				
<input type="checkbox"/>	M105	Complete				
<input type="checkbox"/>	M106	Complete				

gbk103.bmp

Table 5-3. View Machine Setup Utilities

Utility	Function
 (Edit)	Click to open the Machine Setup wizard and change the Machine Setup. Click Finish or  .
 (Copy)	You can make copies only of the Machine Setups from the Tester. Click to open the Machine Setup wizard and make a copy of a Machine Setup with a new name. As an option, you can change the setup parameters. Click Finish or  .
 (Delete)	Click to remove a Machine Setup. A confirmation prompt shows. Click Yes .
 (Export)	Click to make a PDF of the Machine Setup data.
 (Delete All)	Click the checkbox in front of multiple Machine Setups. Click  to remove the Machine Setups. Or, click the checkbox on the list header to choose all the Machine Setups at once. Click  to remove all the Machine Setups.

View Diagnosis

After you complete the vibration tests on a machine, you can import the diagnosis data to the computer and use the Viewer software to see an enhanced view of the data. The software filters let you set the parameters for the data view.

You can learn more about how to review the diagnostic reports and how to use the Viewer software with the training programs, guides, and videos on the Fluke website, www.fluke.com.

To view diagnosis data:

1. Import the diagnosis data, see *Import Diagnostic Data*.
2. Click **View Diagnosis**. The View Diagnosis pane shows in the window (sample diagnosis data is shown).

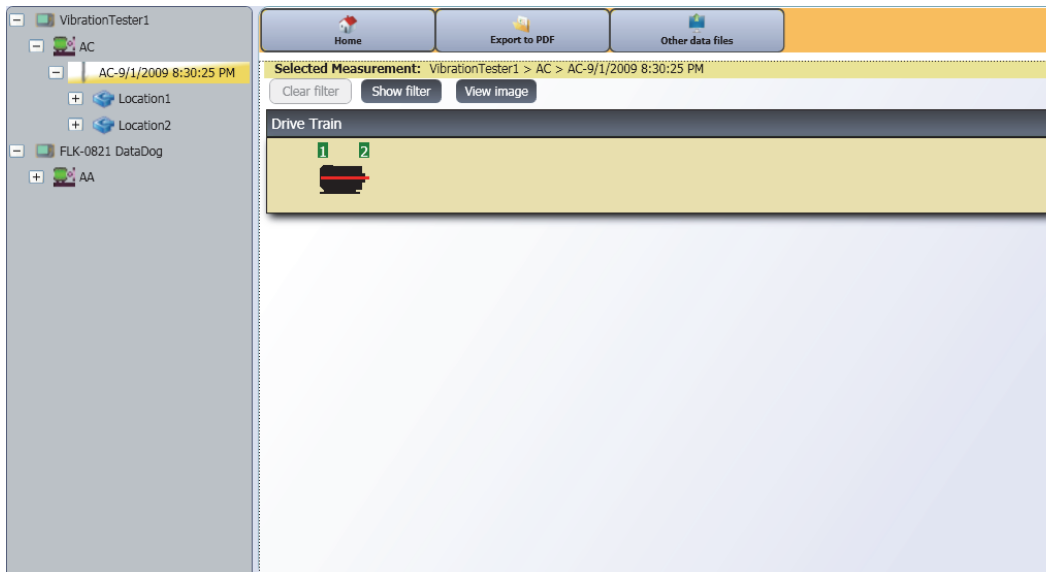

gbk104.bmp

The left side of the pane is a list of the available diagnosis data. This list is set up by the Tester name:

- Top level shows the Tester name
- Click + beside the Tester name to show the tests (Test ID) that use that Tester
- Click + beside the Test ID to show the Measurement ID
- Under the Measurement ID, you can find the Measurement location, the Time Waveform, and the Spectra for that location

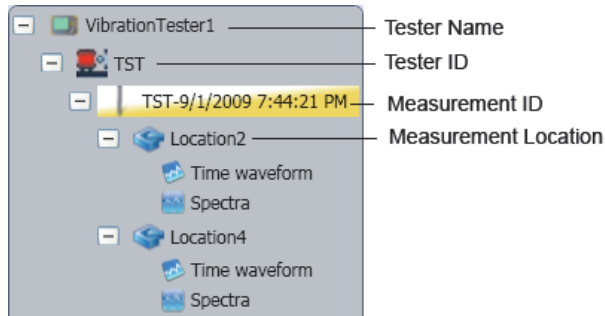

gbk105.bmp

3. Click **Clear Filter** to remove the filter selections and set to default.
4. Click **Show Filter** to open the Filters window. The **Tester ID** field shows the Tester Name.

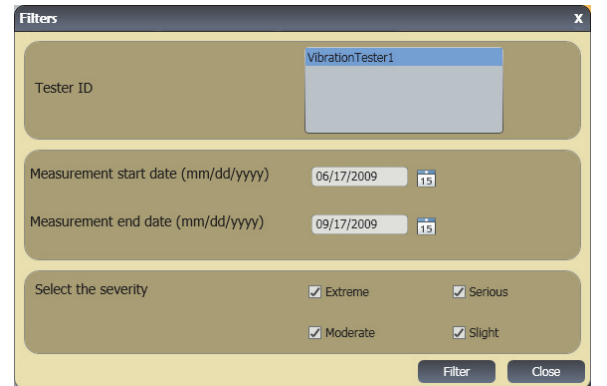

gbk106.bmp

5. Fill in the Start Date and the End Date. Or, click  and use the calendar to click on the date. This filter shows the list of measurements made in this time period.

6. In the Select the severity field, click the severity level as Extreme, Serious, Moderate, or Slight. This filter shows a list of the faults with that severity level.
7. After selecting the filter options, click **Filter**.

With any measurement selection, the **View Image** button appears. You use the **View Image** button to add the Thermographic image to the diagnosis data of a measurement.

To add a Thermal or jpg image:

1. Click View Image. A browse dialog box opens.
2. Click **Browse**.
3. Find the image (**JPEG** or **.IS2** image format) within the file structure.

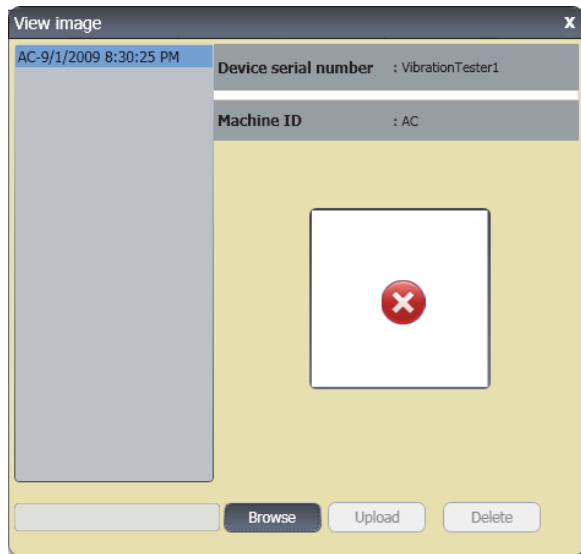

gbk107.bmp

4. Click **Upload** to add the image to the diagnosis data of the selected measurement. The **Drive Train** field shows the illustration of the tested machine. The **CitedPeaks Details** field shows the Faults from the Machine.
5. Click the drop down arrow on the Fault to see each cited peak and its Cited Peak number, Bearing, Axis (Axial, Radial, or Tangential), Vibration amplitude, Order, and Range (High or Low).
6. Click on a cited peak in the list to see its graph. The **Recommendations** field shows a prioritized list of troubleshooting tips for the faults.

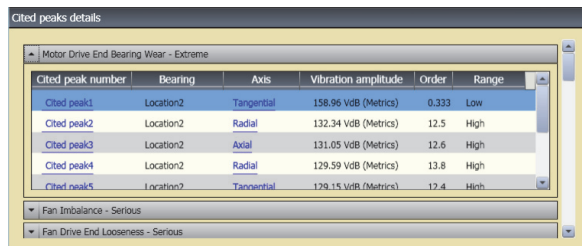

The screenshot shows a window titled "Cited peaks details" with a sub-header "Motor Drive End Bearing Wear - Extreme". It contains a table with the following data:

Cited peak number	Bearing	Axis	Vibration amplitude	Order	Range
Cited peak1	Location2	Tangential	158.96 VdB (Metrics)	0.333	Low
Cited peak2	Location2	Radial	132.34 VdB (Metrics)	12.5	High
Cited peak3	Location2	Axial	131.05 VdB (Metrics)	12.6	High
Cited peak4	Location2	Radial	129.59 VdB (Metrics)	13.8	High
Cited peak5	Location2	Tangential	129.15 VdB (Metrics)	12.4	High

Below the table, there are two expandable sections: "Fan Imbalance - Serious" and "Fan Drive End Looseness - Serious".

gbk108.bmp

To make a PDF of the diagnosis data:

1. Click . A dialog to save the PDF file opens.
2. Save the PDF file. A dialog to open the file shows on the display.
3. Select the file and click **Open**.

View Other Data Files

With the Viewer software, you can view the diagnosis details from other data files that uses the .mdf file format. To view backup data:

1. Click  Other Data Files. The Open dialog box shows on the display.
2. Browse to the **.mdf** database file that has the diagnosis data.
3. Find and open the **.mdf** database file. You can view the backup diagnosis data. See *View Diagnosis* for more instructions.
4. Click **Restore Main Database**.

Time Waveform

A time waveform is available for each test location. You must configure the system to save the raw time waveform. With advanced wave form analysis training, you can use pattern recognition in the time waveform to detect different problems.

To open the time waveform window:

1. Click on the location of interest.
2. Click **Time waveform** on the right side of the pane.

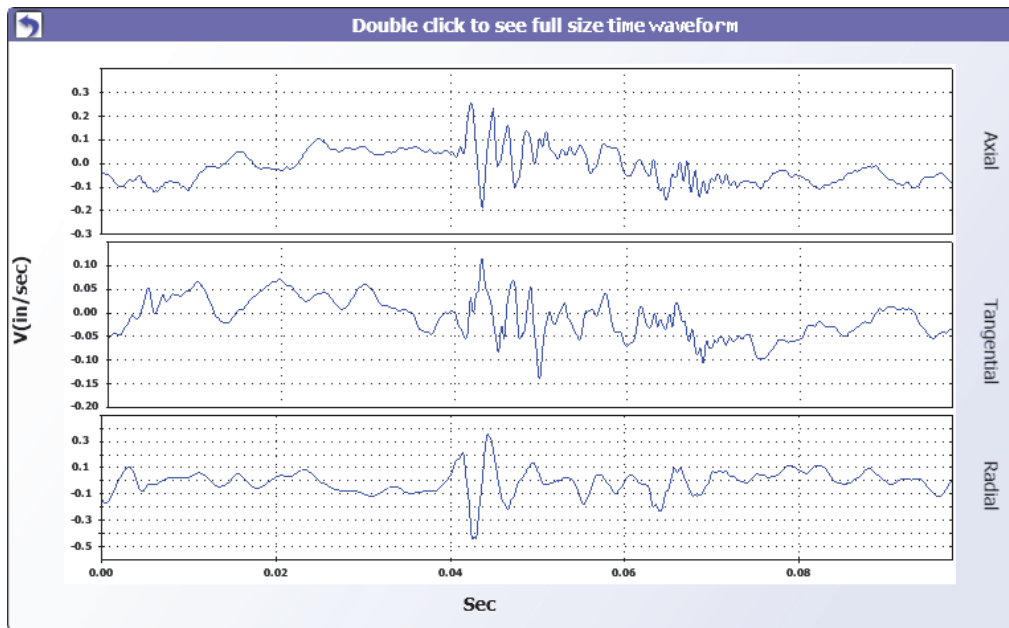

gbk114.bmp

To zoom in and zoom out the time waveform:

1. Click on the waveform image.
2. Rotate the scroll button of the mouse.

To change the units:

1. Click the X-axis label.
2. Click the Y-axis label.

To go back to the **View Diagnosis** menu, click .

Spectra

A 2-dimensional frequency plot, or spectra, is available for each test location. The plot compares the axial, tangential, and radial measurements.

To open the spectra window:

1. Click on the location of interest.
2. Click **Spectra** on the right side of the pane. The Spectra window opens.

The High range (or wide range) of frequency is within a spectrum of 0-100X. The Low range (or narrow range) of frequency is within a spectrum of 0-10X.

To zoom in and zoom out the data plot:

1. Double-click the Spectra image.
2. Rotate the scroll button of the mouse.

To change the units:

1. Double-click the X-axis label to change the amplitude units.
2. Double-click the Y-axis label to change the frequency units.

To go back to the **View Diagnosis** menu, click .

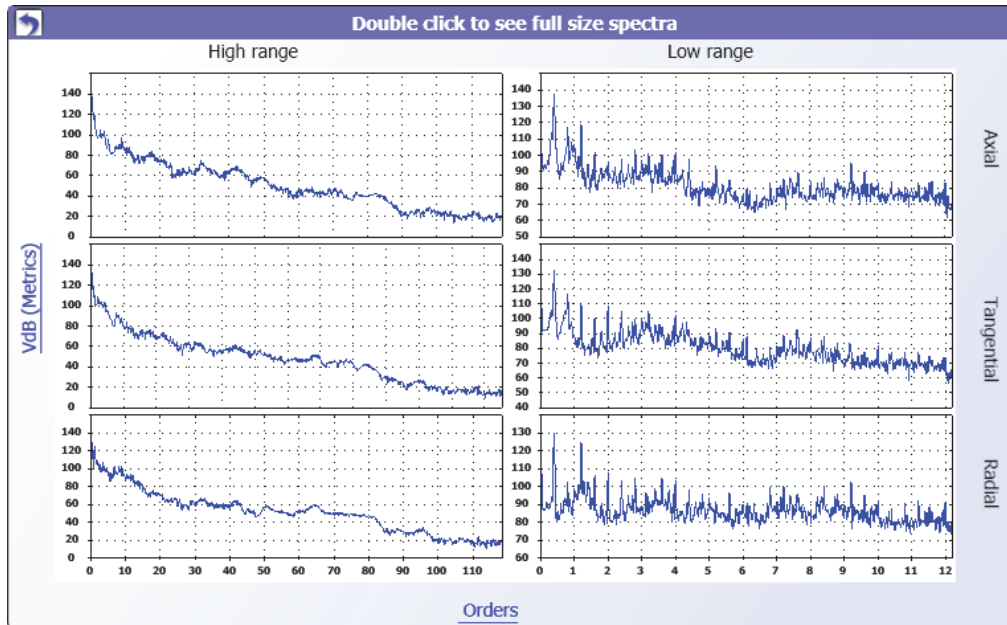

gbk109.bmp

Chapter 6

Maintenance

Title	Page
Introduction	6-3
How to Clean.....	6-3
Sensor Care.....	6-3
Battery Replacement.....	6-3
Vibration Tester Upgrades	6-5
How to Troubleshoot	6-6

Introduction

Minimum maintenance is necessary for the Tester. Do not hit, shake, or let the Tester fall as this can cause the setup parameters to change.

Caution

No part of the Tester is serviceable by the user. Do not attempt to open the Tester.

Caution

To prevent damage to the Tester or any performance loss, do not put the Tester in temperature extremes. The ambient operating temperature is between 32 °F and 122 °F (0 °C and 50 °C) with a maximum humidity of 90%.

How to Clean

Clean the external case of the Tester at regular intervals with a moist cloth and a weak detergent solution.

Caution

To prevent damage or performance loss, keep the Tester dry. Do not put the Tester into any liquid. The Tester is not waterproof.

Sensor Care

Clean the Sensor cable at regular intervals with a damp cloth and a weak detergent solution. Do not pull or push the cable when you attach or remove the Sensor.

When a vibration test is done, always replace the Sensor in the protective softcase.

Caution

To prevent damage to the inner piezoelectric sensor, do not hit, shake, or let the Sensor fall. A damaged Sensor decreases the diagnostic quality.

Battery Replacement

To replace the battery:

1. Find the battery on the Tester, see Figure 6-1.
2. Push the battery notch up and pull out to remove the battery.
3. To replace the battery, align the battery connector and push the battery into the battery slot.
4. Lightly push the battery until it locks into the slot.

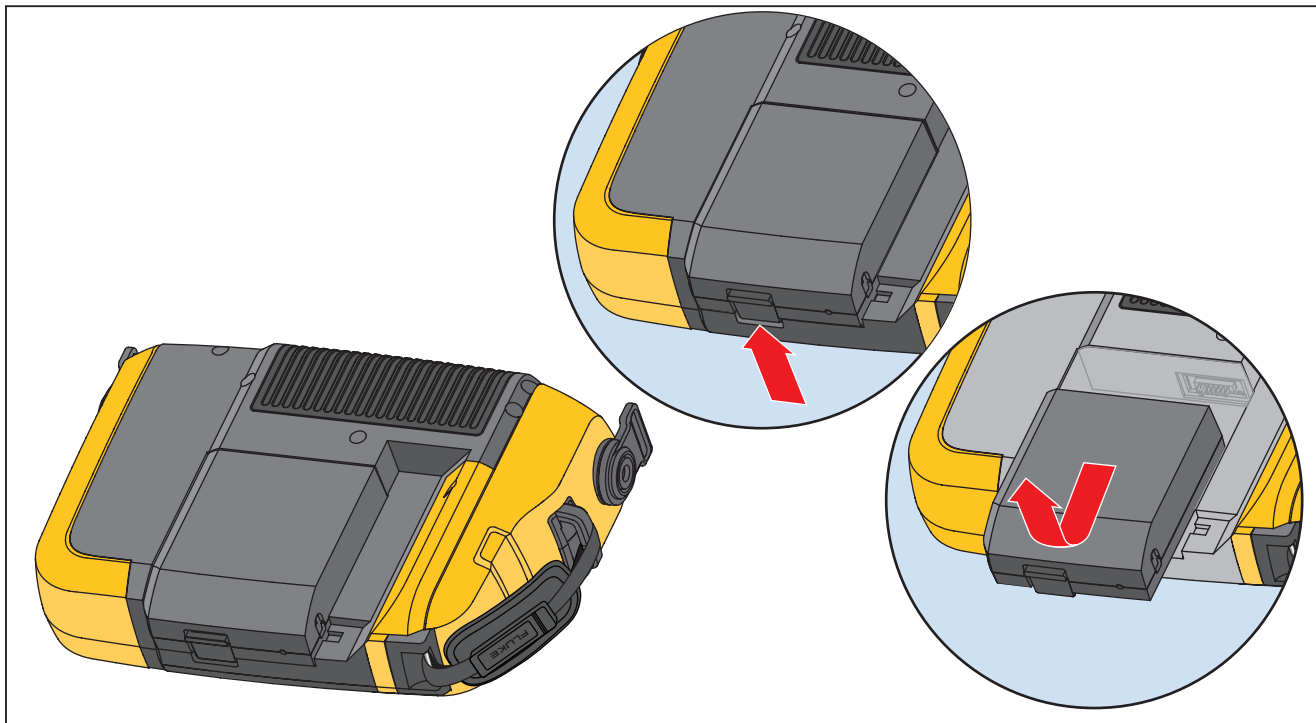

gbk12.eps

Figure 6-1. Battery Replacement

Vibration Tester Upgrades

Periodically, upgrades are available for the Tester. Contact Fluke for upgrade availability. If you have registered your Tester purchase, Fluke will send an upgrade notice to you automatically.

To upgrade the Tester:

1. Download the .CAB file for the Tester or diagnostic engine from the Fluke website www.fluke.com.
2. Launch the Viewer software application.
3. Click **Preferences**. The Preferences screen and submenus show on the display.
4. Click **Vibration Tester Upgrade**. The Software upgrade pane shows on the right side of the window.
5. Click **Browse** to select a .CAB file for the Vibration Tester. A window opens for you to browse the .CAB setup file.

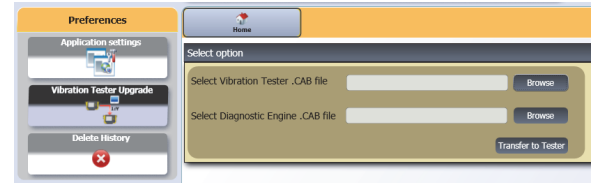

gbk110.bmp

6. Click **Transfer to Tester**.
7. Click **Browse** to select .CAB file. A window opens for you to browse the .CAB setup file.
8. Find the downloaded .CAB file within the file structure.
9. Click **Transfer to Tester**.
10. Restart the Tester. Tester upgrades with the latest software.

How to Troubleshoot

Table 6-1 is a list of problems, causes, and corrective actions for the Tester.

Table 6-1. Troubleshooting

Symptom	Cause	Corrective Action
Tester does not turn on.	The battery is fully discharged.	Connect the Tester battery to the ac adapter, connect to a power source, and charge the battery. If the problem continues, contact the Fluke Service Center for technical support.
Battery charge does not hold.	The battery is defective.	A fully charged battery operates the Tester for 8 hours (under normal operating conditions). Make sure that the battery is charged. If the battery quickly discharges, replace the battery. Contact the Fluke Service Center for a new battery.
Tester cannot connect with the Viewer Software.	The USB cable is not connected correctly.	Correctly connect the USB cable. See <i>PC Connection</i> .
	The USB cable is damaged.	Examine the USB cable for any damage. If you find damage, contact the Fluke Service Center for a replacement cable.
Front panel buttons / softkeys do not operate. Tester does not operate.		Push and hold the  button to stop the Tester. Restart the Tester. If the problem continues, contact the Fluke Service Center for technical support.

Appendix A

Frequently Asked Questions

This appendix is a compilation of the most frequently asked questions about the Vibration Tester. More information about the Tester is available at www.fluke.com.

FAQs - Setup

1. **Can I estimate values (RPM, hp, gear ratios, etc) when setting up the machine or must I provide exact information?**

In order to provide a proper diagnosis, the user should provide data that is as accurate as possible.

2. **How many characters can I use to create a machine name?**

The maximum machine name length is 15 characters.

3. **Why is RPM critical to receiving a proper diagnosis?**

Entering an accurate running speed (RPM) is critical to receiving a proper diagnosis. An accurate running speed helps the Tester accurately discern different fault conditions.

To obtain an accurate RPM value on a variable speed drive use the laser tachometer and reflective tape provided with the Tester or obtain the frequency value from the drive controller itself. To convert the frequency value to RPM, calculate the following:

$$\text{Hz} * 60 = \text{RPM}$$

4. **On belt or chain driven components, how can I estimate output RPM when I am unable to obtain a tachometer reading?**

Obtaining the RPM value using the laser tachometer is the preferred method for determining running speed. However, the output RPM value can be calculated using simple arithmetic. For simple reduction two-pulley (sheave) systems, use the following formula and solve for the RPM of the driven pulley:

$$\frac{\text{Diameter, driver pulley (sheave)}}{\text{Diameter, driven pulley (sheave)}} = \frac{\text{RPM, driven pulley (sheave)}}{\text{RPM, driver pulley (sheave)}}$$

5. **What happens if optional questions are not answered during the machine setup?**

To maximize the level of diagnostic confidence, more information is always better than less. Optional information, such as the number of gear teeth or number of pump vanes, can often be obtained through the component's user manual or direct from the manufacturer. Choosing to skip optional questions in the machine setup could potentially result in an overdiagnosis of the component's condition ("false positive").

6. **Do gearboxes require any special setup in the Tester?**

To diagnose gearbox faults properly, you must enter the shaft speeds, gear tooth counts or gear ratios.

If selecting the shaft speed method for single speed changers, it is critical to use the same entry method (manual or tachometer) on both input and output shafts.

For two or three-speed gearboxes, please refer to the gearbox documentation or machine label to determine gear ratios or gear tooth count.

7. **What kinds of machinery can I diagnose with the Tester?**

The Tester can diagnose most common types of rotating equipment, with the exception of turbines, centrifuges (purifiers), diesel/gas engines and generators. See the user's manual for a complete list of equipment. However, some equipment may be called by another name but could otherwise be setup within the Test. For example, a simple mixer within a food processing plant may have a drive train composed of a motor, coupling, gearbox and *propeller pump*. When considering whether a particular piece of equipment can be diagnosed with the Tester, break the equipment down into its most basic components and determine whether those components can be tested.

FAQs - Measurement

1. What are the effects of machine load and condition?

The vibration from a drive train may change depending on the load and the ambient temperature of the motor. The one exception to this rule is machines with misaligned driveshafts. It is recommended to take vibration measurements when the machine is running in a **steady state and at normal operating temperature**. For instance, taking measurements from a machine where the load regularly cycles or surges on or off is not ideal (i.e. compressors). In these instances, bypassing the process will be necessary to ensure accurate and consistent diagnoses. In the case of many compressors, the best opportunity to take measurements is when the tank is low, and the compressor is switched on. The compressor will run longer in order to fill the tank. Machines tested while still cold up may have significantly different vibration signatures than those at normal operating temperature as temperature impacts shaft alignment and operating clearances due to thermal expansion.

In the case of pumps, cavitation, air ingestion or discharge pressure will influence vibration readings and the diagnostic quality will be affected. Pumps should not be tested with the discharge valves closed; however, if they must be tested in a recirculating condition, the recirculating valve may be partially closed in order to achieve a normal discharge pressure.

For larger machines, the general rule is to warm up the machine for at least 30 minutes before taking a measurement.

2. How do I mount the sensor?

When using a magnetically mounted sensor, take care when attaching it to the test surface. The magnet could pull the sensor assembly from your hand and impact the test surface, introducing excessive shock that could permanently damage the sensor. Holding the sensor firmly, carefully roll the sensor onto the test surface to minimize the potential for impact.

3. Which mounting option is the best?

The Tester's diagnoses are largely dependent upon the quality of vibration signal it receives from the tested machinery. The method by which a sensor is mounted to the machinery directly affects the quality, accuracy and range of the signal.

In general, permanent mounts (i.e. stud, adhesive) yield the best results but are less convenient. They should be used with machinery that runs at high speeds and/or frequencies. This includes machinery with a speed changer (i.e. gearbox) resulting in an output shaft speed of greater than 5x the input shaft speed, machinery (i.e. vacuum pumps) where the driving unit is running greater than 6000 RPM, and centrifugal compressors, which typically include an integrated speed changer. Permanent mountings are also appropriate when desiring consistent data tracked over time. Magnet mounts are generally more convenient and faster, making them the most widely used for walkaround measurements, but some accuracy will be sacrificed.

4. Can I use a single axis sensor?

The Tester can work with a single axis sensor but it is recommended to use a tri-axial sensor to improve diagnostic quality and for convenience: using a tri-axial sensor can result in significant cost and time savings as 3 different channels are measured simultaneously, while single axis sensors measure one axis at a time. If a single axis sensor is connected, it is required to take at least two measurements from each bearing location to be able to diagnose data.

5. How can I select the right measurement locations?

If the drive train is horizontal: Place the sensor on the end, side, top or bottom of the equipment.

If the drive train is vertical: Place the sensor on the front, back, side, top or bottom of the components. For vertical drive trains, front, back and sides are essentially the same. The first placement will become the frame of reference for the others. For example, once a location is named "Front," the "Back" and "Side" locations become apparent. Make sure you use the same reference for future measurements.

It is recommended to take two measurements from each component in the drive train, if the driving motor has more than 40 hp (30 kW) and longer than 40 inches (102 cm) between bearings. For equipment with less than 40 hp and less than 40 inches between bearings, one measurement is sufficient.

Quick Tips:

- Locate the sensor as close as possible to the bearing, or on a solid structural member leading to the bearing
- Sensor cable position should be parallel or perpendicular to the drive shaft whenever possible.
- Avoid mounting the sensor on thin surface areas (i.e. fan shrouds) and cooling fins.
- Attach the sensor to a clean, flat, bare metal surface if possible. Thick layers of paint, grease, oil or other matter will reduce both the holding force of the magnet and the high frequency response of the sensor.
- For consistent diagnosis over time, it is important to place the tri-axial Sensors at the exact same orientation and location on a machine before you take a measurement.

- Do not take bearing measurements from a foundation or fabricated base.
- Do not mistake seal locations for a bearing measurement location on pumps.

Note

Refer to the Quick Reference Guide for further guidance on sensor locations.

6. Why is sensor orientation important?

The tri-axial sensor (provided with the Tester) can collect vibration signals from three different axes simultaneously. The orientation setup in the Setup routine helps the Tester properly correlate vibration signals to each of the three axes. Mounting the sensor in different locations and even changing the orientation by 90 degrees can cause a change in the directional signal picked up from one channel of the sensor. *Therefore, it is critical to ensure the sensor orientation setup in the Tester matches the actual orientation of the sensor as placed on the machinery.*

7. How do I orient the sensor?

The Tester uses the driveshaft (depicted as a thick red line in the display) as the primary frame of reference. Orient the sensor to the driveshaft using the sensor cable where it exits from the sensor, telling the Tester whether the cable is parallel or perpendicular to the shaft.

Quick Tip:

The first time you take a measurement, draw or paint a line on the machine indicating sensor measurement location, with an arrow indicating sensor orientation. This will aid in ensuring the consistency of future measurements.

8. Will the diagnosis be impacted if I cannot reach all the measurement locations?

You need to take *at least* one measurement from each component in the drive train for proper diagnosis. If a component is not tested (except belts and couplings), the Tester cannot diagnose the untested component.

9. When should I use the tachometer?

Using a tachometer is highly recommended for Variable Frequency Drives (VFDs) DC Motors and when RPM data is unavailable for regular drives. Reflective tape placed on the rotating equipment is required in order to capture readings with the tachometer.

10. What should I do when the Tester gives an accelerometer overload error?

Accelerometer overload is a common diagnostic system error. Usually a temperature transient or a loose sensor mounting can cause this error. To isolate the problem, first eliminate bad cables and improper sensor mountings. If the problem is still not resolved after eliminating these issues, please contact your Fluke service center.

FAQs - Diagnosis

1. How does the Tester diagnose the problems and how accurate are the diagnoses?

Once the setup and measurement information is collected, the onboard diagnostic system analyzes the data using a set of powerful algorithms. Using a database of similar machines *with no known faults*, the diagnostic system compares the tested machine's setup and newly acquired vibration data to similar machines in the database.

Diagnostic quality is largely based upon the quality and quantity of the machine setup and data provided to the Tester. Proper component descriptions coupled with proper sensor placement and orientation, accurate running speed measurements and answering all optional questions in the machine setup will contribute to higher confidence in the final diagnosis. While accuracy can be provided for the Tester's ability to collect data (see Electrical Specifications), many variables come into play to define a reliable accuracy specification for the Tester's diagnostic capability. However, in independent testing, the diagnostic capability of the Tester is similar to that of an experienced vibration analyst.

The diagnoses are based on experience with similar machines. The Tester is part of an overall decision-making process and should be used alongside good judgment and knowledge of the specific machine tested before taking specific repair actions.

2. How should the severity scale be interpreted? How long do I have before failure?

The severity scale is based on the intensity of the machine fault at the time of measurement. It is not an indicator of time to machine failure. As conditions change, the severity may change, even appear to improve (for example, immediately after lubrication). However, over time, conditions will worsen with normal machine wear and tear. ***Time to failure will vary depending on the equipment type, age, machine load, environmental conditions, and other variables.*** It is not possible to correlate each severity level with a certain time to failure. Follow the recommended actions for each severity level to avoid failure. In general, the scale may be interpreted as follows:

- **Slight** No repair action is recommended. Monitor the machine and retest after regular machine planned maintenance to verify maintenance was performed correctly.
- **Moderate** (Months, even up to a year) – Repair action may be needed in the future. A machine failure is possible, so plan accordingly. Increase the frequency of vibration testing on this equipment and review spare parts availability.
- **Serious** (Weeks) – Repair action may be needed before the next planned downtime. There may be other physical evidence of the fault in terms of noise or higher bearing temperatures. Retest the machine within a short period to confirm finds. Limit the run time of the machine, if possible, and determine a fault progression trend to prevent additional component failure.
- **Extreme** (Days) – Consider shutting down the equipment and taking repair action **now** to avoid catastrophic failure. There is likely other physical evidence of the fault in terms of noise, higher bearing temperatures or visible movement. Retest the machine within a short period to confirm finds.

3. The Tester says “serious” or “extreme” but there is no indication of failure, what should I do?

For extreme faults, users should be able to sense impending failure through excessive temperature, noise or visible movement. If there are no physical indications of failure, it is recommended to check the machine setup inputs in the Tester and retake the measurement. Improper machine setup, incorrect running speed (RPM) or improper measurement technique may result in an inaccurate diagnosis. The diagnostic quality is directly related to the quality and quantity of information provided to the Tester.

4. The Tester says “slight” or “moderate,” but there appears to be extreme vibration levels, what should I do?

There are certain situations like a machine installed on a flexible foundation where excessive vibration can be detected. This type of vibration is not necessarily bad, but is rather by design.

It is still recommended to check the machine set up input values and retaking the measurement if there is any doubt with the diagnostic results.

5. What are some of the causes of bad data and diagnosis?

The following will result in poor data collection and inaccurate diagnoses:

- Improper speed input
- Improper machine setup
- Thermal transients, machine not up to normal operating temperature
- Sensor overload, most often from not allowing sensor to equalize in temperature prior to collecting data
- Improper measurement locations
- Taking measurements from a machine that is cycling or surging on and off

Confirm machine setup values and take measurements again.

6. What should I do when the Tester diagnoses more than five serious or extreme faults?

If the Tester diagnoses more than five serious or extreme faults, it is highly likely that a setup input value is incorrect and the Tester is possibly providing misleading diagnoses due to incorrect information. Re-check the machine setup inputs, specifically RPM values (if the exact speed is not known, use the tachometer or view the drive control panel). Retake the measurement and re-analyze the data.

7. I would like to learn more about advanced vibration consulting services. Any recommendations?

Fluke has partnered with a premier service provider, Azima DLI, to provide advanced vibration consulting services. Find them on the web at www.azimadli.com or contact them directly:

Customer Support

Azima DLI

1050 NE Hostmark Street, Suite 101

Poulsbo, WA 98370

USA

Voice: (+1) 360-626-0111 (05:00 – 4:30 PM Pacific Time Zone)

Fax: (+1) 360-626-0041

Email: support@AzimaDLI.com

Appendix B

Warning and Error Messages

Table B-1 is a list of the warning and error messages from the Tester. Table B-2 is a list of the warning and error messages from the Viewer software.

Table B-1. Vibration Tester Warning and Error Messages

Display Message	Description
Invalid RPM	The RPM is out of range (the RPM range is 200 to 12000)
Tachometer not connected	The Tester cannot find the Tachometer. See “How to Connect the Tachometer” and make the connections.
Tachometer laser not ON	Tachometer laser is off. Push the Tachometer power button to on.
Failed to POWER ON Tachometer	Power from the Tester is necessary for the Tachometer to operate. Make sure that the cable connection is good. If the problem continues, contact Fluke for technical support.

Table B-1. Vibration Tester Warning and Error Messages (cont.)

Display Message	Description
Failed to read RPM from Tachometer	Tachometer cannot read the RPM of the machine. Follow the correct procedure to measure the RPM.
Sensor not connected	The Tester cannot find the Sensor. See "How to Connect the Sensor" to make the connections.
Failed to read Sensor type	The Tester cannot find the Sensor. See "How to Connect the Sensor" to make the connections.
Cable is open	The Tester cannot find the Sensor. See "How to Connect the Sensor" to make the connections.
Cable is short	Cable or Sensor is bad. Change the cable or Sensor. Contact Fluke for a new Sensor.
Data acquisition failed	The Sensor mount method or measurement procedure is incorrect. See "How to Take a Measurement" and "Sensor Mounting" for the correct procedure.
Measurement storage failed	The Tester memory is full. Make a data backup with the Viewer software and remove data from the Tester memory.
Measurement time out	Allowed measurement time has been exceeded. The time to make a measurement is 30 minutes with triaxial Sensor and 45 minutes with single-axis Sensor. Make a new measurement within the allowed time.

Table B-1. Vibration Tester Warning and Error Messages (cont.)

Display Message	Description
Invalid measure	The Tester cannot collect sufficient measurement data. Install the Sensor correctly, make sure that the orientation of the Sensor is correct, and make a new measurement.
Diagnosis failed	The Tester cannot diagnose the measurement data. Make the measurement again. If the problem continues, contact the Fluke Service Center for technical support.
Failed to perform self test	This message shows during a self-test. The Tester is defective, contact the Fluke Service Center for technical support.
Calibration past due. Last calibration done on <Date>	Calibrate the Sensor. Contact the Fluke Service Center for technical support.
Set today's date	The current date in the Tester is before the calibration date. Set the Tester to the current date. See "Tester Settings."
Battery low, please re-charge	Connect the Tester battery to the ac adapter, connect into a power source, and charge the battery. See "How to Charge the Battery."
Sensor failure	This message shows during the self-test. The Sensor is defective. Contact the Fluke Service Center for technical support.
Tachometer failure	This message shows during the self-test. The Tachometer is defective. Contact the Fluke Service Center for technical support.

Table B-1. Vibration Tester Warning and Error Messages (cont.)

Display Message	Description
Failed to perform self test	This message shows during the self-test. The Tester is defective. Contact the Fluke Service Center for technical support.
Data transfer not successful	This message shows if the Tester cannot connect to the Viewer software. Make sure that the connection is good between the Tester and computer.
Contact Fluke Service Center	An error occurred in the Tester. Turn the Tester off and then on. If the message is frequent, contact the Fluke Service Center for technical support.

Table B-2. Viewer Software Warning and Error Messages

Display Message	Description
Application encountered an error.	An error occurred in the Viewer software. Restart the Viewer software application.
Invalid file	The Viewer software cannot read the file type.
Installation file format is wrong	The upgrade file is defective or invalid.
Tester connection is lost	This message shows if the connection breaks between the computer and the Tester during data transfer. Correctly connect the USB cable.

Appendix C

Glossary

Acceleration. The rate of change of velocity, often depicted as “g’s” or in “mm/s²” in the metric system or “in/sec²” in the English system. Acceleration is not constant but will vary through the vibration cycle, reaching maximum levels as velocity reaches its minimum. This is typically when a particular mass has decelerated to a stop and is about to begin accelerating again.

Accelerometer. A transducer whose electrical output responds directly to acceleration. Accelerometers typically cover a much wider frequency range, allowing them to pick up signals not present with other types of transducers. Due to their frequency range, accelerometers are ideal for most types of rotating equipment, making them the most commonly used transducer for vibration measurements.

Alignment. A condition where components within a drive train are parallel or perpendicular, according to design requirements. The Tester can diagnose misalignment conditions where these components are no longer aligned according to design requirements, causing excessive bearing wear and power consumption in the machine.

Amplitude. The size or the magnitude of the vibration (displacement or velocity or acceleration). Peak-to-peak, zero-to-peak or Root Mean Square (RMS) can be used to express velocity terms. In general, “Peak-to-peak” is used for displacement, “Zero-to-Peak” is used for velocity and RMS is used for acceleration. In the Tester’s diagnostic details, amplitude indicates the magnitude of each cited peak in velocity terms.

Axial. One of the three vibration axes (Radial, Tangential and Axial), the axial plane is parallel to the centerline of a shaft or turning axis of a rotating part.

Balancing Resonance Speed(s). A rotating speed that corresponds to a natural resonance frequency.

Balanced Condition. For rotating machinery, a condition where the shaft's geometric centerline coincides with the mass centerline.

Balancing. A procedure for adjusting the radial mass distribution of a rotor so that the mass centerline approaches the rotor geometric centerline.

Blocking. The installation of a permanently affixed mounting block is known as "blocking" a machine.

Cited Peak. An abnormal vibration magnitude/level identified (or cited) by the Fluke 810 diagnostic engine. Cited Peaks are marked with red in the Tester and in the Viewer Software. Each fault diagnosed can be related to several cited peaks.

CPM. Cycles per minute. Cycles per minute is a measure of the number of times a particular event occurs within a one minute period. Used as the horizontal axes of the spectra and time waveform plots within the Tester.

Displacement. When measuring machinery vibration, displacement represents the actual distance the vibration causes the part in question to move. It is measured in thousandths of an inch (mils) in the English system and in millimeters (mm) in the metric system.

Frequency. The number of events that occur within a fixed time period, frequency is also calculated as the reciprocal of time (for example, one divided by the time interval). Frequency is typically expressed in terms of Hertz (Hz), but can also be expressed as cycles per minute (cpm) or revolutions per minute (RPM) when multiplying Hz times 60. It can also be represented as multiples of turning speed, or "orders," where frequency in RPM is divided by the turning speed of the machine.

Frequency Domain. Since vibration exists within the time domain, a vibration signal is represented as a time wave form if viewed on an oscilloscope. If plotted, the time waveform would represent a plot of amplitude vs. time. If the waveform were transformed to the frequency domain, the result would be a spectrum representing a plot of amplitude vs. frequency.

Imbalance. A condition on rotating equipment where the center of mass does not lie on the center of rotation. Imbalance can severely reduce bearing life as well as cause undue machine vibration.

Looseness. Mechanical looseness can be either of two types: rotating and non-rotating. A rotating looseness is caused by excessive clearance between rotating and stationary elements of the machine such as in a bearing. Non-rotating looseness is a looseness between two normally stationary parts, such as a foot and a foundation, or a bearing housing and a machine.

Misalignment. In machines, perfect alignment occurs when the centerline of two coupled shafts coincide. When they do not coincide, misalignment exists. Angular misalignment is when the centerline of the two shafts intersect but are not parallel. Parallel misalignment is when the centerline of the two shafts are parallel but not concentric.

Mounting Pad. Mounting pads (bronze or stainless steel) can be placed at appropriate measurement locations on machines using an industrial adhesive. The triaxial accelerometer is attached to these pads for data collection. The pad ensures a good transfer of vibration data to the transducer by providing a strong and consistent mounting location.

Orders. With regards to rotating equipment, orders are multiples or harmonics of the running speed (or associated reference component). For example, 1X means “one times running speed.”

Piezoelectric Element. Any transducer (sensor) that uses a piezoelectric substance as an active element. Examples are force transducers, accelerometers, pressure transducers, and phonograph pickup cartridges.

Radial. One of the three vibration axes (Radial, Tangential and Axial), the radial plane represents the direction from the transducer to the center of the shaft on rotating equipment. For typical horizontal machines, radial equals the vertical axis. For horizontal machines radial

refers the horizontal axis upon which the accelerometer is attached.

Range (Frequency). Frequency range of data collection. Hi indicates the High or wide range of frequency within a spectrum (i.e. 0-100X). Lo indicates the Low or narrow range of frequency within a spectrum (i.e. 0-10X).

Running Speed. The speed, usually expressed in revolutions per minute (RPM), at which a rotating machine runs. It may also be expressed in Hz by dividing RPM by 60.

Sensor. Transducer, or accelerometer, whose output is directly proportional to acceleration. Piezoelectric elements are most commonly used to produce the Sensor's output.

Signature. The signature, usually called the vibration signature, is the overall vibration pattern of a machine. It is said that the vibration signature contains more information about the machine than any other nondestructive test can discover.

Spectrum. Plural Spectra. The plot of the vibration signal's amplitude (y-axis) against frequency (x-axis), also referred to as the “vibration signature,” an “FFT” or “spectral plot”. Vibration signals can be transformed from the time domain (amplitude against time) to the frequency domain (amplitude against frequency) by using the Fast Fourier Transform (FFT) method. A spectra simplifies vibration data interpretation as certain vibration

amplitudes can be closely related to the running speed of the machinery. The diagnostic technology in the Tester identifies the mechanical problems depicted in the spectra and cites the abnormal magnitudes.

Tachometer. A device for indicating rotation speed.

Tangential. One of the three vibration axes (Radial, Tangential and Axial), the tangential plane is positioned 90 degrees to the radial plane, running tangent to the driveshaft. For typical horizontal machines, tangential equals the horizontal axis. For typical vertical machines tangential equals the second horizontal axis perpendicular to the mounting of the accelerometer.

TEDS. A Transducer Electronic Datasheet (TEDS) is a technology that enables communication of the Sensor type to the Tester. TEDS works with the Tester to ensure the Sensor performs at its specified sensitivity, ensuring optimal performance, and reminds the user when the Sensor needs to be calibrated.

Time Waveform. The plot of a vibration signal in the time domain with the signal's amplitude (y-axis) against time (x-axis). The time waveform represents the signal as directly captured from the Sensor. The Tester does not store time waveforms unless users opt to capture them within the Tester's settings. Time waveforms can only be viewed in the Viewer software and they can be exported to a file if further analysis is desired.

VdB (Velocity in Decibels). VdB is a logarithmic scale referencing 0 VdB=10E-8 meter per second. This scale is used for US measurements.

VdB* (Velocity in Decibels). VdB* is a logarithmic scale referencing 0 VdB=10E-9 meter per second. This scale is used for SI/metric measurements.

Velocity. Velocity is the rate of change in position, measured in distance per unit of time. When measuring vibration signals, velocity also represents the rate of change in displacement and is expressed in inches (in) or millimeters (mm) per second.

VFD (Variable-Frequency Drive). A VFD is a system for controlling the rotational speed of an alternating current (AC) electric motor by controlling the frequency of the electrical power supplied to the motor.

Vibration. Vibration is the oscillation of a point, an object, or a part of an object around a fixed reference, or rest, position. An object can vibrate as a unit, in which case it is called "whole body vibration", or, as is usually the case, an object can vibrate in a complex way where it deforms and different parts of it vibrate at different frequencies and amplitudes.