

Product Data Sheet

DX43420

RK Range



Routing components for rigid protective conduits with IP40 and IP67 protection degree.

Colour	Grey RAL 7035	IP degree	IP65
Conduits Ø (mm)	20	Sheath Ø (mm)	20
Type of material	Halogen-free in compliance with EN 60754-2	Electrocod	21221

DIMENSIONAL

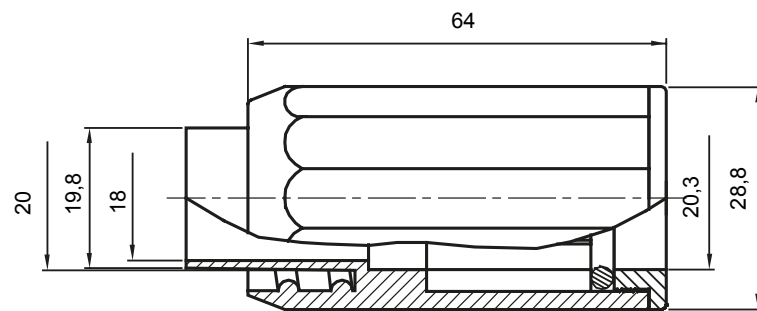
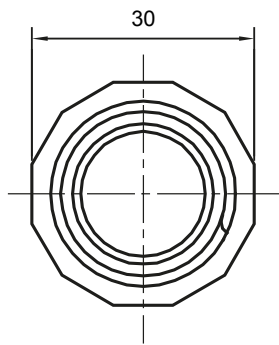

TECHNICAL SYMBOLOGY

IP

HF
HALOGEN FREE

IP65

STANDARDS/APPROVALS

