

Product Data Sheet

GW10191

CHORUSMART - Domestic range



Wide range of control devices, sockets for power supply (conforming to national and international standards) signal pick-up, climate control, comfort management, technical alarm signalling and emergency lighting management. The ChoruSmart modular devices are available in five colours, glossy white, satin white, natural beige, satin black and lacquered titanium and in various sizes from 1/2, 1, 2 and 3 modules. Thanks to the mounting supports for rectangular, square and round boxes, endless combinations can be created with the ChoruSmart range of plates.

Category	Push-button with name plate	Type	Name plate
Colour	Glossy white	Description	1P NO - 10A
Voltage	250 V ac	Standard	EN 60669-1
Resistance at test voltage	2000 V at 50 Hz for 1 minute	Insulation resistance	> 5 MOhm
Wiring terminals	With screw	Prolonged operation switch (no.of position changes)	40.000 at In 250 V ac cosφ=0,6
Lamp	Cartridge lamp S6x36 mm	Thermo-pressure with ball	125 °C
Glow Wire Test	850 °C	Lamp voltage	12-24V ac/dc
Terminal grip on cable traction	> 50 N	Lamp power	2 W
Terminal tightening capacity stranded cables (mm ²)	min. 0,75 - max. 2x4	Terminal tightening capacity solid cables (mm ²)	min. 0,5 - max. 2x2,5
No. modules	2	Material	Technopolymer
Electrocod	0130		

DIMENSIONAL

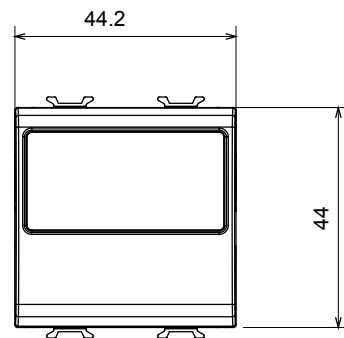
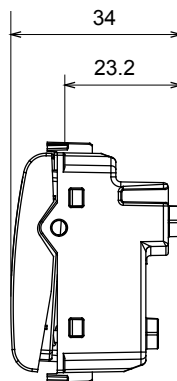
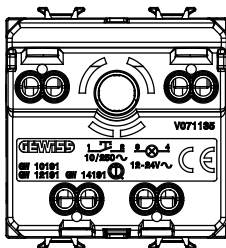

TECHNICAL SYMBOLOGY



STANDARDS/APPROVALS

