

Universal rotary dimmer insert for LED lamps

Operating instructions

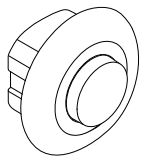

SBD200LED Art. no. WDE006937, WDE007137

For your safety

DANGER
Risk of serious damage to property and personal injury, e.g. from fire or electric shock, due to incorrect electrical installation.

Safe electrical installation can only be ensured if the person in question can prove basic knowledge in the following areas:

- Connecting to installation networks
- Connecting several electrical devices
- Laying electric cables

These skills and experience are normally only possessed by skilled professionals who are trained in the field of electrical installation technology. If these minimum requirements are not met or are disregarded in any way, you will be solely liable for any damage to property or personal injury.

DANGER
Risk of death from electric shock.
 The outputs may carry an electrical current even when the device is switched off. Always disconnect the fuse in the incoming circuit from the supply before working on connected loads.

Getting to know the universal dimmer

With the Universal rotary dimmer insert for LED lamps (hereafter referred to as **dimmer**) you can switch and dim ohmic, inductive or capacitive loads:



Dimmable LED lamps



Incandescent lamps (ohmic load)



230 V halogen lamps (ohmic load)

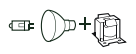

Low-voltage halogen lamps with dimmable wound transformer (inductive load)

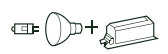

Low-voltage halogen lamps with electronic transformer (capacitive load)

The dimmer automatically recognises the connected load. It is overload-proof, short-circuit-proof, protected from overheating and it has a soft-start function.

You can set the dimming range and adjust the operating mode (from trailing edge phase to leading edge phase).

CAUTION
The dimmer may be damaged!

- Always operate the dimmer according to the technical data provided.
- Connected dimmers may be damaged if you connect a combination of loads (inductive and capacitive) at the same time.
- The dimmer is designed for sinusoidal mains voltages.
- If transformers are used, only connect dimmable transformers to the dimmer.
- Dimming socket outlets is prohibited. The risk of overload and connecting unsuitable dimmers is too high.
- If a terminal is used for looping, the insert must be protected with a 10 A circuit breaker.

Installing the device

i If you do not install the dimmer in a single, standard flush mounting box, the maximum permissible load is reduced due to the decreased heat dissipation:

Load reduced by	When installed
25 %	In cavity walls* Several installed together in combination*
30 %	In 1-gang or 2-gang surface-mounted housing
50 %	In 3-gang surface-mounted housing

* If several factors apply, add the load reductions together.

Wiring the insert

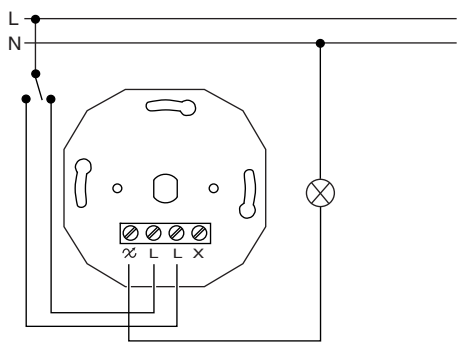

Installing the dimmer

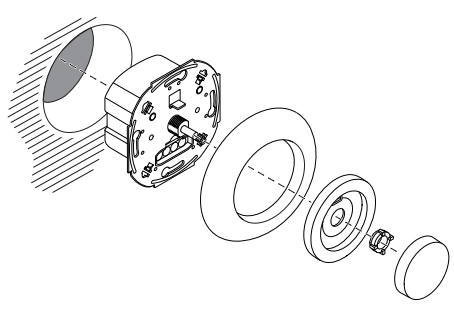

Setting the device

Dimming range

The dimming range of the dimmer can, if necessary, be adapted to the dimming range of lamps from different manufacturers.

Setting the dimming range

i Depending on the dimming range of the lamp, malfunctions may occur for values near the maximum and minimum brightness. (Refer to the chapter "What should I do if there is a problem?")

Setting the minimum and maximum brightness value

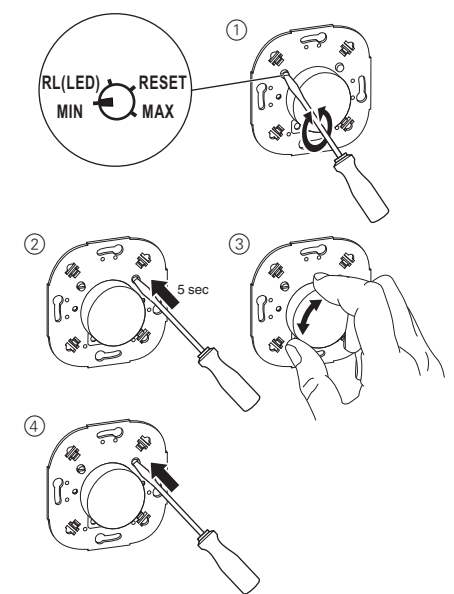

- ① Set the potentiometer to MIN/MAX.
- ② Hold the micro button down for 5 seconds. (The lamp lights up briefly.)
- ③ Turn the rotary knob to the desired minimum/maximum brightness.
- ④ Press the micro button briefly. The selected brightness is saved as the minimum/maximum brightness and the set mode is closed.

Operating mode

The default setting of the dimmer is the RC mode. The dimmer recognises the connected load automatically, however this can lead to malfunctions in some lamps (see manufacturer's specifications). In this case you can adjust the operating mode.

Switching the operating mode to RL LED mode

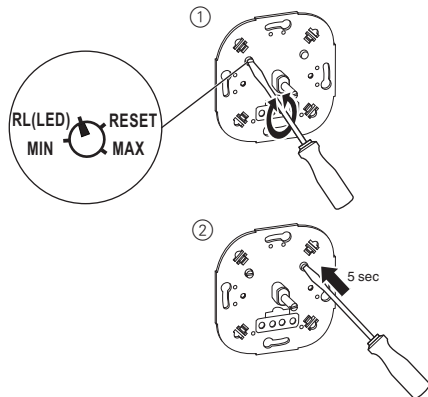

- ① Set the potentiometer to RL(LED).
- ② Hold the micro button down for 5 seconds. (The lamp lights up briefly.)

The operating mode is switched to "leading edge phase for LED lamps" (RL LED mode) and the minimum/maximum brightness value is reset.



In the operating mode "leading edge phase for LED lamps" (RL LED mode), LED lamps can only be connected at up to 10 % of the maximum permissible dimmer load.

Operating the device

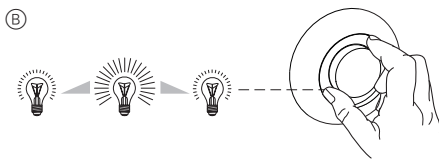
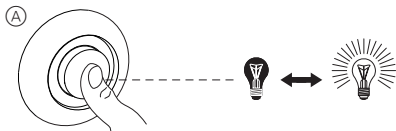

- A Press the rotary knob: the connected lamps are switched-on or off.
- B Turn the rotary knob either clockwise or anti-clockwise: the connected lamps are dimmed brighter or darker.

Resetting to default mode

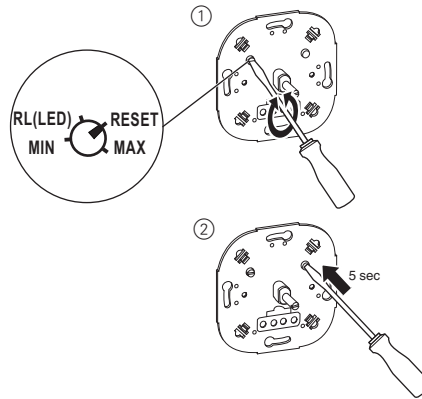

- ① Set the potentiometer to RESET.
- ② Hold the micro button down for 5 seconds. (The lamp lights up briefly.)

The operating mode is switched to "trailing edge phase" (RC mode) and the minimum/maximum brightness value is reset.

What should I do if there is a problem?

The dimmer dims down regularly during operation and cannot be dimmed up again.

- Allow the dimmer to cool down and reduce the connected load.

The load cannot be switched back on.

- Allow the dimmer to cool down and reduce the connected load.
- Rectify any possible short circuits.
- Renew defective loads.

The load is dimmed to the minimum brightness.

- The circuit is overloaded. -> Reduce load.
- The circuit falls short of the minimum load. -> Increase load.
- Dimming range is incorrect. -> Reduce maximum brightness value.

The load flickers at minimum brightness.

The circuit falls short of the minimum possible brightness value.

- Increase minimum brightness value (set dimming range).

The load flickers continuously.

Incorrect operating mode set.

- Switch operating mode to "leading edge phase for LED lamps" (RL LED mode).
- Alternatively, reset operating mode to default.

The load can only be dimmed slightly.

- Set dimming range.
- Switch operating mode to "leading edge phase for LED lamps" (RL LED mode).

Technical data

Nominal voltage:	AC 230 V ~, 50/60 Hz
Switching capacity:	
LED lamps	
(RC mode):	4-200 VA
LED lamps	
(RL LED mode):	4-40 VA
Incandescent lamps:	4-400 W
230 V halogen lamps:	4-400 W
LV halogen lamps with dimmable	
wound transformer:	4-400 VA
LV halogen lamps with electronic transformer:	4-400 VA
Neutral conductor:	Not required
Connecting terminals:	Screw terminals for max. 2.5 mm ²
Protection:	16 A circuit breaker
Properties:	<ul style="list-style-type: none"> • Short-circuit-proof • Overload-proof • Soft start • Resistant to overheating • Automatic load detection



Dispose of the device separately from household waste at an official collection point. Professional recycling protects people and the environment against potential negative effects.

Schneider Electric Industries SAS

If you have technical questions, please contact the Customer Care Centre in your country.

schneider-electric.com/contact