

PRODUCT DATASHEET

PANEL VAL 600 36 W 6500 K WT

PANEL VALUE 600 | Square recessed panel luminaires, 600 x 600 mm

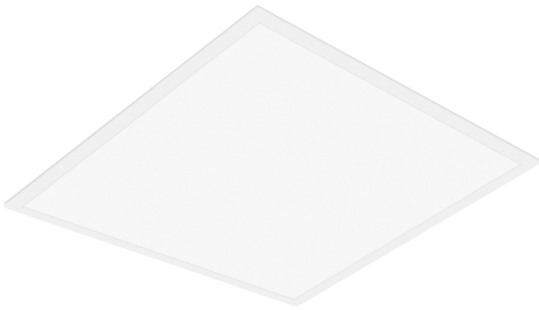

Areas of application

- Direct replacement for luminaires with fluorescent lamps
- Offices, conference rooms
- Reception areas, foyers, corridors, elevators
- Suitable for recessed ceiling systems with grid size of 600 x 600 mm

Product benefits

- Value for money luminaire
- Low flicker light thanks to special electronic control gear
- Energy savings thanks to system efficacy of up to 100 lm/W
- External driver for extended flexibility and easy installation
- Versions with DALI ECG available

Product features

- Lifetime (L70/B50): up to 50,000 h (at 25 °C)
- Extruded aluminum frame
- Polystyrene diffuser



TECHNICAL DATA

Electrical data

| | |
|--|---------------------|
| Nominal wattage | 36.00 W |
| Nominal voltage | 220...240 V |
| Mains frequency | 50...60 Hz |
| Nominal current | 170 mA |
| Inrush current | 10.4 A |
| Inrush current time T_{h50} | 200 μ s |
| Max. no. of lum. on circuit break. B16 A | 19 |
| Max. no. of lum. on circuit break. C10 A | 19 |
| Max. no. of lum. on circuit break. C16 A | 30 |
| Power factor λ | > 0.90 |
| Total harmonic distortion | < 15 % |
| Protection class | II |
| Operating mode | External LED driver |

Photometrical data

| | |
|--|--------------------|
| Luminous flux | 3600 lm |
| Luminous efficacy | 100 lm/W |
| Color temperature | 6500 K |
| Light color (designation) | Cool Daylight |
| Color rendering index Ra | > 80 |
| Standard deviation of color matching | 5 sdc _m |
| Luminous intensity | - |
| Low flicker | Yes |
| Flickering metric (Pst LM) | - |
| Stroboscope effect metric (SVM) | - |
| Photobiological safety group acc. to EN62778 | RG0 |
| Beam angle | 120 ° |

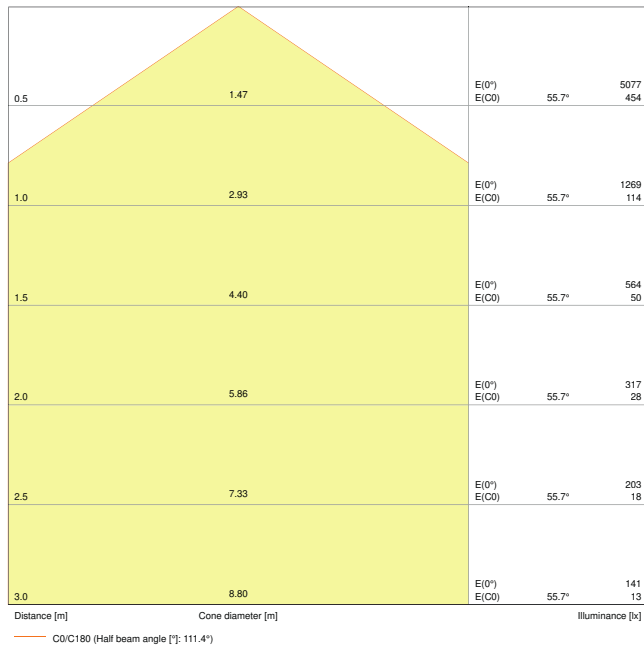

LDC typ cone

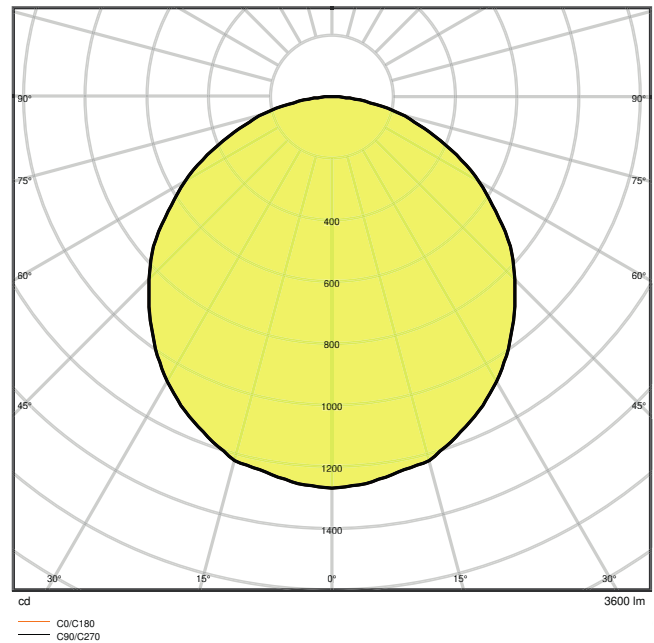

LDC typ polar

Dimensions & Weight

| | |
|----------------|-----------|
| Length | 595.00 mm |
| Width | 595.00 mm |
| Height | 35.00 mm |
| Product weight | 1800.00 g |

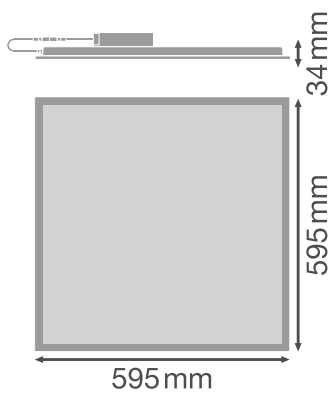

Materials & Colors

| | |
|--|------------------|
| Product color | White |
| Housing color | White |
| Body material | Steel |
| Cover material | Polystyrene (PS) |
| Light emitting surface material | Polystyrene |
| Glow Wire Test according to IEC 60695-2-12 | 650 °C |
| Mercury content | 0.0 mg |

Application & Mounting

| | |
|--|----------------------------|
| Ambient temperature range | -10...+45 °C |
| Type of connection | Screwless terminal |
| Type of protection | IP40 |
| Protection class IK (shock resistance) | IK02 |
| Dimmable | No |
| Mounting type | Recessed/Suspended/Surface |
| Mounting location | Ceiling / Wall |
| Application environment | Indoor |
| Mounting length | 580 mm |
| Mounting width | 580 mm |
| Mounting depth | 50,0 mm |
| LED module replaceable | Not replaceable |

Lifespan

| | |
|----------------------------|---------|
| Lifespan L70/B50 at 25 °C | 50000 h |
| Lifespan L80/B10 at 25 °C | 50000 h |
| Lifespan L90/B10 at 25 °C | 30000 h |
| Number of switching cycles | 25000 |

Control gear

| | |
|-----------------------------|-------|
| ECG - Output ripple current | ≤ 5 % |
|-----------------------------|-------|













Certificates & Standards

| | |
|--|---------------|
| Standards | CE / CB / EAC |
| Luminaire with limited surface temperature, "D sign" | No |
| Ball shot safe | No |

EQUIPMENT / ACCESSORIES

- Accessories for several mounting options available
- External control gear included
- Security brackets included

DOWNLOAD DATA

| DOWNLOAD DATA | |
|--|-------------------------------|
|  | User instruction |
|  | User instruction |
|  | Addon Technical Information |
|  | Addon Technical Information |
|  | Tender documents |
|  | Declarations Of Conformity CE |
|  | IES file (IES) |
|  | LDT file (Eulumdat) |
|  | R3D file (Relux 3D Model) |
|  | ROLF file (RELUX) |
|  | M3D file (3D Model) |
|  | ULD file (DIALux) |
|  | UGR file (UGR table) |

LOGISTICAL DATA

| Product code | Packaging unit (Pieces/Unit) | Dimensions (length x width x height) | Gross weight | Volume |
|---------------|------------------------------|--------------------------------------|--------------|-----------------------|
| 4058075392403 | Folding box 1 | 602 mm x 40 mm x 648 mm | 2192.00 g | 15.60 dm ³ |

| Product code | Packaging unit (Pieces/Unit) | Dimensions (length x width x height) | Gross weight | Volume |
|---------------|------------------------------|--------------------------------------|--------------|-----------------------|
| 4058075392410 | Shipping box 4 | 667 mm x 182 mm x 634 mm | 10015.00 g | 76.96 dm ³ |

The mentioned product code describes the smallest quantity unit which can be ordered. One shipping unit can contain one or more single products. When placing an order, for the quantity please enter single or multiples of a shipping unit.

ADDITIONAL CATALOG INFORMATION

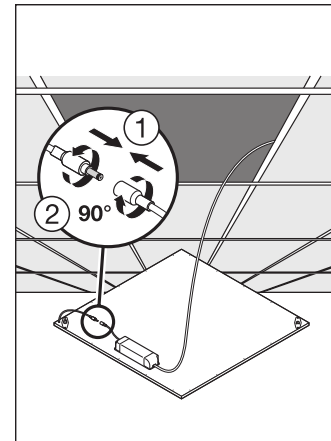
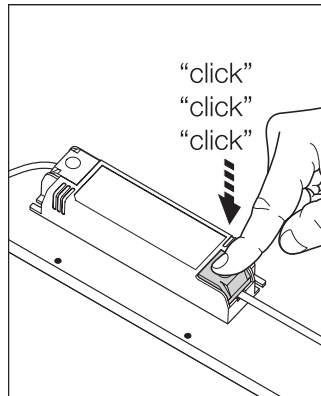
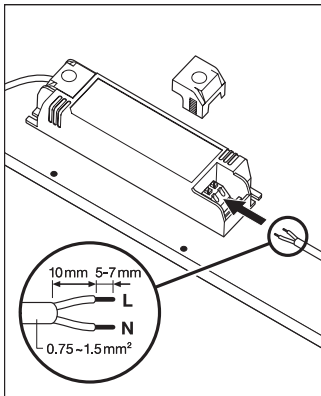

References / Links

- For Guarantee see www.ledvance.com/guarantee

DISCLAIMER

Subject to change without notice. Errors and omission excepted. Always make sure to use the most recent release.