



Control Panel Technical Guide

How to quickly design optimized
contactor assemblies





Pre-fabricated assemblies, mounting kits and electrical links make your motor starter assemblies smarter to design, mount and maintain with limited risk of errors.

Reverser

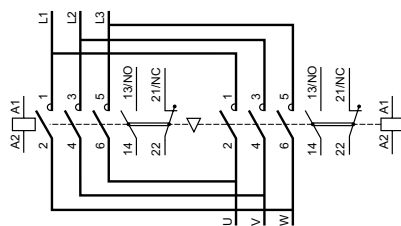

Changeover

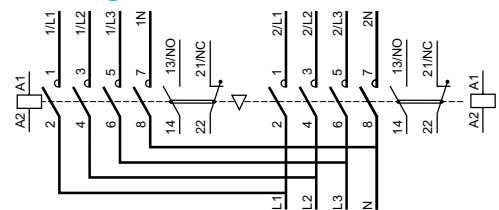

Star Delta

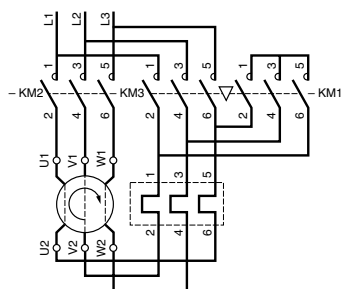

Low/High speed

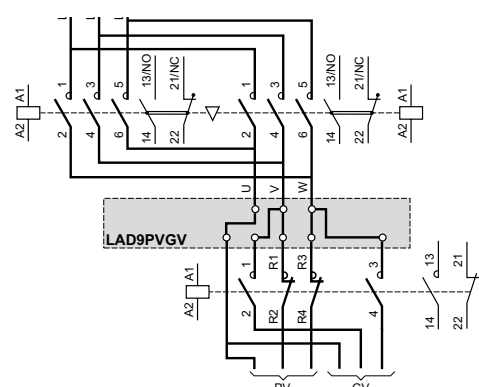

TeSys K, D, F contactor-based solutions

Challenging choice and solutions

Selecting the most appropriate components can be a challenge for designers, especially when they have to deal with strong control panel compactness constraints and assembling time optimization. This guide helps you to choose a TeSys solution, whether fully pre-cabled starters, monoblock assemblies, or contactors with assembling kits.

Fully pre cabled solutions

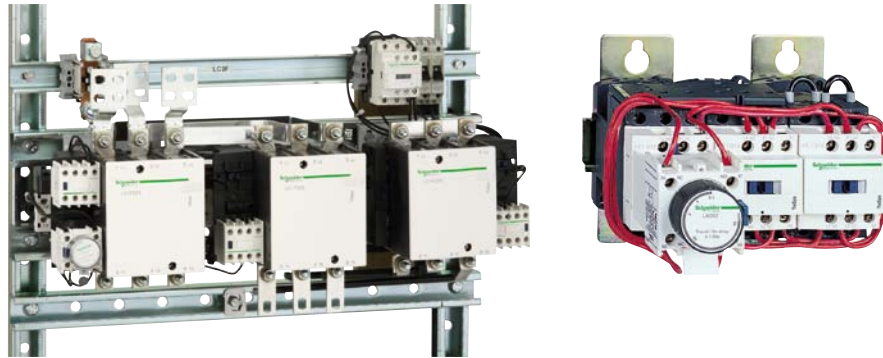

Monoblock assemblies



Components & kits

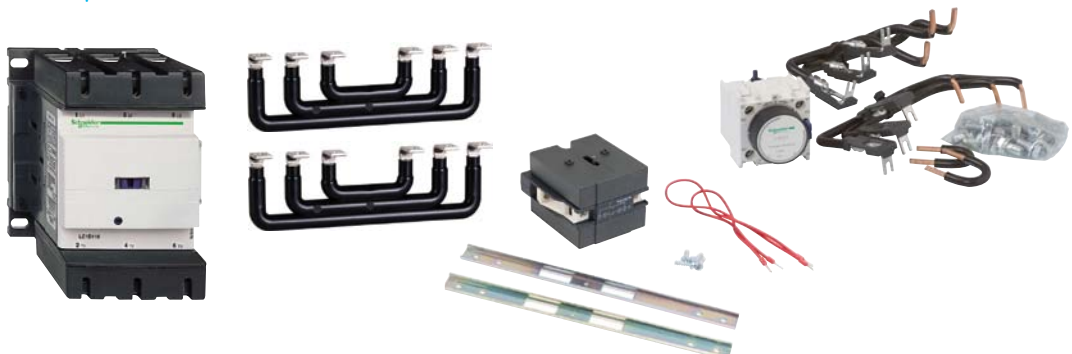

Find in this guide:

- product selection tables per application (Reverser, Speed selection, Star-Delta, Changeover)
- product technical data, commercial references, tips, for your specific designs.



TeSys K, D, F contactor-based solutions

Recommended designs are based on TeSys K, D or F contactors. The choice of the type will be done according to the project constraints: motor power, panel compactness, required connection mode.

Pre-fabricate assemblies: 2 or 3 contactors are mechanically and electrically pre-assembled in our factories, for simpler choice and time saving.

Components for custom-design: selections of coordinated contactors, accessories, kits, electrical links are recommended for several motor powers and various functions. Assembly is done by customer.

Pre-cabled assemblies

OR

Components for custom-design

TeSys K



Motors from 2.2 to 7.5 kW



TeSys D



Motors from 4 to 75 kW



TeSys F



Motors from 55 to 560 kW

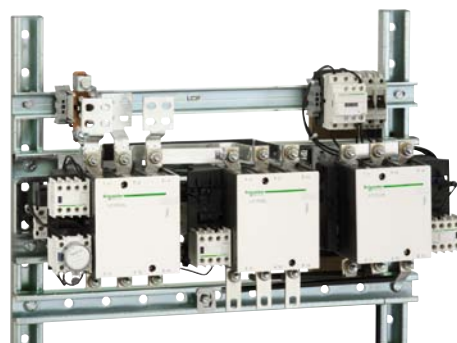

Summary

Part A: solutions per application..... p. 7

A

Motor reversers..... p. 7

1

Monoblock reversers & selected components for custom design based on TeSys K, D, F

Motor reversers + Low/High speed control..... p. 21

2

Selected components for custom design based on TeSys D

Motor Star-Delta starters..... p. 25

3

Fully prewired Star Delta starters & selected components for custom design based on TeSys K, D, F

Source and load changeover..... p. 35

4

Monoblock changeovers & selected components for custom design based on TeSys K, D, F

Part B: contactors & accessories p. 43

B

TeSys K..... p. 43

5

TeSys D..... p. 48

6

TeSys F..... p. 60

7

Products reference index..... p. 71



Part A: solutions per application



Motor reversers

A

1

2

3

4

Principle

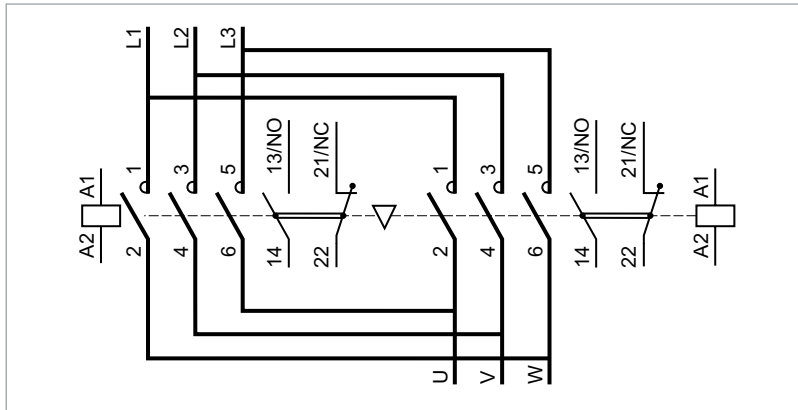

The motor reversing action is obtained by permutation of 2 power phases. The motor reverser is composed of 2 identical 3 pole contactors. Each one can withstand the full motor current. They are mechanically and electrically interlocked to prevent simultaneous closing which would cause a short circuit.

X1 open - X2 open	>	U = V = W = no voltage	>	Motor stopped
X1 closed - X2 open	>	U = L2; V = L1; W = L3	>	Rotation A
X1 open - X2 closed	>	U = L1; V = L2; W = L3	>	Rotation B
X1 closed - X2 closed	>	not possible		

Notes

Mechanical + electrical contactor interlocking should always be preferred for improved reliability. Choose contactors with NC auxiliary contacts to achieve electrical interlocking.



Conditions for safe switching from 1 direction of rotation to another are:

- intermediate period of no power on motor terminals
- motor full stop except when reverser is used for motor plug braking

In order to avoid huge mechanical constraints and overcurrents.



2.2 to 7.5 kW (400 V) - TeSys K

Reversers - screw clamp terminals, spring terminals

Pre-assembled

TeSys K blocks of 2 contactors

- DIN rail mounting
- built-in auxiliary contacts
- built-in mechanical interlock
- AC or DC coil control
- screw clamp terminals or spring terminals
- pre-assembled power links on screw-clamp type assembly only.

LC2K•••• Screw clamp terminals



LC2K0910B7

LC2K••3•• Spring terminals



LC2K0913P7

Spring-type assembly: power links to be provided and wired by customer.

AC-3 rating (A)	AC-1 rating (A)	Power poles		Auxiliary contacts		Assembly references			
		NO	NC	NO	NC	Screw clamp terminals		Spring terminals*	
AC coil control						Standard contactors	Silent contactors	Standard contactors	Silent contactors
6	-	3	-	1	-	LC2K0610••	⁽¹⁾	LC2K06103B7 or P7 ⁽²⁾	-
		3	-	-	1	LC2K0601••	⁽¹⁾	LC2K06013B7 or P7 ⁽²⁾	-
9	20 ⁽¹⁾	3	-	1	-	LC2K0910••	⁽¹⁾	LC2K09103B7 or P7 ⁽²⁾	-
		3	-	-	1	LC2K0901••	⁽¹⁾	LC2K09013B7 or P7 ⁽²⁾	-
12	20 ⁽¹⁾	3	-	1	-	LC2K1210••	⁽¹⁾	LC2K12103B7 or P7 ⁽²⁾	-
		3	-	-	1	LC2K1201••	⁽¹⁾	LC2K12013B7 or P7 ⁽²⁾	-
16	-	3	-	1	-	LC2K1610••	-	-	-
		3	-	-	1	LC2K1601••	-	-	-
DC coil control						Standard contactors	Low consumption	Standard contactors	Low consumption
6	-	3	-	1	-	LP2K0610••	LP5K0610BW3 ⁽²⁾	LP2K06103BD ⁽²⁾	LP5K06103BW3 ⁽²⁾
		3	-	-	1	LP2K0601••	LP5K0601BW3 ⁽²⁾	LP2K06013BD ⁽²⁾	LP5K06013BW3 ⁽²⁾
9	20 ⁽¹⁾	3	-	1	-	LP2K0910••	LP5K0910BW3 ⁽²⁾	LP2K09103BD ⁽²⁾	LP5K09103BW3 ⁽²⁾
		3	-	-	1	LP2K0901••	LP5K0901BW3 ⁽²⁾	LP2K09013BD ⁽²⁾	LP5K09013BW3 ⁽²⁾
12	20 ⁽¹⁾	3	-	1	-	LP2K1210••	LP5K1210BW3 ⁽²⁾	LP2K12103BD ⁽²⁾	LP5K12103BW3 ⁽²⁾
		3	-	-	1	LP2K1201••	LP5K1201BW3 ⁽²⁾	LP2K12013BD ⁽²⁾	LP5K12013BW3 ⁽²⁾

(*) AC1 rating limited to 10 A with spring terminals (max. cable: 1.5 mm²)

(1) Possible preassembled reversing contactors: please, contact your local sales representative

(2) For other voltage code, please contact your local sales representative

Coil voltage: replace 2 dots at end of commercial references by voltage code (P7 = 230 V 50-60 Hz; BD = 24 V DC; BW3 = 24 V DC low consumption; other codes, see page 44).

2.2 to 7.5 kW (400 V) - TeSys K

Reversers - Faston terminals, solder pins

Pre-assembled

TeSys K blocks of 2 contactors

- DIN rail mounting
- built-in auxiliary contacts
- built-in mechanical interlock
- AC or DC coil control
- faston or solder pin terminals.

LC2K••7••
Faston terminals



LC2K09107M7

Power links to be provided and wired by customer.

LC2K••5••
Solder pin terminals



LC2K09105B7

AC-3 rating	AC-1 rating	Power poles		Auxiliary contact		Assembly references			
(A)	(A)	NO	NC	NO	NC	Faston terminals		Solder pin terminals	
AC coil control						Standard contactors	Silent contactors	Standard contactors	Silent contactors
6	-	3	-	1	-	LC2K06107••	(1)	LC2K06105••	LC8K06105B7 (2)
		3	-	-	1	LC2K06017••	(1)	LC2K06015••	LC8K06015B7 (2)
9	20	3	-	1	-	LC2K09107••	(1)	LC2K09105••	LC8K09105B7 (2)
		3	-	-	1	LC2K09017••	(1)	LC2K09015••	LC8K09015B7 (2)
12	20	3	-	1	-	LC2K12107••	(1)	(1)	(1)
		3	-	-	1	LC2K12017••	(1)	(1)	(1)
16	-	3	-	1	-	(1)	-	(1)	-
		3	-	-	1	(1)	-	(1)	-
DC coil control						Standard contactors	Low consumption	Standard contactors	Low consumption
6	-	3	-	1	-	LP2K06107BD (2)	(1)	LP2K06105BD (2)	LP5K06105BW3 (2)
		3	-	-	1	LP2K06017BD (2)	(1)	LP2K06015BD (2)	LP5K06015BW3 (2)
9	20	3	-	1	-	LP2K09107BD (2)	(1)	LP2K09105BD (2)	LP5K09105BW3 (2)
		3	-	-	1	LP2K09017BD (2)	(1)	LP2K09015BD (2)	LP5K09015BW3 (2)
12	20	3	-	1	-	(1)	(1)	(1)	(1)
		3	-	-	1	(1)	(1)	(1)	(1)

(1) Possible preassembled reversing contactors: please, contact your local sales representative

(2) For other voltage code, please contact your local sales representative

Coil voltage: replace 2 dots at end of commercial references by voltage code (P7 = 230 V 50-60 Hz; BD = 24 V DC; BW3 = 24 V DC low consumption; other codes, see page 44).

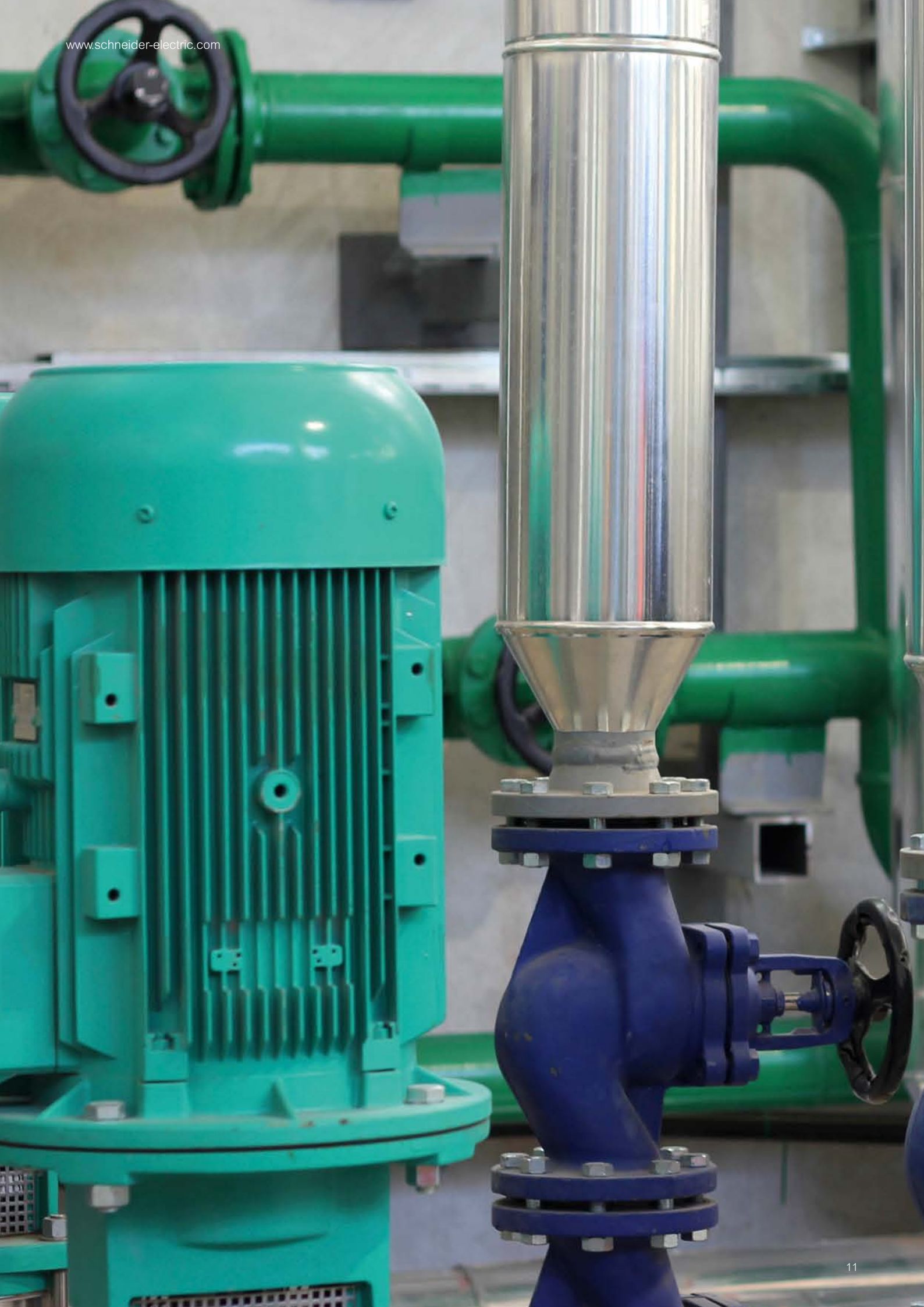

4 to 75 kW (400 V) - TeSys D

Reversers - screw clamp terminals

Pre-assembled

TeSys D contactor blocks with interlocking device, built-in auxiliary contacts.

Blocks of 2 TeSys D contactors

- DIN rail or plate mounting
- built-in auxiliary contacts
- built-in mechanical interlock
- interference filter
- prewired power links
- AC or DC coil control (depending on models)
- screw clamp terminals.

LC2D screw-clamp terminals

LC2D••A EverLink® BTR screw clamp terminals



AC-3 rating (A)	Product references
9	LC2D09•• ⁽¹⁾
12	LC2D12•• ⁽¹⁾
18	LC2D18•• ⁽¹⁾
25	LC2D25•• ⁽¹⁾
32	LC2D32•• ⁽¹⁾
38	LC2D38•• ⁽¹⁾
40	LC2D40A•• ^{(2) (4)}
50	LC2D50A•• ^{(2) (4)}
65	LC2D65A•• ^{(2) (4)}
80	LC2D80•• ⁽²⁾
95	LC2D95•• ⁽²⁾
115	LC2D115•• ⁽³⁾
150	LC2D150•• ⁽³⁾

As a complementary, electrical interlock can be achieved with the built in auxiliary contacts.

(1) Mechanical interlock only; add V for electro-mechanical interlock (eg.: LC2D09P7V)

(2) With mechanical interlock only

(3) With electromechanical interlock

(4) Power connection by EverLink® BTR screw clamp terminals and control by screw clamp terminals
Power links to be added by customer (see components next page).

Coil voltage: replace 2 dots at end of commercial references by voltage code (P7 = 230 V 50-60 Hz; BD = 24 V DC; BW3 = 24 V DC low consumption; other codes, see page 48).

Alternative solution

Enclosed Direct-On-Line Reversing starters

- without isolating device 6...65 A : ref. LE2K••••, LE2D••••
- with isolating device (fuses) 6...35 A : ref. LE8K••••, LE8D••••

Please refer to TeSys catalogue ref. MKTED210011 – chapter A1.



LE2D09P7

4 to 75 kW (400 V) - TeSys D

Reversers - screw clamp terminals

Kits for customer assembly

Power links, electrical interlockings, mechanical interlockings for TeSys D contactors.

Kits for 9 to 38 A



LAD9R1
Assembling kit comprising:

- LAD9V5 parallel link
- LAD9V6 inverting link
- LAD9V2 mechanical interlock
- Assembling staple



LAD9R1V
Assembling kit comprising:

- LAD9V5 parallel link
- LAD9V6 inverting link
- LAD9V2 mechanical interlock
- LAD9V1 electrical interlock
- Assembling staple

Kit for 40 to 65 A



LAD9R3
Assembling kit comprising:

- LA9D65A6 parallel link
- LA9D65A9 inverter link
- LAD4CM mechanical interlock

Components for 80, 95 A



LA9D8069
Parallel + inverting links for 80, 95 A



LA9D4002
AC electro-mechanical interlocking for 80 A



LA9D8002
DC electro-mechanical interlocking for 80 A



LA9D50978
AC mechanical interlocking for 95 A



LA9D80978
DC mechanical interlocking for 95 A

Components for 115, 150 A



LA9D11569
Parallel + inverting links for 115, 150 A

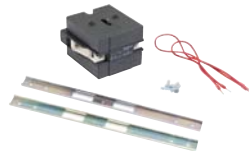

LA9D11502
Set of electro-mechanical interlocking components for 115, 150 A

Characteristics	Bill of material (contactors to be completed with...)			
AC-3 rating (A)	Contactors	Set of electrical power links	Mechanical interlocking	Electrical interlocking
9	2x LC1D09**	Kits: LAD9R1 : power links + mechanical interlock or LAD9R1V : power link + mechanical interlock + electrical interlock (white power links)		
12	2x LC1D12**			
18	2x LC1D18**			
25	2x LC1D25**			
32	2x LC1D32**			
38	2x LC1D38**			
40	2x LC1D40A**(1)	Kit: LAD9R3 : power links + mechanical interlock		Customer cabling
50	2x LC1D50A**(1)			
65	2x LC1D65A**(1)			
80	2x LC1D80**	Power links: LA9D8069	Mechanical + electrical interlocks: LA9D4002 for AC - LA9D8002 for DC	
95	2x LC1D95**		Mechanical interlocks: LA9D50978 for AC / LA9D80978 for DC	
115	2x LC1D115**	Power links: LA9D11569	Mechanical + electrical interlocks: LA9D11502	
150	2x LC1D150**			

(1) Power connection by EverLink® BTR screw connectors and control by screw clamp terminals

Coil voltage: replace 2 dots at end of commercial references by voltage code (P7 = 230 V 50-60 Hz; BD = 24 V DC; BW3 = 24 V DC low consumption; other codes, see page 48).

4 to 75 kW (400 V) - TeSys D

Reversers - screw terminals for lugs or bars

Pre-assembled

Blocks of 2 TeSys D contactors

- DIN rail or plate mounting
- built-in auxiliary contacts
- mechanical and/or electrical interlock
- interference filter
- AC or DC coil control
- screw terminals for lugs or bars.

Power links to be added by customer (see components next page).

LC2D**5** screw terminals for lugs or bars



LC2D326**



LC2D1156**

AC-3 rating (A)	Product references
9	LC2D096** ⁽¹⁾
12	LC2D126** ⁽¹⁾
18	LC2D186** ⁽¹⁾
25	LC2D256** ⁽¹⁾
32	LC2D326** ⁽¹⁾
38	LC2D386** ⁽¹⁾
40	-
50	-
65	-
80	-
95	-
115	LC2D1156** ⁽²⁾
150	LC2D1506** ⁽²⁾

(1) Mechanical interlock only

(2) Electromechanical interlock

Coil voltage: replace 2 dots at end of commercial references by voltage code (P7 = 230 V 50-60 Hz; BD = 24 V DC; BW3 = 24 V DC low consumption; other codes, see page 48).

4 to 75 kW (400 V) - TeSys D

Reversers - screw terminals for lugs or bars

Components for customer assembly

Power links, electrical interlockings, mechanical interlocks for TeSys D contactors.

Sets of power links for LC1D096•• D386 contactors



LAD9V10
Upstream parallel power link

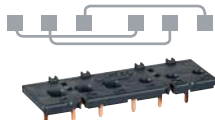

LAD9V5



LAD9V11
Downstream inverting power link

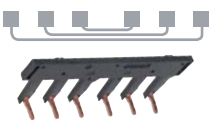

LAD9V6

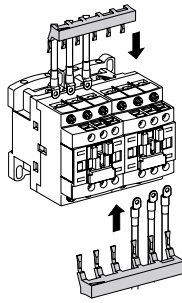

LAD9VP4
= LAD9V10 + LAD9V11

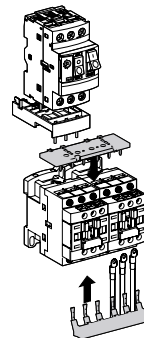

LAD9VP1
= LAD9V5 + LAD9V11

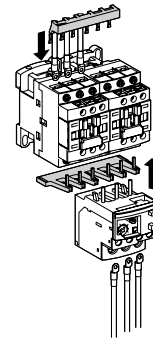

LAD9VP2
= LAD9V10 + LAD9V6

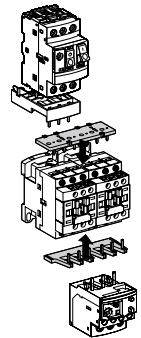

LAD9VP3
= LAD9V5 + LAD9V6



LAD9V2
Mechanical interlock with assembling staples



LAD4CM
Mechanical interlock



LA9D4002
AC - electro-mechanical interlocking for 80 - 95 A



LA9D8002
DC - electro-mechanical interlocking for 80 - 95 A

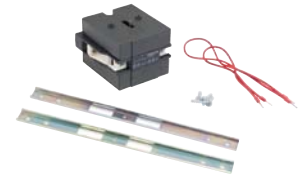

LA9D11502
Set of electro-mechanical interlocking components

Characteristics	Bill of material (contactors to be completed with...)			
	Contactors	Set of power links	Mechanical interlocking	Electrical interlocking
AC-3 rating (A)	2x LC1D096••	Depending on customer configuration (see diagrams above): LAD9VP1 / LAD9VP2 / LAD9VP3 / LAD9VP4	LAD9V2	Customer cabling
9	2x LC1D126••			
12	2x LC1D186••			
18	2x LC1D256••			
25	2x LC1D326••			
32	2x LC1D386••	Customer cabling	LA9D4002 for AC - LAD8002 for DC	
38	2x LC1D40A6••			
40	2x LC1D50A6••			
50	2x LC1D65A6••			
65	2x LC1D806••			
80	2x LC1D956••	LA9D11502		
95	2x LC1D1156••			
115	2x LC1D1506••			
150	2x LC1D1506••			

4 to 75 kW (400 V) - TeSys D

Reversers - spring terminals

Pre-assembled

Blocks of 2 TeSys D contactors

- DIN rail mounting
- built-in auxiliary contacts
- mechanical interlock
- interference filter
- AC or DC coil control
- spring terminals.

Power links to be added by customer (see components next page).

LC2D••3•• screw terminals for lugs or bars



LC2D093••

AC-3 rating (A)	Product references
9	LC2D093•• ⁽¹⁾
12	LC2D123•• ⁽¹⁾
18	LC2D183•• ⁽¹⁾
25	LC2D253•• ⁽¹⁾
32	LC2D323•• ⁽¹⁾
40	LC2D40A3•• ⁽²⁾
50	LC2D50A3•• ⁽²⁾
65	LC2D65A3•• ⁽²⁾

(1) Power and control by spring terminals

(2) Power by EverLink[®] terminals, control by spring terminals

Coil voltage: replace 2 dots at end of commercial references by voltage code (P7 = 230 V 50-60 Hz; BD = 24 V DC; BW3 = 24 V DC low consumption; other codes, see page 48).

4 to 75 kW (400 V) - TeSys D

Reversers - spring terminals

Components for customer assembly

Power links, electrical interlockings, mechanical interlocks for TeSys D contactors.

Power bus bars for LC1D**3** contactors with spring terminals

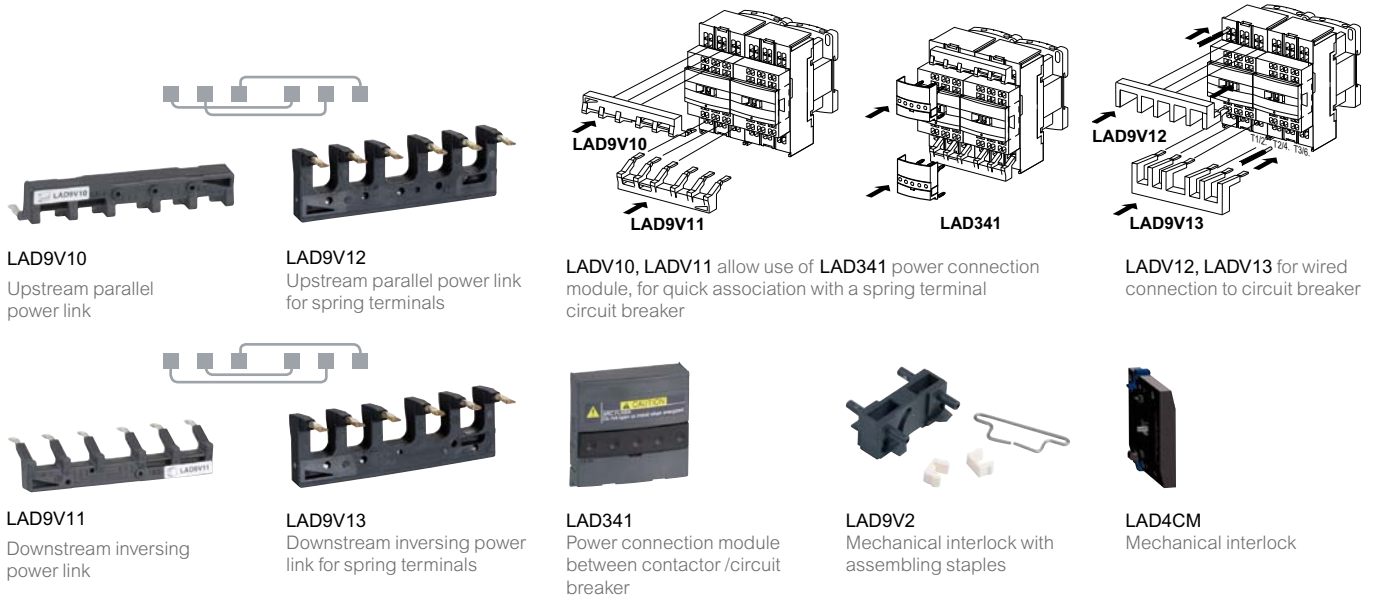

LAD9V10

Upstream parallel power link

LAD9V12

Upstream parallel power link for spring terminals

LAD9V10

LAD9V11

LADV10, LADV11 allow use of LAD341 power connection module, for quick association with a spring terminal circuit breaker

LAD341

LAD9V12

LAD9V13

LADV12, LADV13 for wired connection to circuit breaker

LAD9V11

Downstream inverting power link

LAD9V13

Downstream inverting power link for spring terminals

LAD341

Power connection module between contactor /circuit breaker

LAD9V2

Mechanical interlock with assembling staples

LAD4CM

Mechanical interlock

Characteristics	Bill of material (contactors to be completed with...)			
AC-3 rating (A)	Contactors	Set of power connections	Mechanical interlocking	Electrical interlocking
9	2x LC1D093** ⁽³⁾	Upstream: LAD9V10 or LAD9V12 ⁽¹⁾ Downstream: LAD9V11 or LAD9V13 ⁽²⁾	LAD9V2	Customer cabling
12	2x LC1D123** ⁽³⁾			
18	2x LC1D183** ⁽³⁾			
25	2x LC1D253** ⁽³⁾			
32	2x LC1D323** ⁽³⁾	Customer cabling	LAD4CM	Customer cabling
40	2x LC1D40A3** ⁽⁴⁾			
50	2x LC1D50A3** ⁽⁴⁾			
65	2x LC1D65A3** ⁽⁴⁾			

(1) LAD9V10 + LAD9V11 configuration can be used in every case

(2) LAD9V12 + LAD9V13 configuration cannot be used with a LAD341 which ensures a quick link between contactor / GV2 circuit breaker

(3) Power and control by spring terminals

(4) Power by EverLink terminals, control by spring terminals.

4 to 75 kW (400 V) - TeSys D

Reversers - Faston terminals

Pre-assembled

Blocks of 2 TeSys D contactors

- DIN rail mounting
- built-in auxiliary contacts
- mechanical interlock
- interference filter
- AC or DC coil control
- faston terminals.

Power links to be added by customer.

LC2D**9**



LC2D099**

AC-3 rating (A)	Product references
9	LC2D099**
12	LC2D129**

Coil voltage: replace 2 dots at end of commercial references by voltage code (P7 = 230 V 50-60 Hz; BD = 24 V DC; BW3 = 24 V DC low consumption; other codes, see page 48).

Components for customer assembly

TeSys D contactors, mechanical interlockings.



LAD9V2
Mechanical interlock with assembling staples

Characteristics	Bill of material (contactors to be completed with...)			
AC-3 rating (A)	Contactors	Mechanical interlocking	Electrical interlocking	Set of power connections
9	2x LC1D099**	LAD9V2	Customer cabling	Customer cabling
12	2x LC1D129**			

Coil voltage: replace 2 dots at end of commercial references by voltage code (P7 = 230 V 50-60 Hz; BD = 24 V DC; BW3 = 24 V DC low consumption; other codes, see page 48).

4 to 75 kW (400 V) - TeSys F

Reversers - screw type terminals for lugs or bars

Pre-assembled

Blocks of 2 TeSys F contactors:

- with mounting accessories
- mechanical interlock
- prewired power links.

2 contactor coils, 2 contact blocks (LADN.1) for electrical interlocking, to be ordered separately by customer (refer to TeSys catalogue ref. MKTED210011 – chapter B9).

LC2F...



LC2F115

AC-3 rating (A)	Product references
115	LC2F115
150	LC2F150
185	LC2F185
225	LC2F225
265	LC2F265

Components for customer horizontal assemblies

TeSys F contactors, power links, mechanical interlocks.

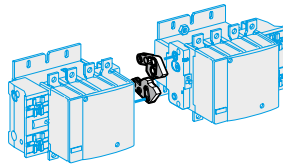

Horizontal assembly: 3-pole contactors with mechanical interlock



LA9FJ970
Mechanical interlocks



LA9FJ976
6 power links

Characteristics	Bill of material (contactors to be completed with...)		
	Contactors	Set of power connections	Mechanical interlocking
AC-3 rating (A)			
115	2x LC1F115	LA9FF976	LA9FF970
150	2x LC1F150	LA9F15076	LA9FF970
185	2x LC1F185	LA9FG976	LA9FG970
225	2x LC1F225	LA9F22576	LA9FG970
265	2x LC1F265	LA9FH976	LA9FJ970
330	2x LC1F330	LA9FJ976	LA9FJ970
400	2x LC1F400	LA9FJ976	LA9FJ970
500	2x LC1F500	LA9FK976	LA9FJ970
630	2x LC1F630	LA9FL976	LA9FL970
800	2x LC1F800	LA9FL976	LA9FL970

To be ordered as a necessary complement (refer to TeSys catalogue ref. MKTED210011 – chapter B9):
2 contactor coils (AC or DC) - 2 LADN.1 contact blocks for electrical interlocking.

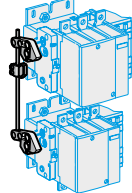

Vertical contactor assembly is also possible. See page 69.

All power connections are to be made by customer.







Motor reversers + Low/High speed control

Principle

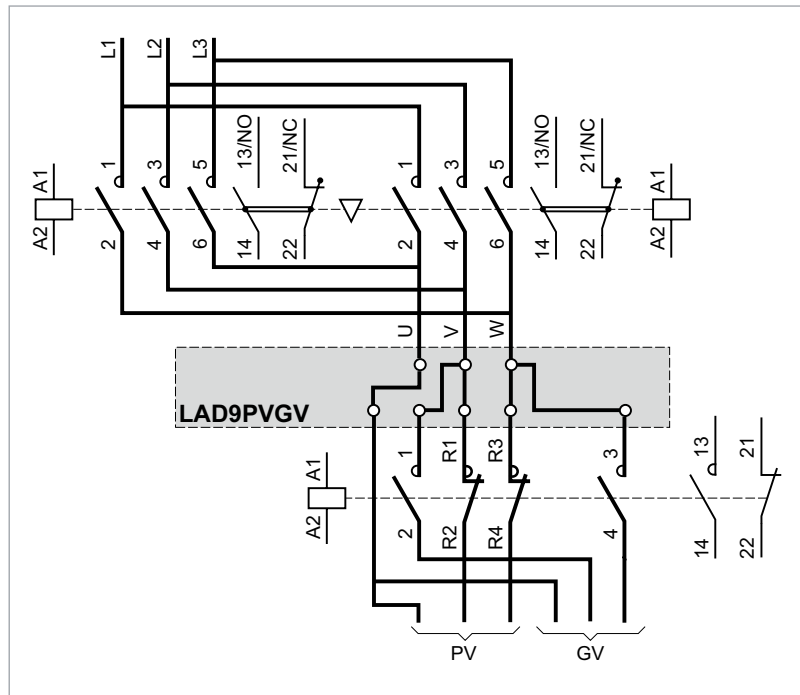

The motor reversing action is obtained by permutation of 2 power phases. This function is provided by KM1, KM2.
 The 2-speed motor has 2 sets coils: U1-V1-W1 and U2-V2-W2.
 Each one is dedicated to a speed.

1 phase is permanently connected to both W1 and W2.

KM3 is dedicated to Low/High speed control:
 2 NO + 2 NC contacts are used to switch the remaining phases to U1/V1 and U2/V2.

Note

Mechanical + electrical contactor interlocking should always be preferred for improved reliability.



4 to 11 kW (400 V) - TeSys D

Reverser/controller - screw clamp terminals

Kit for customer assembly

A dedicated kit + 3 contactors allow customer to build a complete motor reversing, Low / High speed assembly.

Kit LAD9PVGV

Included:

- power links + electrical / mechanical interlock, full content of LAD9R1V reversing kit
- KM2 / KM3 interconnection block.

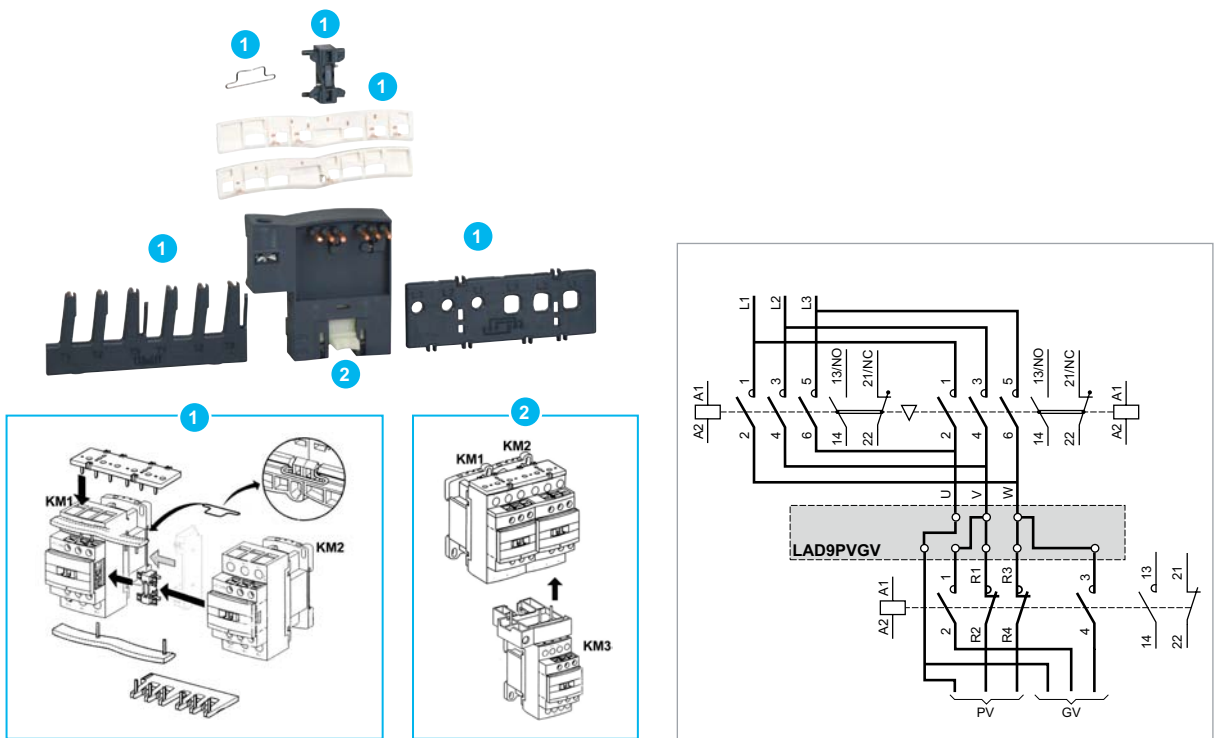

Type	Bill of material		
	KM1 - KM2 contactors	KM3 contactor	Reversing, Low/High speed assembling kit
AC-3 rating (A)	3P reversing contactors	4P contactors (2NO, 2NC)	
9	2x LC1D09**	LC1D098**	LAD9PVGV
12	2x LC1D12**	LC1D128**	
18	2x LC1D18**	LC1D188**	
25	2x LC1D25**	LC1D258**	

Coil voltage: replace 2 dots at end of commercial references by voltage code (P7 = 230 V 50-60 Hz; BD = 24 V DC; BW3 = 24 V DC low consumption other codes, see page 48).

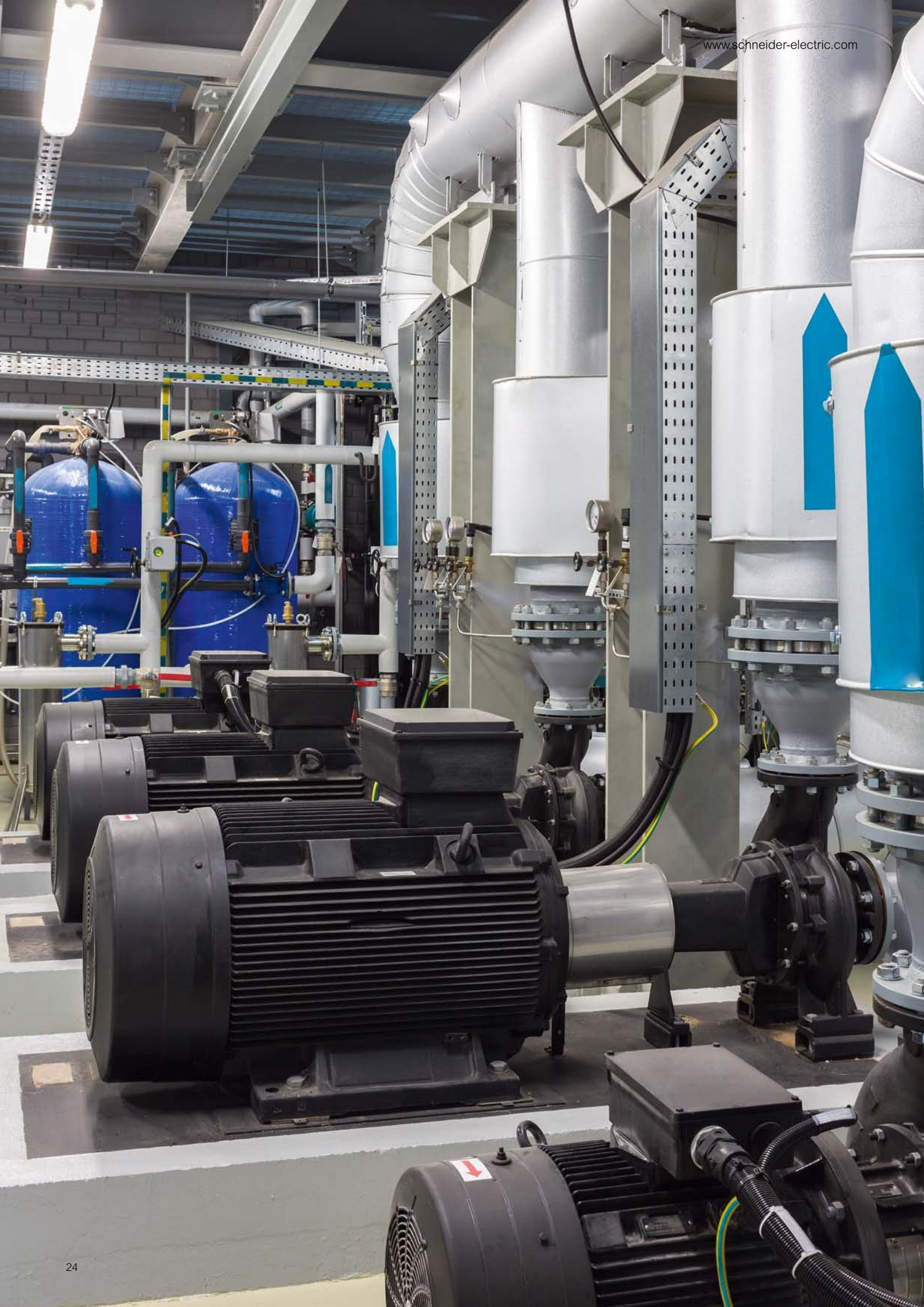



Motor Star-Delta starters

Principle

The motor Star-Delta starters are used with high torque asynchronous motors for reducing starting inrush current. The motor is started with Star-coupled windings for a few seconds. The windings are under reduced voltage. After a delay, the coupling is switched to Delta to get a torque with reasonable current. Each winding then is under full voltage.

One line contactor (KM2) is used for main power switching, two are used for coupling windings from Star (KM1) to Delta (KM3). Line and Delta contactors are usually of the same rating. A time delay contact block provides the KM1/KM3 control. A separate thermal overload relay can be wired.

A reverser (pair of contactors) can be wired upstream with the appropriate interlocking circuit.

Star delta, with separate thermal relay

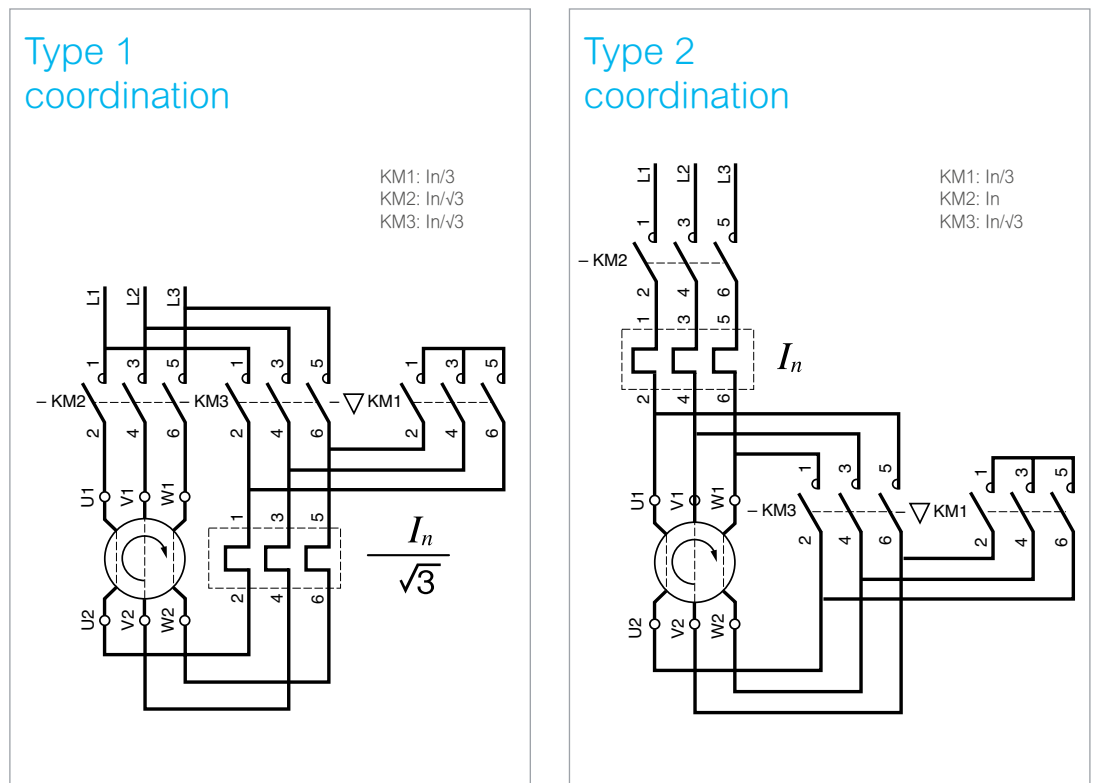

Note

Mechanical + electrical contactor interlocking should always be preferred for improved reliability.



Principle

Star delta, with thermal magnetic circuit breaker

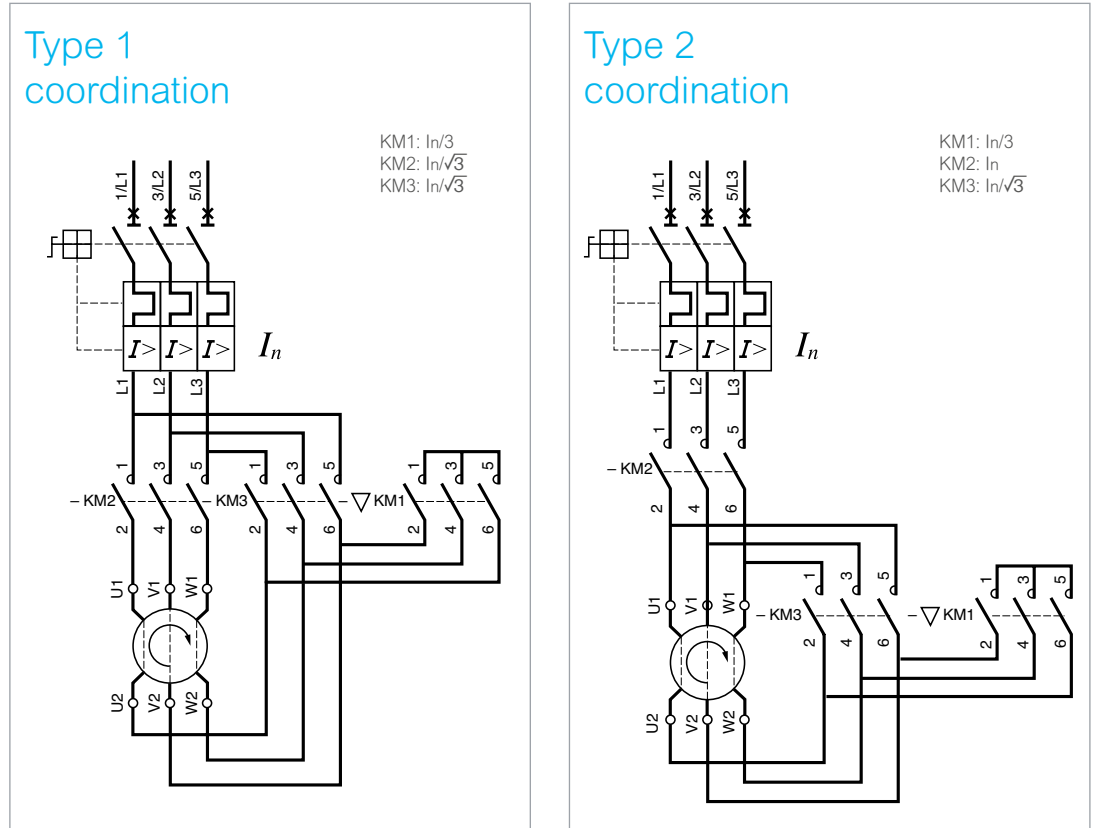

Star delta + reversing, with separate thermal relay

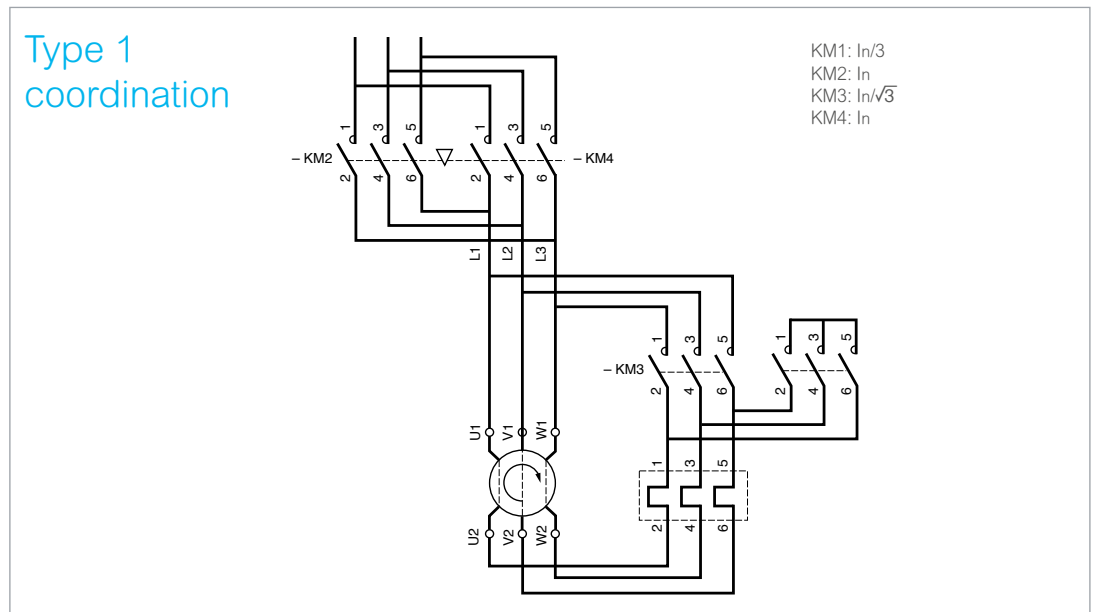

A

3

5.5 to 7.5 kW - TeSys K

Star-Delta starters - on DIN rail

Pre-assembled, pre-wired

TeSys K blocks of contactors on DIN rail (star and delta contactors cannot be separated)

- built-in mechanical interlock
- timer (30" max. starting time)
- built-in auxiliary contacts
- AC coil control
- screw clamp terminals.

LC3K**



3P 400 V motor rating (kW)	Contactor types			Assembly references
	Line	Delta	Star	
5.5	LC1K06**	LC1K06**	LC1K06**	LC3K06**
7.5	LC1K09**	LC1K09**	LC1K09**	LC3K09**

Coil voltage: replace 2 dots at end of commercial references by voltage code (P7 = 230 V 50-60 Hz; BD = 24 V DC; BW3 = 24 V DC low consumption; other codes, see page 44).

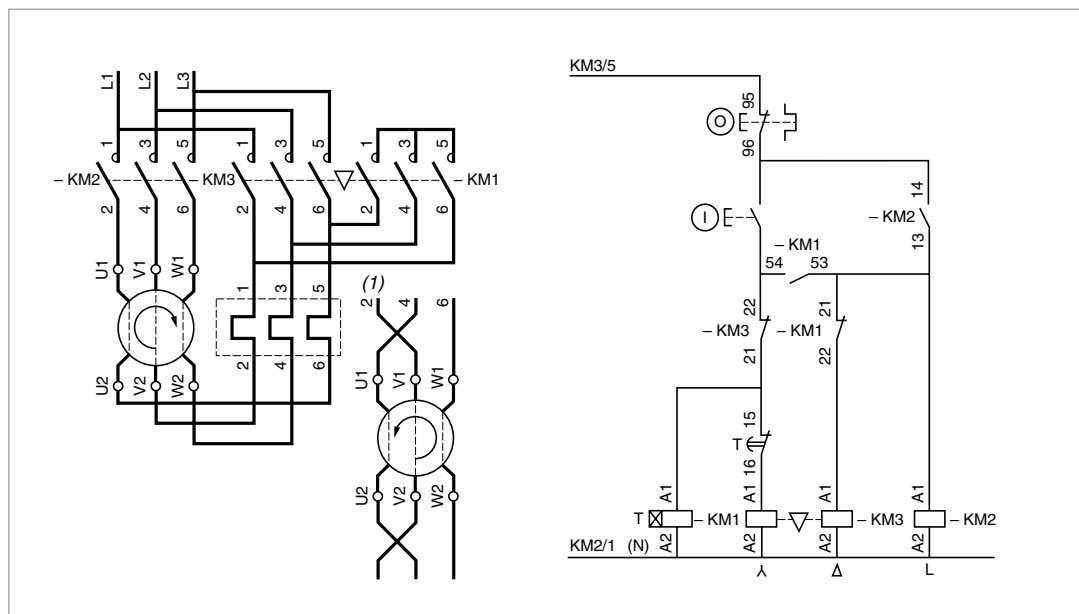

4 to 75 kW (400 V) - TeSys D

Star-Delta starters - on DIN rail

Pre-assembled, pre-wired

TeSys D blocks of contactors on DIN rail or plate

- with ou without mechanical interlock (depending on model)
- timer (30" max. starting time)
- built-in auxiliary contacts
- AC coil control
- screw clamp terminals.

LC3D**



3P 400 V motor rating (kW)	Contactor types			Mechanical interlock included	Assembly references	
	Line	Delta	Star		Plate mounted	Rail mounted
7.5	LC1D09	LC1D09	LC1D09	Yes	LC3D09A**	LC3D090A**
11	LC1D12	LC1D12	LC1D09	Yes	LC3D12A**	LC3D120A**
18.5	LC1D18	LC1D18	LC1D09	Yes	LC3D18A**	LC3D180A**
25	LC1D32	LC1D32	LC1D32	Yes	LC3D32A**	LC3D320A**
75	LC1D80	LC1D80	LC1D50	No	LC3D80**	-
			LC1D80	Yes	LC3D80**A64	-
110	LC1D115	LC1D115	LC1D80	No	LC3D115**	-
			LC1D115	Yes	LC3D115**A64	-
132	LC1D150	LC1D150	LC1D115	No	LC3D150**	-
			LC1D150	Yes	LC3D150**A64	-

Coil voltage: replace 2 dots at end of commercial references by voltage code (P7 = 230 V 50-60 Hz; BD = 24 V DC; BW3 = 24 V DC low consumption; other codes, see page 48).

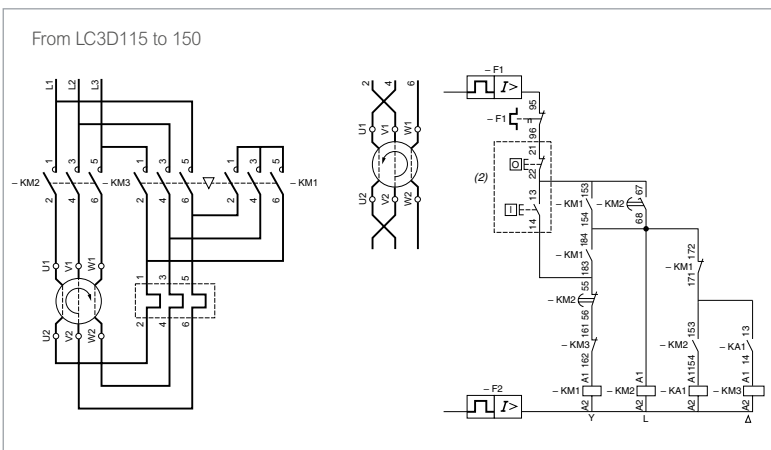
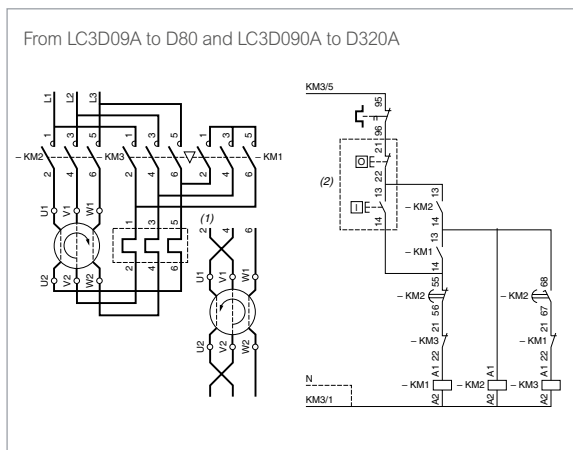

4 to 75 kW (400 V) - TeSys D

Star-Delta starters

Kits for customer assemblies

TeSys D contactors, kits with power links, electrical interlockings, mechanical interlockings, time delays.



LAD91218*



LAD91217



LAD93218



LAD93217*



LAD912GV



LAD9SD3



LA9D8017



LA9D8018



LA9D11517



LA9D15017

* Video tutorial: please scan QR code

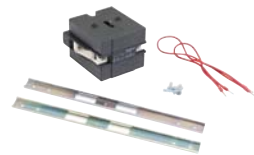

LA9D11502

3P 400 V motor rating (kW)	Bill of material							
	Contactors			Kits (with or without interlocking devices) Separate interlocking devices				
	Line	Delta	Star	Electrical power links Parallel / Reverse / Star	Interlocking devices Mechanical Electrical			
7.5	LC1D09	LC1D09	LC1D09	LAD91218 / LAD91217 / LAD912GV ⁽¹⁾⁽²⁾				
11	LC1D12 LC1D18	LC1D12 LC1D18	LC1D09 LC1D12	LAD91218 / LAD91217 / LAD912GV ⁽¹⁾⁽²⁾				
18.5	LC1D18	LC1D12 LC1D18	LC1D09	LAD91218 / LAD91217 / LAD912GV ⁽¹⁾⁽²⁾				
			LC1D12					
			LC1D18					
	LC1D25	LC1D25	LC1D09 LC1D12 LC1D18 LC1D25	LAD93218 / LAD93217 ⁽³⁾				
25	LC1D32	LC1D32	LC1D18	LAD93218 / LAD93217 ⁽³⁾				
			LC1D25				LAD91218 / LAD91217 ⁽¹⁾	
			LC1D32					
	LC1D38	LC1D38	LC1D38	LAD91218 / LAD91217				
	LC1D40A	LC1D40A	LC1D40A	LAD9SD3		Customer cabling		
LC1D50A	LC1D50A	LC1D40A LC1D50A						
LC1D65A	LC1D65A	LC1D40A LC1D50A LC1D65A						
75	LC1D80	LC1D80	LC1D50 LC1D65	LA9D8017	-	Customer cabling		
			LC1D80	LA9D8018		Customer cabling		
	LC1D95	LC1D95	LC1D80 LC1D95	LA9D8018		Customer cabling		
110	LC1D115	LC1D115	LC1D80	LA9D11517	-	Customer cabling		
			LC1D95					
			LC1D115	LA9D15017	LA9D11502			
132	LC1D150	LC1D150	LC1D115	LA9D15017	LA9D11502			
			LC1D150					

(1) LAD91218 if time delay not needed, LAD91217 if time delay needed (both kits to compose a block of 3 contactors)

(2) LAD912GV if time delay needed (this kit to compose a block of 1 GV2 circuit breaker + 3 contactors)

(3) LAD93218 if time delay not needed, LAD93217 if time delay needed.(both kits to compose a block of 3 contactors)

4 to 75 kW (400 V) - TeSys D

Star-Delta starters

Kits composition

Kit composition >	Mechanical interlocking	Electrical interlocking	Raising adaptor, to align contactor front face	Power links			Time delay auxiliary contact block	Hardware to fix contactor on mounting plate	To be ordered separately
				Short circuit	Parallel connection	Reverser connection			
LAD91217 >	LAD9V2	LAD9V1	-	LAD9P3	LAD9V5	LAD9V6	LADS2	2 x LAD9V17	LA9D12974
LAD91218 >	LAD9V2	LAD9V1	-	LAD9P3	LAD9V5	LAD9V6	-	2 x LAD9V17	LA9D12974
LAD93217 >	LAD9V2	LAD9V1	LAD9V16	LAD9P3	LAD9V5	Yes	LADS2	2 x LAD9V17	LA9D32974
LAD93218 >	LAD9V2	LAD9V1	LAD9V16	LAD9P3	LAD9V5	Yes	-	2 x LAD9V17	LA9D32974
LAD9SD3 >	LAD4CM	-	-	LAD9SD3S	LA9D65A6	LA9D65A9	LADS2	-	-
LA9D5017 >	-	-	-	Yes	Yes	Yes	LADS2	Yes	LA9D40973
LA9D5018 >	LA9D50978	-	-	Yes	Yes	Yes	LADS2	Yes	LA9D40973
LA9D8017 >	-	-	-	Yes	Yes	Yes	LADS2	Yes	LA9D80973
LA9D8018 >	Yes	-	-	LA9D8069	-	Yes	LADS2	Yes	-
LA9D11517 >	Set of power links								-
LA9D15017 >	Set of power links								LA9D11502

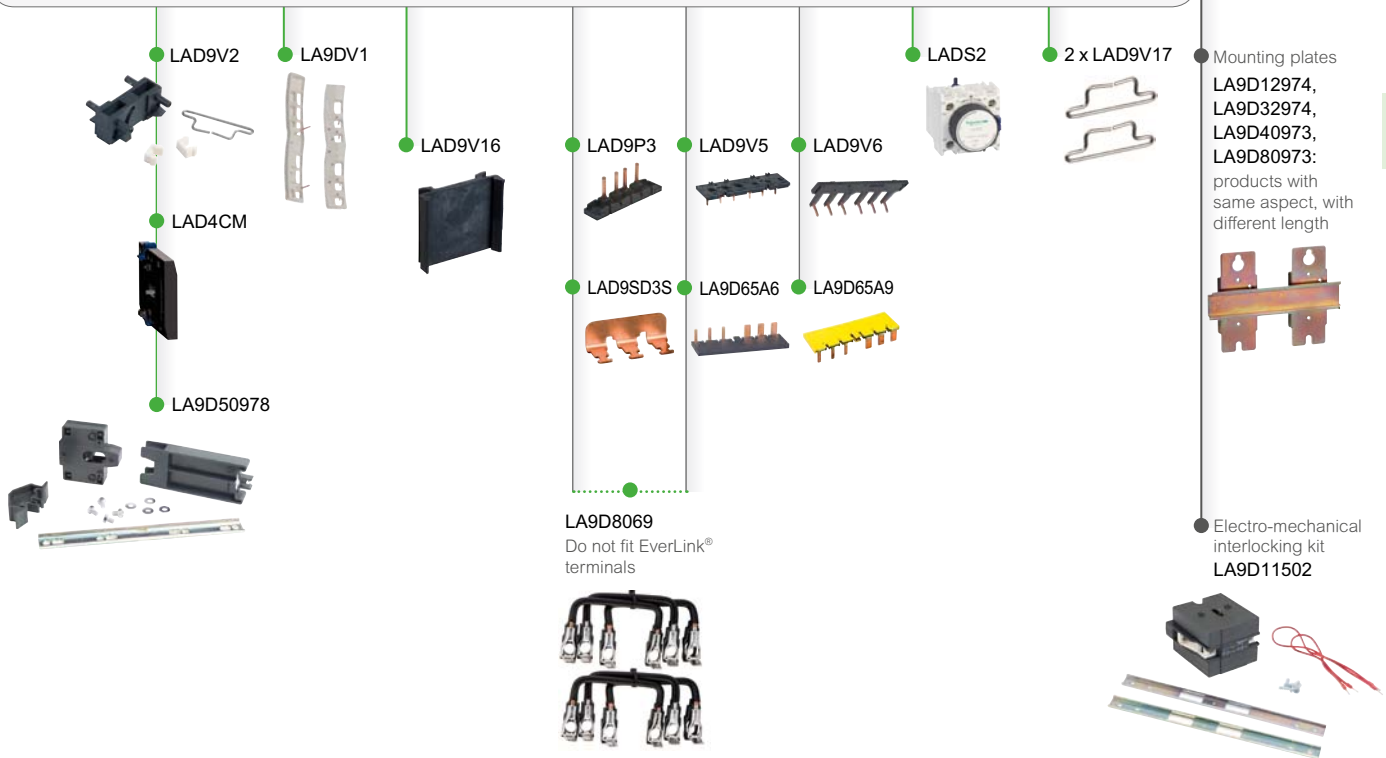

A

3

85 to 315 kW (400 V) - TeSys F

Star-Delta starters - on chassis for lugs or bars

Pre-assembled, pre-wired

TeSys F contactors on DIN rail chassis

- with (A64 version) or without mechanical interlock
- timer (20 or 30" (A64 version) max. starting time)
- AC coil control
- screw type terminals for bars, lugs, cables.

LC3F115... 225

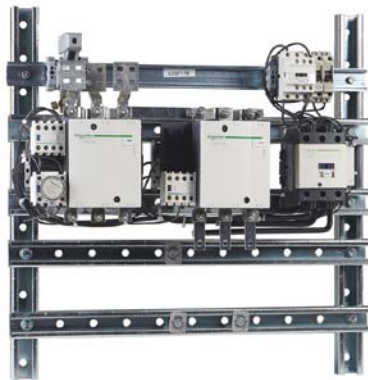

LC3F265... 400



WARNING:
Remember that electrical AND mechanical interlocking should always be preferred to ensure assembly reliability.



WARNING:
When no mechanical interlock is available, beware to add an electrical interlock with sufficient time delay to avoid short-circuit.

Motor Star-Delta starters pre-assembled on chassis

3P 400 V motor rating (kW)	Contactor types			Mechanical interlock included	Assembly references
	Line	Delta	Star		
85	LC1F115	LC1F115	LC1F80	No	LC3F115**
135	LC1F150	LC1F150	LC1F115	No	LC3F150**
160	LC1F185	LC1F185	LC1F150	No	LC3F185**
			LC1F185	Yes	LC3F185**A64
200	LC1F225	LC1F225	LC1F185	No	LC3F225**
			LC1F225	Yes	LC3F225**A64
220	LC1F265	LC1F265	LC1F185	No	LC3F265**
			LC1F265	Yes	LC3F265**A64
280	LC1F330	LC1F330	LC1F265	No	LC3F330**
			LC1F330	Yes	LC3F330**A64
315	LC1F400	LC1F400	LC1F265	No	LC3F400**
			LC1F400	Yes	LC3F400**A64

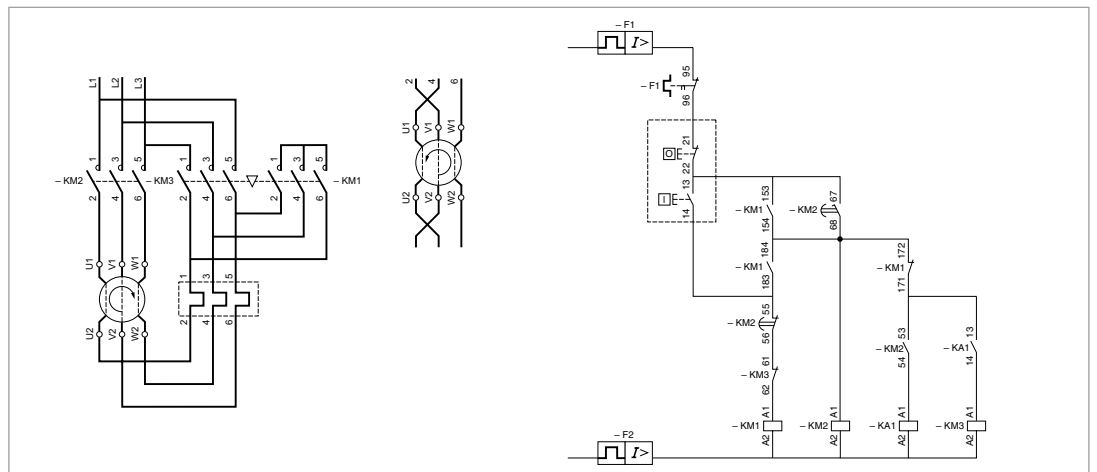

85 to 315 kW (400 V) - TeSys F

Star-Delta starters - screw terminals for lugs or bars

Components for customer assemblies

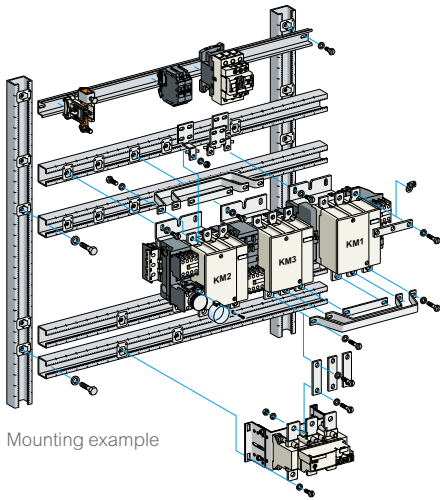

Mounting example

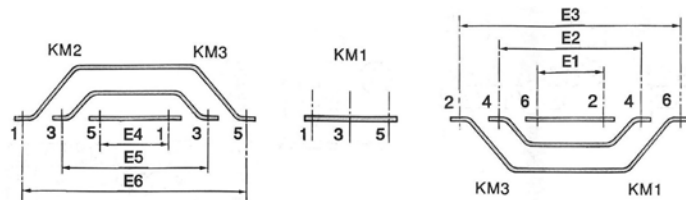

Power links dimensions for 3 identical contactors

3 x LC1-		E1 (mm)	E2 (mm)	E3 (mm)	E4 (mm)	E5 (mm)	E6 (mm)
F115	LA9-FF600	77	151	225	112	186	260
F150	LA9-F15000	71	151	231	102	182	262
F185	LA9-FG600	78	158	238	102	182	262
F225	LA9-F22500	62	158	254	86	182	278
F265	LA9-FH600	100	196	292	120	216	312
F330/400	LA9-FJ600	107	203	299	127	223	319
F500	LA9-FK600	112	222	332	132	242	352
F630	LA9-FL600	137	297	457	157	317	477



WARNING:
Remember that electrical AND mechanical interlocking should always be preferred to ensure assembly reliability.



WARNING:
When no mechanical interlock is available, beware to add an electrical interlock with sufficient time delay to avoid short-circuit.

Components for 3P customer assemblies

Contactor types			Mechanical interlock included	Mechanical horizontal interlock
Line	Delta	Star		
LC1F115	LC1F115	LC1D80	LA9FF610	-
		LC1F115	LA9FF600	LA9FF970
LC1F150	LC1F150	LC1F115	LA9FG610	LA9FF970
		LC1F150	LA9F15000	LA9FF970
LC1F185	LC1F185	LC1F150	LA9F18517	-
		LC1F150	LA9FG610	-
		LC1F185	LA9FG600	LA9FG970
LC1F225	LC1F225	LC1F185	LA9F22510	LA9FG970
		LC1F225	LA9F22500	LA9FG970
LC1F265	LC1F265	LC1F185	LA9FH610	-
		LC1F265	LA9FH600	LA9FJ970
LC1F330	LC1F330	LC1F265	LA9FJ610	LA9FJ970
		LC1F330	LA9FJ600	LA9FJ970
LC1F400	LC1F400	LC1F265	LA9FJ610	-
		LC1F330	LA9FJ600	-
		LC1F400	LA9FJ600	LA9FJ970
LC1F500	LC1F500	LC1F500	LA9FK600	LA9FJ970
LC1F630	LC1F630	LC1F630	LA9FL600	LA9FJ970



LA9FF610



LA9FG610



LA9F18517



LA9FF600, G, H, K, ...
LA9FL600
LA9F15000



LA9F22510,
LA9FH610, LA9FJ610



LA9FF970..LA9FL970
Mechanical horizontal interlocks





Source or load changeover

A

4

Principle

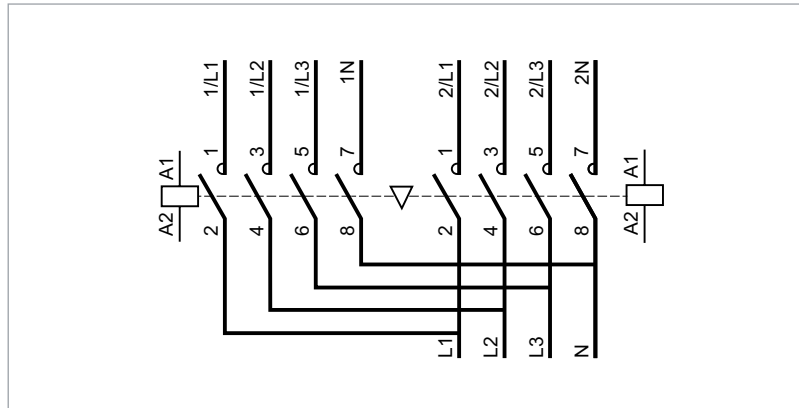

The changeover contactor assembly can be used for alternatingly switching a load circuit from a main to a secondary source. Loads permutation on a single source can also be achieved with the same assembly.

The changeover is composed of 2 identical 4-pole contactors when each of them must withstand the full load current. They are mechanically and electrically interlocked to prevent from simultaneous closing.

Note

Mechanical + electrical contactor interlocking should always be preferred for improved reliability.



Up to 20 A AC-1 - TeSys K

4-pole changeovers - screw clamp, spring terminals, Faston or solder pins

Pre-assembled

Blocks of TeSys K contactors on DIN rail (they cannot be separated)

- 4 NO power poles (AC-1 applications only)
- built-in mechanical interlock (LC2K contactor blocks only)
- AC or DC coil control
- standard or silent contactors
- screw clamp with electrical power links, spring, Faston or solder pins terminals.

LC2K••4

LC2K12004P7
Screw clamp terminals



LC2K••43••

LC2K090043E7
Spring terminals



LC2K••47••

LC2K120047B7
Faston connectors



LC2K••45••

LC2K120045P7
Solder pins



AC-1 rating *	Terminals references							
	Screw clamp with electrical power links		Spring*		Faston (1 x 6.35 or 2 x 2.8)		Solder pins for printed circuitboard	
(A)	Standard contactor	Silent contactor	Standard contactor	Silent contactor	Standard contactor	Silent contactor	Standard contactor	Silent contactor
AC coil control								
20	LC2K09004••	(1)	(1)	-	(1)	(1)	(1)	(1)
	LC2K12004••	(1)	(1)	-	(1)	(1)	(1)	(1)
DC coil control								
20	LP2K09004••	LP5K09004BW3 (2)	(1)	(1)	(1)	(1)	(1)	(1)
	LP2K12004••	LP5K12004BW3 (2)	(1)	(1)	(1)	(1)	(1)	(1)

(*) AC-1 rating limited to 10 A with spring terminals, 1.5 mm² cable max.

(1) Factory assembly on request

(2) For other voltage code, please contact your local sales representative

Coil voltage: replace 2 dots at end of commercial references by voltage code (P7 = 230 V 50-60 Hz; BD = 24 V DC; BW3 = 24 V DC low consumption; other codes, see page 44).

A

4

20 to 200 A AC-1 - TeSys D

4-pole changeovers - screw clamp terminals

Pre-assembled



LC2DT**

Delivered with:

- 4-pole contactors
- mechanical interlock.

AC-1	Terminals references
(A)	Assemblies with pre-wired electrical links
20	LC2DT20** ⁽¹⁾
25	LC2DT25** ⁽¹⁾
32	LC2DT32** ⁽¹⁾
40	LC2DT40** ⁽¹⁾
60	-
80	-
125	LC2D80004** ⁽¹⁾⁽²⁾
200	LC2D115004** ⁽³⁾

(1) Mechanical interlock without electrical interlocking

(2) Order separately 2 auxiliary contact blocks LADN.1 to obtain electrical interlocking between the 2 contactors

(3) Mechanical interlock with integral, pre-wired electrical interlocking

Coil voltage: replace 2 dots at end of commercial references by voltage code (P7 = 230 V 50-60 Hz; BD = 24 V DC; BW3 = 24 V DC low consumption; other codes, see page 48).

Components for customer assemblies

Contactors + dedicated kits for building complete load or source changeover assemblies.

Bill of material			
AC-1 rating	4 poles (NO) contactors	Kits (with or without interlocking devices) Separate interlocking devices	
(A)		Electrical power links	Interlocking devices
			Mechanical Electrical
20	2x LC1DT20**	Assembling kits: LADT9R1 electrical interlock not included or LADT9R1V electrical interlock (white power link) included	
25	2x LC1DT25**		
32	2x LC1DT32**		
40	2x LC1DT40**		
60	2x LC1DT60A**	Customer cabling	LAD4CM
80	2x LC1DT80A**		Customer cabling
125	2x LC1D80004** (~ coil) or 2x LP1D80004** (= coil)	LA9D8070	LA9D4002 (for LC1) LA9D8002 (for LP1)
200	2x LC1D115004**	LA9D11570	LA9D11502

Coil voltage: replace 2 dots at end of commercial references by voltage code (P7 = 230 V 50-60 Hz; BD = 24 V DC; BW3 = 24 V DC low consumption; other codes, see page 48).

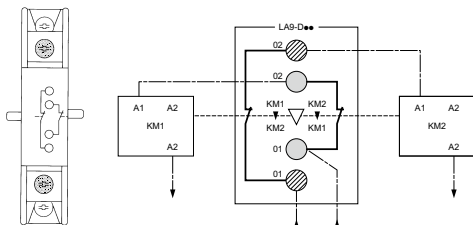

LA9D4002 - LA9D8002: interlocking module / wiring diagram

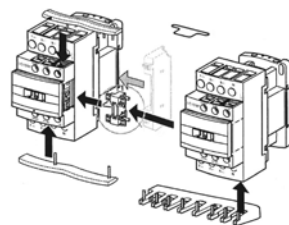

LADT9R1V Mechanical + electrical interlocking kit



LAD4CM
Mechanical interlock

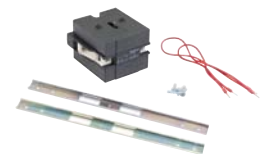

LA9D11502
Electro-mechanical interlocking



LA9D4002
Electro-mechanical interlocking for AC



LA9D8002
Electro-mechanical interlocking for DC



LADT9R1



LADT9R1V



LA9D11570



LA9D8070

20 to 200 A AC-1 - TeSys D

4-pole changeovers - screw terminals for lugs spring terminals

Pre-assembled



LC2DT256**



LC2DT203**

LC2DT**

Delivered with:

- 4-pole contactors
- mechanical interlock.

AC-1	Terminals references	
(A)	Screw for lugs	Spring
20	LC2DT206** ⁽¹⁾	LC2DT203** ⁽¹⁾⁽²⁾
25	LC2DT256** ⁽¹⁾	
32	LC2DT326** ⁽¹⁾	
40	LC2DT406** ⁽¹⁾	

(1) Mechanical interlock without electrical interlocking

(2) Power and control by Spring terminals

Coil voltage: replace 2 dots at end of commercial references by voltage code (P7 = 230 V 50-60 Hz; BD = 24 V DC; BW3 = 24 V DC low consumption; other codes, see page 48).

Components for customer assemblies

Contactors + dedicated kits for building complete load or source changeover assemblies.

Bill of material					
AC-1 rating	4 poles (NO) contactors		Kits (with or without interlocking devices) Separate interlocking devices		
(A)	Terminal type		Electrical power links	Interlocking devices	
	Screw for lugs or bars	Spring		Mechanical	Electrical
20	2x LC1DT206**	2x LC1DT203** ⁽²⁾	LADT3R1 Kit for spring terminals only, with power link (LAD9V9), mechanical interlocking (LAD9V2) and assembling staple (LAD9V7)		Customer cabling
25	2x LC1DT256**	2x LC1DT253** ⁽²⁾			
32	2x LC1DT326**	2x LC1DT323** ⁽²⁾			
40	2x LC1DT406**	2x LC1DT403** ⁽²⁾			
60	2x LC1DT60A6**	2x LC1DT60A3** ⁽¹⁾	Customer cabling	LAD4CM	Customer cabling
80	2x LC1DT80A6**	2x LC1DT80A3** ⁽¹⁾			
125	2x LC1D800046** (~) 2x LP1D800046** (DC)	-	Customer cabling	LA9D4002 (AC) / LA9D8002 (DC)	
200	2x LC1D1150046**	-	Customer cabling	LA9D11502	

(1) Power connection by EverLink® BTR screw connector's and control by spring terminals

(2) Power and control by Spring terminals.

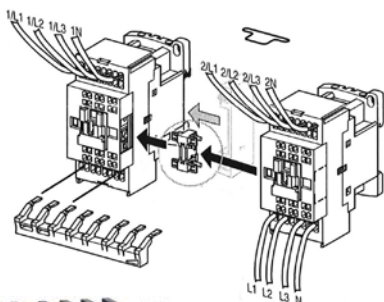

LADT3R1 (for spring terminals only)
Mechanical + electrical interlocking kit



LA9D8002
Electro-mechanical interlocking for DC



LA9D4002
Electro-mechanical interlocking for AC

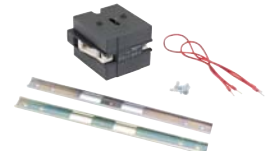

LA9D11502
Electro-mechanical interlocking



LAD4CM
Mechanical interlock

60 to 200 A AC-1 - TeSys D

3-pole changeovers - screw clamp terminals

Components for customer assemblies

2 identical contactors + dedicated kits for building complete load or source changeover assemblies.

Characteristics	Bill of material (contactors to be completed with...)			
AC-3 rating (A)	Contactors	Set of electrical power links	Mechanical interlocking	Electrical interlocking
40	2x LC1D40A** ⁽¹⁾	Kit: LAD9R3S: power links + mechanical interlock		Customer cabling
50	2x LC1D50A** ⁽¹⁾			
65	2x LC1D65A** ⁽¹⁾			
80	2x LC1D80**	Power links: LA9D80691	Mechanical + electrical interlocks: LA9D4002 for AC - LA9D8002 for DC	
95	2x LC1D95**			
115	2x LC1D115**	Power links: LA9D11571	Mechanical + electrical interlocks: LA9D11502	
150	2x LC1D150**			

(1) Power connection by EverLink® BTR screw connectors and control by screw clamp terminals
 Coil voltage: replace 2 dots at end of commercial references by voltage code (P7 = 230 V 50-60 Hz; BD = 24 V DC; BW3 = 24 V DC low consumption; other codes, see page 48).

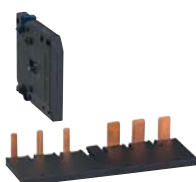

LAD9R3S
 Kit with mechanical interlock and 3P 65 A AC-3 power links



LA9D80691
 3P 95 A AC-3 power links



LA9D11571
 3P 150 A AC-3 power links



LA9D4002
 Electro-mechanical interlocking for 80-95 A AC-3



LA9D8002
 Electro-mechanical interlocking for 80-95 A AC-3

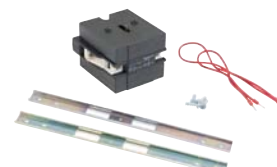

LA9D11502
 Electro-mechanical interlocking

200 to 1000 A AC-1 - TeSys F

3-pole, 4-pole changeovers - screw terminals for lugs or bars

Pre-assembled



LC2DF..

Delivered with:

- 4-pole contactors
- mechanical interlock
- pre-wired power connections.

Contactor types (pair of 2 identical)	References
LC1F115	LC2F1154
LC1F150	LC2F1504
LC1F185	LC2F1854
LC1F225	LC2F2254
LC1F265	LC2F2654

Coils to be ordered separately – see commercial references in TeSys catalogue chapter B9.

Components for customer horizontal assemblies

Bill of material						
Contactor types (pair of 2 identical)	3-pole contactors assemblies			4-pole contactors assemblies		
	Contactors	Set of electrical power links	Horizontal mechanical interlock	Contactors	Set of electrical power links	Horizontal mechanical interlock
LC1F115	2x LC1F115	LA9FF982	LA9FF970	2x LC1F1154	LA9FF977	LA9FF970
LC1F150	2x LC1F150	LA9F15082		2x LC1F1204	LA9F15077	
LC1F185	2x LC1F185	LA9FG982	LA9FG970	2x LC1F1854	LA9FG977	LA9FG970
LC1F225	2x LC1F225	LA9F22582		2x LC1F2254	LA9F22577	
LC1F265	2x LC1F265	LA9FH982	LA9FJ970	2x LC1F2654	LA9FH977	LA9FJ970
LC1F330	2x LC1F330	LA9FJ982		2x LC1F3304	LA9FJ977	
LC1F400	2x LC1F400	LA9FJ982		2x LC1F4004		
LC1F500	2x LC1F500	LA9FK982		2x LC1F5004	LA9FK977	
LC1F630	2x LC1F630	LA9FL982	LA9FL970	2x LC1F6304	LA9FL977	LA9FL970
LC1F800	2x LC1F800	LA9FL982		-	-	

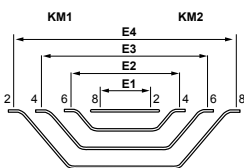

KM1 = KM2		E1	E2	E3	E4
LC1F1154	LA9FF977	77	151	225	299
LC1F1504	LA9F15077	71	151	231	311
LC1F1854	LA9FG977	78	158	238	318
LC1F2254	LA9F22577	54	150	246	342
LC1F2654	LA9FH977	100	196	292	388
LC1F3304/4004	LA9FJ977	107	203	299	395
LC1F5004	LA9FK977	112	222	332	442
LC1F6304	LA9FL977	137	297	457	617

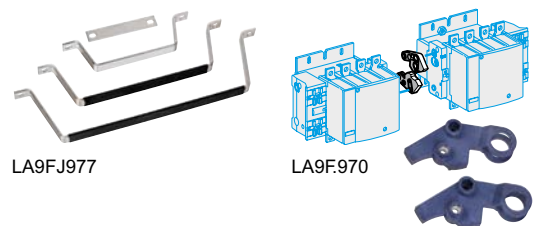

Vertical customer assembly

The vertical mechanical interlocks must be substituted by horizontal. Electrical power and interlocking circuits shall be wired by customer (no pre-fabricated links available).

Customer assembly of pairs of contactors of different ratings

Contactors of different ratings (3 or 4 poles) can be only vertically assembled. Selection tables of appropriate mechanical interlocks (no pre-fabricated links available) can be found in the TeSys catalogue ref. MKTED210011EN - chapter B9 (page 38-39 of 2017-2018 edition).

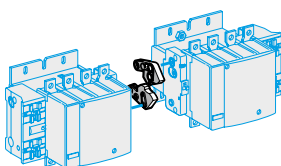

Mechanical interlocks for horizontal assembling of identical contactors.

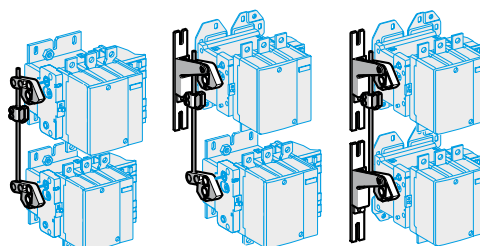

Interlocks are different, depending on the ratings to be associated (only vertically).



Part B: contactors & accessories

B

TeSys K

5

TeSys D

6

TeSys F

7

TeSys K



Simple, robust and compact contactors, 3 or 4 poles, from 6 to 16 A AC-3, 20 A AC-1 (10 A AC-1 with spring terminals)



With screw clamp terminals



With spring terminals



With Faston connectors



With solder pins



With screws for lugs

Electrodomestic applications:
TeSys D, K 'S335' series contactors

Railways applications:
TeSys D, K 'S207' series contactors

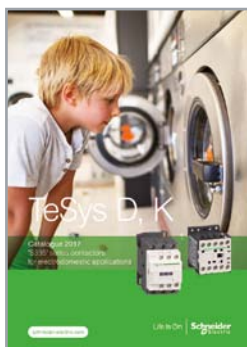

Catalogue 2017
Ref.: LVCATDESDK335_EN



Scan or click on QR code to reach the portal

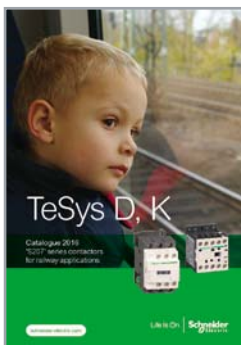

Catalogue 2016
Ref.: LVCATRAIL_EN



Scan or click on QR code to reach the portal

Commercial references coding



Contactor type

LC1: 3P – AC coil
LC2: Reverser (2 contactor assembly) – 3P – AC coil
LC3: Star-Delta (3 contactor assembly) – 3PLC7: 3P – silent AC coil
LC8: Reverser (2 contactor assembly) – 3P – silent AC coil
LP1: 3P – AC coil
LP2: Reverser (2 contactor assembly) – 3P – DC coil
LP4: 3 or 4P – Low consumption DC coil
LP5: Reverser (2 contactor assembly) – 3 or 4P – Low consumption DC coil

AC-3 rating (A)

06, 09, 12 or 16

Instantaneous auxiliary contacts

00	No auxiliary contacts
10	1 NO
01	1 NC

Number of power poles

Not specified	3 NO
4	4 NO
8	2 NO + 2 NC

Terminal type

Not specified	screws clamp terminals
3	spring terminals
5	solder pins for printed circuit boards
6	screws for lugs
7	Faston terminals

Coil voltage code

a.c. supply

Contactors LC1 K (0.8... 1.15 Uc) (0.85... 1.1 Uc)

Volts	12	20	24 ⁽²⁾	36	42	48	110	115	120	127	200/208	-	220/230	230	230/240
50/60 Hz	J7	Z7	B7	C7	D7	E7	F7	FE7	G7	FC7	L7		M7	P	U7
Volts	256	277	380/400	-	400	400/415	-	440	480	500	575	600	660/690	-	-
50/60 Hz	W7	UE7	Q7	-	V7	N7	-	R7	T7	S7	SC7	X7	Y7	-	-

Up to and including 240 V, coil with integral suppression device available: add 2 to the code required. Example: J72

Contactors LC7 K (0.8... 1.1 Uc)

Volts	24	42	48	110	115	220	230/240
50/60 Hz	B7	D7	E7	F7	FE7	M7	U7

d.c. supply

Contactors LP1 K (0.8... 1.15 Uc)

Volts	12	20	24 ⁽²⁾	36	48	60	72	100	110	125	155	174	200	220	230	240	250
Code	JD	ZD	BD	CD	ED	ND	SD	KD	FD	GD	PD	QD	LD	MD	MPD	MUD	UD

Coil with integral suppression device available: add 2 to the code required. Example: JD3

Low consumption

Contactors LP4 K (0.7... 130 Uc)

Volts	12	20	24	48	72	110	120
Code	JW3	ZW3	BW3	EW3	SW3	FW3	GW3

B

5

Commercial references per terminal type

TeSys K contactors fulfill a large variety of customer's needs thanks to their compactness and multiple declinations:

- 5 terminal types
- AC, DC, low consumption DC coils (for control by PLC output)
- standard or silent contactors.

Check for details and variant availabilities in TeSys catalogue ref. MKTED210011– chapter B8.

3 and 4 pole TeSys K contactors

Screw clamp terminals



LC1K0901..

Spring terminals



LC1K09013..

Faston connectors



LC1K09017..

Solder pins



LC1K09015..

Screws for lugs



LC1K9016..

AC3 rating	AC1 rating	Power contacts		Auxiliary contacts		Screw clamp connections		Spring terminals		Faston connectors (1 x 6.35 or 2 x 2.8)		Solder pins for printed circuitboard		Lugs
		NO	NC	NO	NC	General purpose	Silent contactor	General purpose	Silent contactor	General purpose	Silent contactor	General purpose	Silent contactor	
(A)		NO	NC	NO	NC									
AC supply of control circuit						General purpose	Silent contactor	General purpose	Silent contactor	General purpose	Silent contactor	General purpose	Silent contactor	General purpose
6	-	3	-	1	-	LC1K0610	LC7K0610**	LC1K06103**	-	LC1K06107**	LC7K06107**	LC1K06105**	LC7K06105**	LC1K06106**
	-	3	-	-	1	LC1K0601**	LC7K0601**	LC1K06013**	-	LC1K06017**	LC7K06017**	LC1K06015**	LC7K06015**	LC1K06016**
9	20*	3	-	1	-	LC1K0910**	LC7K0910**	LC1K09103**	-	LC1K09107**	LC7K09107**	LC1K09105**	LC7K09105**	LC1K09106**
	20*	3	-	-	1	LC1K0901**	LC7K0901**	LC1K09013**	-	LC1K09017**	LC7K09017**	LC1K09015**	LC7K09015**	LC1K09016**
-	20*	4	-	-	-	LC1K09004**	LC7K09004**	LC1K090043**	-	LC1K090047**	LC7K090047**	LC1K090045**	LC7K090045**	-
	20*	2	2	-	-	LC1K09008**	LC7K09008**	LC1K090083**	-	LC1K090087**	LC7K090087**	LC1K090085**	LC7K090085**	-
12	20*	3	-	1	-	LC1K1210**	LC7K1210**	LC1K12103**	-	LC1K12107**	LC7K12107**	LC1K12105**	LC7K12105**	LC1K12106**
	20*	3	-	-	1	LC1K1201**	LC7K1201**	LC1K12013**	-	LC1K12017**	LC7K12017**	LC1K12015**	LC7K12015**	LC1K12016**
-	20*	4	-	-	-	LC1K12004**	LC7K12004**	-	-	LC1K120047**	LC7K120047**	LC1K120045**	LC7K120045**	-
16	-	3	-	1	-	LC1K1610**	-	-	-	LC1K16107**	-	LC1K16105**	-	LC1K16106**
	-	3	-	-	1	LC1K1601**	-	-	-	LC1K16017**	-	LC1K16015**	-	LC1K16016**
DC supply of control circuit						General purpose	Low consumption	General purpose	Low consumption	General purpose	Low consumption	General purpose	Low consumption	General purpose
6	-	3		1		LP1K0610**	LP4K0610**	LP1K06103**	LP4K06103**	LP1K06107**	LP4K06107**	LP1K06105**	LP4K06105**	LP1K06106**
	-	3			1	LP1K0601**	LP4K0601**	LP1K06013**	LP4K06013**	LP1K06017**	LP4K06017**	LP1K06015**	LP4K06015**	LP1K06016**
9	20*	3		1		LP1K0910**	LP4K0910**	LP1K09103**	LP4K09103**	LP1K09107**	LP4K09107**	LP1K09105**	LP4K09105**	LP1K09106**
	20*	3			1	LP1K0901**	LP4K0901**	LP1K09013**	LP4K09013**	LP1K09017**	LP4K09017**	LP1K09015**	LP4K09015**	LP1K09016**
-	20*	4	-	-	-	LP1K09004**	LP4K09004**	LP1K090043**	LP4K090043**	LP1K090047**	LP4K090047**	LP1K090045**		-
	20*	2	2	-	-	LP1K09008**	LP4K09008**	LP1K090083**	LP4K090083**	LP1K090087**	LP4K090087**	LP1K090085**		-
12	20*	3		1		LP1K1210**	LP4K1210**	LP1K12103**	LP4K12103**	LP1K12107**	LP4K12107**	LP1K12105**	LP4K12105**	LP1K12106**
	20*	3			1	LP1K1201**	LP4K1201**	LP1K12013**	LP4K12013**	LP1K12017**	LP4K12017**	LP1K12015**	LP4K12015**	LP1K12016**
-	20*	4	-	-	-	LP1K12004**	LP4K12004**	LP1K120043**	LP4K120043**	LP1K120047**	LP4K120047**	LP1K120045**	LP4K120045**	-

* AC1 rating limited to 10 A with spring terminals (max. cable: 1.5 mm²).

Coil voltage: replace 2 dots at end of commercial references by voltage code (P7 = 230 V 50-60 Hz; BD = 24 V DC; BW3 = 24 V DC low consumption; other codes, see page 44)

Connection accessories

Terminal adaptors - Pole interconnection links

For
 LC1K06... LC1K16
 LC7K06... LC7K12
 LP1K06... LP1K12
 LP4K06... LP4K12



Solder pins adaptor for top terminals
LA9K105S Lot of 100

For 4P contactors with screw terminals for lugs. Solder pins allow every terminal to be linked to a printed circuit board or to an individual cable.



Solder pins adaptor for bottom terminals
LA9K105I Lot of 100

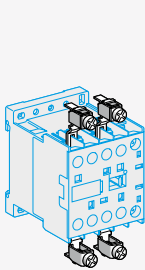

2-pole parallel link
LA9E1 Lot of 4

For contactors with screw clamp terminals. Connects 2 poles in parallel. Can be used for increasing the current switching capability. Used to make/break a current higher than the pole rated capacity.



4-pole parallel link
LA9E2 Lot of 4

For contactors with screw clamp terminals. Connects 4 poles in parallel. Can be used for increasing the current switching capability. Used to make/break a current higher than the pole rated capacity.



Parallel + reverser links kit
LA9K0969

For 3P contactors with screw clamp terminals. Used for motor reverser starter.

B

5

TeSys D



Reliable and long-lasting contactors, 3 or 4 poles, from 6 to 16 A AC-3, 20 A AC-1 (10 A AC-1 with spring terminals)

A choice of terminal types



Screw clamp terminals



EverLink[®] terminals, with constant tightening



Screw terminals, for lugs or bars



Faston terminals

Different size, according to rating:



9 to 38 A AC-3:
LC1D09, D12, D18, D25, D32, D38



40 to 65 A AC-3:
LC1D40, D50, D65 LC1DT60A, DT80A



80 to 95 A AC-3:
LC1D80, D95 LC1D80004, LC1D80008, LC1D4008, LC1D65008



115 to 150 A AC-3:
LC1D115, D150 LC1D115005

Electrodomestic applications:
TeSys D, K 'S335' series contactors

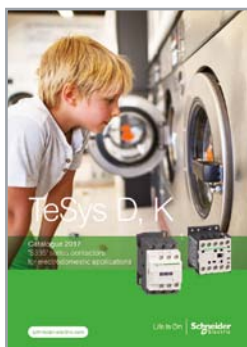

Catalogue 2017
Ref.: LVCATDESDK335_EN



Scan or click on QR code to reach the portal

Railways applications:
TeSys D, K 'S207' series contactors

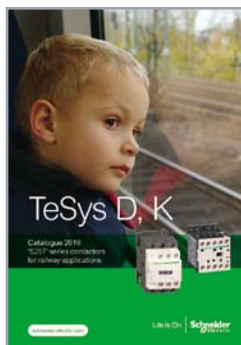

Catalogue 2016
Ref.: LVCATRIL_EN



Scan or click on QR code to reach the portal

Commercial references coding

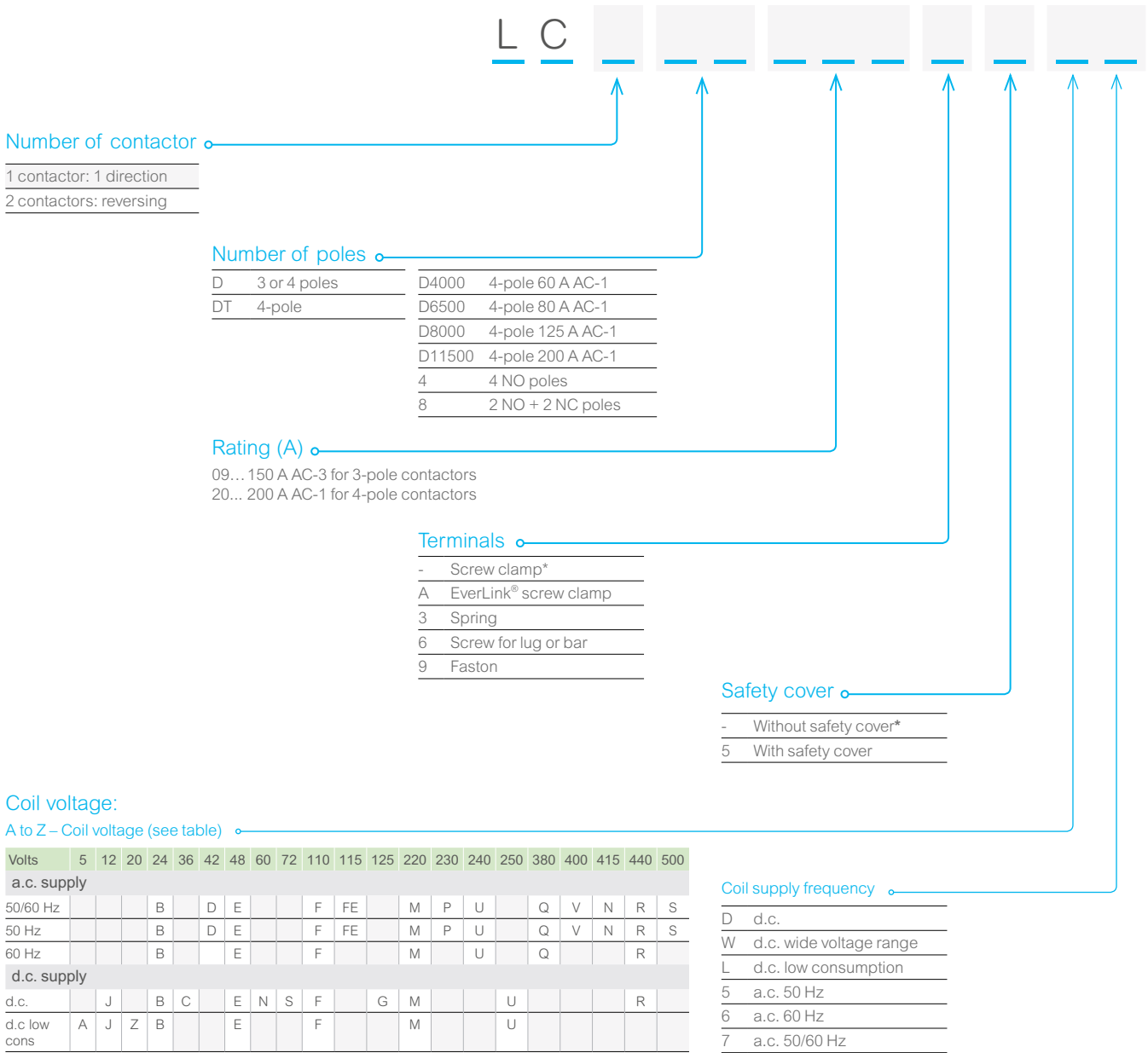

*No specific code displayed in the reference.

Exemples

LC 1 D 40 A - BD

1 contactor • 3-pole • 40 A • EverLink® screw clamp terminals • Without safety cover • 24 V • dc coil
Corresponding reference: **LC1D40ABD**

LC 1 D8000 4 - - P7

1 contactor • 4-pole • 125 A • Screw clamp terminals • Without safety cover • 230 V • 50/60 Hz ac coil
Corresponding reference: **LC1D80004P7**

Note

Contactors exist for most of possible combinations.
Check for availability before ordering.



Commercial references per terminal type

TeSys D contactors fulfill a large variety of customer's needs thanks to their multiple declinations, accessories and auxiliaries:

- 5 terminal types
- AC, DC, Low Consumption DC coils, electronic coils (TeSys D Green for control by PLC output).

Check for details, accessories, auxiliaries in TeSys catalogue ref. MKTED210011– chapter B.

3 and 4-pole TeSys D contactors



AC3 rating	AC1 rating	Power contacts		Auxiliary contacts		Screw clamp terminals or EverLink® connectors	Lugs or bars	Spring terminals	Faston connectors
		NO	NC	NO	NC				
(A)									
9	16	3	-	1	1			LC1D093** ⁽⁴⁾	
	25	3	-	1	1	LC1D09** ⁽¹⁾	LC1D096**		LC1D099** ⁽⁶⁾
	20	4	-	1	1	LC1DT20** ⁽¹⁾	LC1DT206**	LC1DT203** ⁽⁴⁾	
12	25	2	2	1	1	LC1D098** ⁽¹⁾	LC1D0986**	LC1D0983** ⁽⁴⁾	
		3	-	1	1	LC1D12** ⁽¹⁾	LC1D126**	LC1D123** ⁽⁴⁾	
		4	-	1	1	LC1DT25** ⁽¹⁾	LC1DT256**	LC1DT253** ⁽⁴⁾	
		2	2	1	1	LC1D128** ⁽¹⁾	LC1D1286**	LC1D1283** ⁽⁴⁾	
18	25	3	-	1	1			LC1D183** ⁽⁴⁾	
	32	3	-	1	1	LC1D18** ⁽¹⁾	LC1D186**		-
		4	-	1	1	LC1DT32** ⁽¹⁾	LC1DT326**	LC1DT323** ⁽⁴⁾	
25	40	2	2	1	1	LC1D188** ⁽¹⁾	LC1D1886**	LC1D1883** ⁽⁴⁾	
		3	-	1	1	LC1D25** ⁽¹⁾	LC1D256**	LC1D253** ⁽⁴⁾	
		4	-	1	1	LC1DT40** ⁽¹⁾	LC1DT406**	LC1DT403** ⁽⁴⁾	
		2	2	1	1	LC1D258** ⁽¹⁾	LC1D2586**	LC1D2583** ⁽⁴⁾	
32	25	3	-	1	1			LC1D323** ⁽⁴⁾	
	50	3	-	1	1	LC1D32** ⁽¹⁾	LC1D326**		-
38	38	3	-	1	1			LC1D383 ⁽⁴⁾	
	50	3	-	1	1	LC1D38** ⁽¹⁾	LC1D386**		-
40	60	3	-	1	1	LC1D40A** ⁽²⁾	LC1D40A6**	LC1D40A3** ⁽⁵⁾	-
	60	4	-	1	1	LC1DT60A** ⁽²⁾	LC1DT60A6**	LC1DT60A3** ⁽⁵⁾	
		2	2	1	1	LC1D40008** (~ coil) LP1D40008** (= coil)	LC1D400086** (~ coil) LP1D400086** (= coil)		
50	80	3	-	1	1	LC1D50A** ⁽²⁾	LC1D50A6**	LC1D50A3** ⁽⁵⁾	-
65	80	3	-	1	1	LC1D65A** ⁽²⁾	LC1D65A6**	LC1D65A3** ⁽⁵⁾	-
	80	4	-	1	1	LC1DT80A** ⁽²⁾	LC1DT80A6**	LC1DT80A3** ⁽⁵⁾	
		2	2	1	1	LC1D65008** (~ coil) LP1D65008** (= coil)	LC1D650086** (~ coil) LP1D650086** (= coil)		
80	125	3	-	1	1	LC1D80** ⁽³⁾	LC1D806**	-	-
	125	4	-	1	1	LC1D80004** (~ coil) LP1D80004** (= coil) ⁽³⁾	LC1D800046** (~ coil) LP1D800046** (= coil)		
		2	2	1	1	LC1D80008** (~ coil) LP1D80008** (= coil)	LC1D800086** (~ coil) LP1D800086** (= coil)		
95	125	3	-	1	1	LC1D95** ⁽³⁾	LC1D956**	-	-
115	200	3	-	1	1	LC1D115** ⁽³⁾	LC1D1156**	-	-
-	200	4	-	1	1	LC1D115004** ⁽³⁾	LC1D1150046**		
150	200	3	-	1	1	LC1D150** ⁽³⁾	LC1D1506**	-	-

Coil voltage: replace 2 dots at end of commercial references by voltage code (P7 = 230 V 50-60 Hz; BD = 24 V DC; BW3 = 24 V DC low consumption; other codes, see page 48)

(1) Connection by screw clamp terminals

(2) Power connection by EverLink® BTR screw connectors and control by screw clamp terminals

(3) Connection by screw clamp terminal or connectors

(4) Power and control by spring terminals

(5) Power connection by EverLink® BTR screw connectors and control by spring terminals

(6) Contactors fitted with 2 x 6.35 mm Faston connectors on power poles and 1 x 6.35 mm on coil and auxiliary terminals.

Connection accessories

Terminal adaptors for 3P contactors

For LC1D09...
D38



Terminal adaptor
for 25 mm² cables
LA9D3260

Lot of 1

To be inserted into 3P contactor screw clamp or screw type terminals. Keeps wires in the right order when removing/reinstalling a contactor.



Terminals for parallel
connection
LA9D1261

Lot of 10

For connecting one single cable into 2 terminals in parallel.

For LC1D40A...
D65A



EverLink® terminal
block
LAD96560

Lot of 1

Spare EverLink® terminal for compatible contactors.

For LC1D40A...
D80A



Wiring adaptor
LAD4BB3

Lot of 1

Used when an old contactor must be replaced by today's TeSys D. The existing coil top wiring is generally too short, this adaptor provides extra length to allow new front coil connection.

For LC1D40A6...
D65A6



3P terminal protective
cover
LAD96570

Lot of 1

To be inserted on screw type terminal (for lugs) of contactors. Prevents contact with live parts.

For LC1D80...
D95



Control circuit take-off
from main pole
LA9D8067

Lot of 10

To be inserted into a power screw clamp terminal, it provides a smaller terminal for a control circuit connected to the same voltage.

For LC1D115...
D150



Control circuit take-off
from main pole
LA9D11567

Lot of 10

To be inserted into a power screw clamp terminal, it provides a smaller terminal for a control circuit connected to the same voltage



Terminal blocks
for 120 mm² cables
LA9D115603

Lot of 2

For changing contactors with simple screw-type terminals into screw clamp terminals

For LC1D115...
D150



Connector blocks
for lug terminals
LA9D115503

Lot of 2

Hold the ring lugs in place when connected to a contactor with simple screw-type terminals.



Spreaders for
power poles
GV7AC03

Lot of 3

To be connected to a contactor with screw type terminals (for lugs), for increasing pole pitch to 45 mm.



Terminal protective
covers
LA9D115703

Lot of 6

To be inserted on screw type terminals (for lugs) of contactors. 1 cover per pole. Prevent contact with live parts.

B

6

Connection accessories

Terminal interconnection links for 3P contactors

For LC1D09... D38

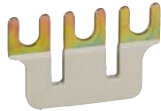

3P parallel links
LA9D1262

Lot of 10

Used for linking 3 poles of a contactor used in a star/delta starter, as an example.



3P parallel links
LAD9P3

Lot of 10

Used for linking 3 poles of a contactor used in a star/delta starter, as an example.

For LC1D40... D65



2P parallel links
LA9D40961

Lot of 2

For connecting one single cable with a ring lug into 2 contactor terminals in parallel.



2P parallel link
LAD9P32

Lot of 1

For connecting one single cable with a ring lug into 2 contactor terminals in parallel.



3P parallel link with warning cover
LAD9SD3S

Lot of 1

Used for linking 3 poles of a contactor used in a star/delta starter, as an example.



3P parallel link
LAD9P33

Lot of 1

For connecting one single cable with a ring lug into 3 contactor terminals in parallel.

For LC1D80... D95



2P parallel link
LA9D80961

Lot of 2

For connecting one single cable with a ring lug into 2 contactor terminals in parallel.



3P parallel link
LA9D80962

Lot of 1

For connecting one single cable with a ring lug into 3 contactor terminals in parallel.

Connection accessories

Pole interconnection links for a pair of 3P contactors

For LC1D09... D38 screw clamp terminals



Compact parallel link between 2 contactors
LAD9V5

Used upstream in reverser starters – High compactness, leaves a space for inserting a cable in each terminal.



Reverser link between 2 contactors
LAD9V6

Used downstream in reverser starters – High compactness.

For LC1D09... D38 screw clamp or spring terminals



Compact parallel link between 2 contactors
LAD9V10

Used upstream in reverser starters with spring or screw clamp terminal contactors. Must be used when a Quick power connection module - LAD341- is used to connect their top terminals to a circuit breaker.

For LC1D09... D38 spring terminals



Parallel link between 2 contactors
LAD9V12

Used upstream in reverser starters, without Quick power connection module - LAD341.



Compact reverser link between 2 contactors
LAD9V11

Used downstream in reverser starters with spring terminal contactors. Must be used when a Quick power connection module - LAD341- is used to connect their terminals to a circuit breaker.



Reverser link between 2 contactors
LAD9V13

Used downstream in reverser starters. For reverser connection of 2 contactors with spring terminals, without Quick power connection module - LAD341.

For LC1D40A... D65A screw clamp terminals



Compact parallel link between 2 contactors
LA9D65A6

Used upstream in reverser starters. Molded electrical link goes into a contactor cavity for better compactness.

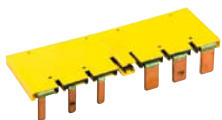

Compact reverser link between 2 contactors
LA9D65A9

Used downstream in reverser starters. Molded electrical link goes into a contactor cavity for better compactness.

Quick electrical link finder

Type	Screw clamp terminals	Spring terminals	EverLink® terminal
3-pole contactors	LC1D09... LC1D38	LC1D09... LC1D38	LC1D40A... LC1D65A
Parallel link		LAD9V12	
Parallel compact link	LAD9V5 and LAD9V10	LAD9V10	LA9D65A6
Reverser link		LAD9V13	
Reverser compact link	LAD9V6	LAD9V11	LA9D65A9

B

6

Connection accessories

Terminal adaptors - Pole interconnection links for 4P contactors

For LC1DT20...
DT25

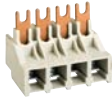

Terminal adaptor
for 10 mm² cables
LA9D1260

Lot of 1

To be inserted into 4P contactor screw clamp or screw type terminals. 90° connection angle between cable and contactor terminal.



1 terminal adaptor
for 10 mm² cables
LA9D2560

Lot of 1

To be inserted into 4P contactor screw clamp or screw type terminals. Straight connection between cable and connector terminal.



Terminal for 2P
parallel connection
LA9D1261

Lot of 10

For connecting one single cable into 2 terminals in parallel.



1 terminal for
parallel connection
LA9D1263

Lot of 2

For connecting one single cable with a ring lug into 4 terminals in parallel.



1 terminal for 2P
parallel connection
LA9D2561

Lot of 10

For connecting one single cable into 2 terminals in parallel.



1 terminal for 4P
parallel connection
LA9D2563

Lot of 1

For connecting one single cable into 4 terminals in parallel.

For LC1DT40...
DT65



2P parallel links
LA9D40961

Lot of 2

For connecting one single cable with a ring lug into 2 terminals in parallel.



4P parallel links
LA9D40963

Lot of 2

For connecting one single cable with a ring lug into 4 terminals in parallel.

For LC1D60A6...
D80A6



4P terminal
protective cover
LAD96580

Lot of 1

To be inserted on screw type terminal (for lugs) of contactors. Prevents from direct contact with live lugs.

For LC1DT80...
DT95



Control circuit take-off
from main pole
LA9D8067

Lot of 10

To be inserted into a power screw clamp terminal, it provides a smaller terminal for a control circuit connected to the same voltage.

Connection accessories

Terminal adaptors - Pole interconnection links for 4P contactors

For LP1D80



2P parallel links
LA9D80961

Lot of 2

For connecting one single cable with a ring lug into 2 terminals in parallel.



4P parallel links
LA9D80963

Lot of 2

For connecting one single cable with a ring lug into 4 terminals in parallel.

For LC1D80004,
LC1D80008,
LC1D115004



Control circuit take-off from main pole
LA9D11567

Lot of 10

To be inserted into a power screw clamp terminal, it provides a smaller terminal for a control circuit connected to the same voltage.

For LC1D115...
D150



4P terminal blocks for 120 mm² cables
LA9D115604

Lot of 2

For changing contactors with simple screw-type terminals into screw clamp terminals.

For LC1D1156...
D1506



4P terminal blocks for ring lugs
LA9D115504

Lot of 2

Hold the ring lugs in place when connected to a contactor with simple screw-type terminals.



1P terminal protective cover
LA9D115704

Lot of 8

To be inserted on screw the type terminals (for lugs) of contactors. 1 cover per pole.

B

6

Connection accessories

Pole interconnection kits for a pair of contactors - Motor reverser

For LC1D09... D38



Motor reverser / Load changeover electrical interlocking links
LAD9V1

To be used with 2 contactors of same dimensions aligned on a single rail. Connect auxiliary contacts and coils circuits.



Motor reverser assembling kit (with mechanical interlock only)
LAD9R1

To be used with 2 contactors.



Motor reverser assembling kit (with mechanical and electrical interlock)
LAD9R1V

To be used with 2 contactors.

For LC1D40A, 50A... 65A



Motor reverser assembling kit (with mechanical interlock only)
LAD9R3

To be used with 2 contactors.

For LC1D80... D95



Motor reverser cabling kit
LA9D8069

To be used with 2 contactors.



Motor reverser mechanical interlocking kit
LA9D50978

To be used with 2 AC coil contactors.



Motor reverser mechanical interlocking kit
LA9D80978

To be used with 2 DC coil contactors.



Motor reverser mechanical and electrical interlocking kit
LA9D4002

To be used with 2 AC coil contactors.



Motor reverser mechanical and electrical interlocking kit
LA9D8002

To be used with 2 DC coil contactors.

For LC1D115... D150



Motor reverser cabling kit
LA9D11569

To be used with 2 contactors.

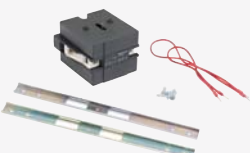

Motor reverser mechanical and electrical interlocking kit
LA9D11502

To be used with 2 contactors.

Connection accessories

Pole interconnection kit for a pair of contactors - Motor reverser + 2 speed control

For LC1D09... D25



Motor reverser + 2 speed assembling kit (with mechanical and electrical interlock)

LAD9PVGV

Provides the front faces alignment of a D09... D12. To be used with 3 contactors.

Pole interconnection kits for 3 contactors - Star Delta starter

For LC1D09... D38
Line contactor
(all contactors of same dimensions)



Motor Star Delta starter assembling kit (without timer)
Mechanical + electrical interlocks

LAD91218

To be used with 3 contactors of same dimensions aligned on a single rail.



Motor Star Delta starter assembling kit (with timer)
Mechanical + electrical interlocks

LAD91217

To be used with 3 contactors of same dimensions aligned on a single rail.



Motor Star Delta starter assembling kit (with timer)
Mechanical + electrical interlocks

LAD912GV

The starter is one block composed of GV2 circuit breaker + 1 contactor on the top row, and 2 contactors on the bottom row.



Motor Star Delta starter
Electrical interlocking links

LAD9V14

To be used with 3 contactors of same dimensions aligned on a single rail. Connect auxiliary contacts and coils circuits.

For LC1D25... D32
Line contactor
(smaller Star contactor (depth))



Motor Star Delta starter assembling kit (without timer)
Mechanical + electrical interlocks

LAD93218

To be used with 3 contactors aligned on a single rail. A raiser adaptor is provided for the Star contactor, smaller than other contactors.



Motor Star Delta starter assembling kit (with timer)
Mechanical + electrical interlocks

LAD93217

To be used with 3 contactors aligned on a single rail. A raiser adaptor is provided for the Star contactor, smaller than other contactors.

For LC1D40A... D65A
Line contactor



Motor Star Delta starter assembling kit (with timer)
Mechanical interlock

LAD9SD3

To be used with 3 contactors with EverLink terminals, aligned on a single rail.

For LC1D80
Line contactor
With LCD60 or D65 as Star contactor



Motor Star Delta starter assembling kit (with timer)
Mechanical interlock

LA9D8017

To be used with 3 contactors aligned on a single rail. No interlock provided, additional electrical interlocking circuit must be wired by customer.

For LC1D80, D95
Line contactor



Motor Star Delta starter assembling kit (with timer)
Mechanical interlock

LA9D8018

To be used with 3 contactors aligned on a single rail. Additional electrical interlocking circuit must be wired by customer.

B

6

Connection accessories

Pole interconnection kits for 3 contactors - Star Delta starter (see allocation table page 30)

For LC1D115
Line contactor



Motor Star Delta starter
cabling kit
LA9D11517

To be used with 3 contactors of same dimensions aligned on a single rail provided. Additional electrical interlocking circuit must be cabled by customer.

For LC1D150
Line contactor



Motor Star Delta starter
cabling kit
LA9D15017

To be used with 3 contactors of same dimensions aligned on a single rail provided. Possible addition of LA9D11502 mechanical + electrical interlocking kit.

Pole interconnection kits for a pair of 4-pole contactors - Load/Source changeover

For LC1DT20,
DT25, DT32, DT40



Changeover assembling kit
with mechanical interlock
LADT9R1

To be used with 2 contactors of same dimensions aligned on a single rail provided. Additional electrical interlocking circuit must be wired by customer.



Changeover assembling kit
with mechanical +
electrical interlocks
LADT9R1V

To be used with 2 contactors of same dimensions aligned on a single rail provided.

Pole interconnection kits for a pair of 3-pole contactors - Load/source changeover

For LC1D40A,
50A, 65A

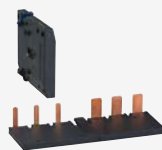

Kit with mechanical interlock
and 3P 65 A AC-3 power links
LA9DR3S

Pole parallel connection
(L1 connected to L1, L2 to L2...)

For LC1D80,
LC1D95



3P changeover 95 A AC-3
power link
LA9D80691

Pole parallel connection
(L1 connected to L1, L2 to L2...)

For LC1D115,
LC1D150



3P changeover 150 A AC-3
power link
LA9D11571

Pole parallel connection
(L1 connected to L1, L2 to L2...)

3-pole, 4-pole contactors - Electrical interlocking kit

For LC1DT20,
DT25, DT32, DT40



Motor reverser / Load changeover
electrical interlocking links
LAD9V1

To be used with 2 contactors of same dimensions aligned on a single rail. Connect auxiliary contacts and coils circuits.

Connection accessories

3 and 4-pole contactors - Mechanical assembly components

LC1D09... D12		Wedge for D09... D12 contactor LAD9V16	Allows front face alignment of a smaller contactor (LC1D09... D12) with a bigger contactor (LC1D25... D38).
LC1D09... D38		Mechanical interlock with staples LAD9V2	To be mounted between 2 contactors. Staples allow 2 contactors to be assembled in one block.
		Staple LAD9V17	For assembling 2 contactors in one block (reverser and other applications).
LC1D40A... D65A LC1DT60A... DT80A		Mechanical interlock LAD4CM	To be mounted between 2 contactors.

Quick interlocking kit finder

	LC1D09	LC1D12	LC1D18	LC1D25	LC1D32	LC1D38	LC1D40A	LC1D50A	LC1D65A	LC1D80	LC1D95	LC1D115	LC1D150		
LC1D09	Elec.: LAD9V1 Mecha.: LAD9V2		Elec.: LAD9V1 Mecha.: LAD9V2 + wedge LAD9V16												
LC1D12															
LC1D18															
LC1D25	Elec.: LAD9V1 Mecha.: LAD9V2 + wedge LAD9V16		Elec.: LAD9V1 Mecha.: LAD9V2												
LC1D32															
LC1D38															
LC1D40A						Meca.: LAD4CM									
LC1D50A															
LC1D65A															
LC1D80									Meca.: LA9D50978 (-) / LA9D80978 (DC) Electro-Meca.: LA9D4002 (-) / LAD8002 (DC)						
LC1D95															
LC1D115											Electro-Meca.: LA9D11502				
LC1D150															

B

6

TeSys F



Very high power handling and long-lasting contactors, 3 or 4 poles, from 115 to 1 000 A AC-3, 200 to 2600 A AC-1

LC1F630
630 A AC-3, 3 poles

Different size, according to rating and number of poles



500 A AC-1, 2 poles
LC1F4002



225 A AC-3, 3 poles
LC1F225



1 000 A AC-3, 3 poles
LC1F1700



1 000 A AC-3, 3 poles
LC1F2600



700 A AC-1, 4 poles
LC1F5004



1 000 A AC-1, 4 poles
LC1F6304



1 600 A AC-1, 4 poles
LC1F7804

Commercial reference coding

> 2, 3, 4 pole contactors for AC-3, AC-1 applications – screw-type terminals

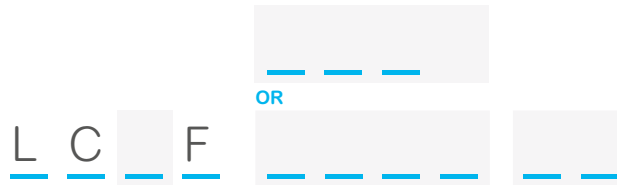

Contactor type

- 1 Single contactor
- 2 Reverser (2 contactor assembly)*
- 3 Star-Delta (3 contactor assembly)

*Coil control voltage does not appear as coils must be ordered separately. See TeSys catalogue MKTED21001_EN – chapter B9.

Rating (A): depends on application

With AC-1 applications

Valid values:	... means:
115	200 A - 3P
1154	200 A - 4P
150	250 A - 3P
1504	250 A - 4P
185	275 A - 3P
1854	275 A - 4P
225	315 A - 3P
2254	315 A - 4P
330	350 A - 3P
3304	350 A - 4P
400	500 A - 3P
4002	500 A - 2P
4004	500 A - 4P
500	700 A - 3P
5002	700 A - 2P
5004	700 A - 4P
630	1000 A - 3P
6302	1000 A - 2P
6304	1000 A - 4P
780	1600 A - 3P
7804	1600 A - 4P
(LCS1F)	1200 A - 3P
1200 (KUE)	
1250	1260 A - 3P
1400	1400 A - 3P
1700	1700 A - 3P
2100	2100 A - 3P
2600	2600 A - 3P

With AC-3 applications

Valid values:	... means:
115	115 A - 3P
150	150 A - 3P
185	185 A - 3P
225	225 A - 3P
265	265 A - 3P
330	330 A - 3P
400	400 A - 3P
500	500 A - 3P
630	630 A - 3P
780	780 A - 3P
800	800 A - 3P
1000	1000 A - 3P

Coil control voltage codes

(no code for reverser assembly product references)

Volts ~	24	48	110	115	120	208	220	230	240	380	400	415	440
LC1F115...F225													
50 Hz (coil LX1)	B5	E5	F5	FE5	-	-	M5	P5	U5	Q5	V5	N	-
60 Hz (coil LX1)	-	E6	F6	-	G6	L6	M6	-	U6	Q6	-	-	R6
40...400 Hz (coil LX9)	-	E7	F7	FE7	G7	L7	M7	P7	U7	Q7	V7	N7	R7
LC1F265...F330													
40...400 Hz (coil LX1)	B7	E7	F7	FE7	G7	L7	M7	P7	U7	Q7	wV7	N7	R7
LC1F400...F630, F1250													
40...400 Hz (coil LX1)	-	E7	F7	FE7	G7 ⁽¹⁾	L7	M7	P7	U7	Q7	V7	N7	R7
LC1F780													
40...400 Hz (coil LX1)	-	-	F7	FE7	F7	L7	M7	P7	U7	Q7	V7	N7	R7
LC1F800													
40...400 Hz (coil LX4) ⁽²⁾	-	-	FW	FW	FW	-	MW	MW	MW	QW	QW	QW	-
LC1F1000, F1400, F1700, F2100, F2600													
40...400 Hz (coil LX1F)	-	-	F7	-	G7	-	M7	P7	U7	Q7	V7	N7	R7

Volts ---	24	48	110	115	220	230	250	400	440
LC1F115...F330									
(coil LX4 F)	BD	ED	FD	GD	MD	MD	UD	-	RD
LC1F400...F330, F1250									
(coil LX4 F)	-	ED	FD	GD	MD	-	UD	-	RD
LC1F780, LC1F1000, F1400, F1700, F2100, F2600									
(coil LX4 F)	-	-	FD	GD	MD	-	UD	-	RD
LC1F800									
(coil LX4 F)	-	-	FW	FW	MW	MW	-	QW	-

(1) F7 for LC1F630
 (2) Coil LX4 F8** + rectifier DR5TE**.

Exemples

LC1F 115 M7

Single contactor • 115 A AC-3 rated current • 220V AC coil • screw-type terminals

LC1F 1250 MD

Single contactor • 1260 A AC-1 rated current • 220V DC coil

LC2F 265

Reverser contactor assembly • 265 A AC-3 rated current (add 2 x LX1FH2202 coils for 230V AC control)



Commercial references

TeSys F contactors offer great performance for large motor starting and resistive loads applications.

- screw-type terminals for lugs or bars
- AC, DC coils, low consumption electronic DC coils for direct control from PLC output.

Check for details, accessories, auxiliaries in TeSys catalogue ref. MKTED210011EN – chapter B9.

2, 3 and 4 NO pole TeSys F contactors



AC3 ⁽¹⁾ rating (A) (up to 440 V)	AC1 rating (A) (≤1000 V)	2 poles	3 poles	4 poles
115	200		LC1F115**	LC1F1154**
150	200		LC1F150**	LC1F1504**
185	275		LC1F185**	LC1F1854**
225	315		LC1F225**	LC1F2254**
265	350		LC1F265**	LC1F2654**
330	400		LC1F330**	LC1F3304**
400	500	LC1F4002*	LC1F400**	LC1F4004**
500	700	LC1F5002**	LC1F500**	LC1F5004**
630	1000	LC1F6302**	LC1F630**	LC1F6304**
780	1600		LC1F780**	LC1F7804**
800	1000		LC1F800**	
1000	1250		LC1F1000**	
	1260		LC1F1250**⁽²⁾	
	1400		LC1F1400**	
	1700		LC1F1700**	
	2100		LC1F2100**	
	2600		LC1F2600**	

Coil voltage: replace 2 dots at end of commercial references by voltage code (P7 = 230 V 50-60 Hz; other codes, see page 61)

(1) AC3 rating is defined for 3P contactors only

(2) ≤ 690 V.

Connection accessories

Terminal adaptors

For contactors:
LC1F115, 150, 185



Insulated terminal blocks Lot of 2
LA9F103

Tightening: with hex key
(through front round hole)

Acceptable conductors.

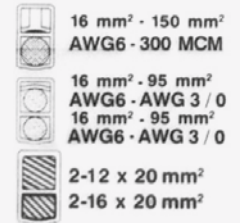
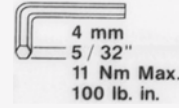

For contactors:
LC1F115
LC1F150, 185
LC1F225, 265,
330, 400, 500
LC1F630, 800



Power terminal protection Lot of 6
shrouds
LA9F701
LA9F702
LA9F703
LA9F704

Prevent from contact with live terminals.

LA9F701	> LC1F115
LA9F702	> LC1F150, 185
LA9F703	> LC1F225...500
LA9F704	> LC1F630, 800



Control circuit take-off Lot of 10
DZ3FA3
DZ3GA3
DZ3HA3
DZ3JA3

Ring to be placed under the head of terminal screw.

DZ3FA3: for M6 bolt	> LC1F115
DZ3GA3: for M8 bolt	> LC1F150, 185
DZ3HA3: for M10 bolt	> LC1F225...500
DZ3JA3: for M12 bolt	> LC1F630, 800

For contactors:
LC1F 1400 to 2600



Phase separators Lot of 4
LA9F801

Reinforce insulation between terminals.

Connection accessories

Terminal adaptors

For contactors:
 LC1F115
 LC1F150, 185
 LC1F225, 265,
 330, 400
 LC1F500
 LC1F630, 800

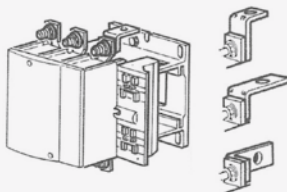
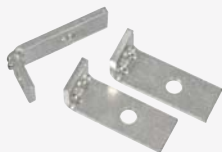

Right angle, 2 holes
 connection adaptor
 (set of 3)

- LA9FF981
- LA9FG981
- LA9FJ981
- LA9FK981
- LA9FL981

For use when cables
 come from rear of
 contactor terminals

- 15 mm width
- 20 mm width
- 25 mm width
- 30 mm width
- 40 mm width

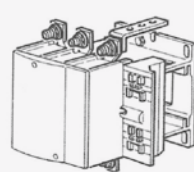

Large surface 4 holes
 connection adaptor
 (set of 3)

- LA9FF979
- LA9FG979
- LA9FJ979
- LA9FK979
- LA9FL979

For use when cables
 come from side of
 contactor terminals

- 15 mm width
- 20 mm width
- 25 mm width
- 30 mm width
- 40 mm width

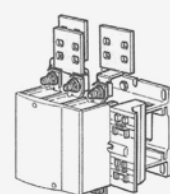

Large surface 5 holes
 connection adaptor
 (set of 3)

- LA9FF980
- LA9FG980
- LA9FJ980
- LA9FK980
- LA9FL980

For use when cables
 come from top of
 contactor terminals

- 15 mm width
- 20 mm width
- 25 mm width
- 30 mm width
- 40 mm width



Set of
 connection
 links
 (set of 3)

- LA7F401
- LA7F402
- LA7F407
- LA7F403
- LA7F404
- LA7F405
- LA7F406

For connection of a
 LC1F contactor to LR9F overload
 thermal relay **LA7F... compatibility**

- 401: LC1F115
with LR9F5.57, 63, 67, 69, F69, F71
- 402: LC1F150, 185
with LR9F5.57, 63
- 407: LC1F185
with LR9F5.71, LR9F71
- 403: LC1F225, 265
with LR9F5.71, LR9F71
- 404: LC1F225...400
with LR9F7.75, 79, LR9F75, F79
- 404: LC1F400
with LR9F7.81, LR9F81
- 405: LC1F500
with LR9F7.75, 79, 81, LR9F75, 79, 81
- 406: LC1F630, 800
with LR9F7.81, LR9F81

For contactors:
 LC1F1250
 LC1F1000, 1400,
 1700, 2100, 2600



LA9F1250
 (6 pieces)



LA9F2100
 (6 pieces)

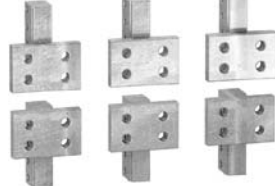

LA9F2600

Right-angled,
 connection adaptor
 (set of 6)

- LA9F1250
- LA9F2100
- LA9F2600

LA9F1250 - 60 mm width for
 LC1F1250

LA9F2100 - 60 mm width for
 LC1F1000, 1400,
 1700, 2100

LA9F2600 - 100 mm width for
 LC1F2600

Connection accessories

Pole interconnections links for 3P contactors

For contactors:
LC1F115... 800

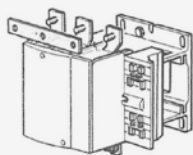

Short circuit link

For use in Star-Delta application
(1 needed)

- LA9FF601
- LA9FG601
- LA9FH601
- LA9FK601
- LA9FL601

- 15 mm width for LC1F115
- 20 mm width for LC1F150, 185
- 25 mm width for LC1F 225...400
- 30 mm width for LC1F500
- 40 mm width for LC1F630, 800

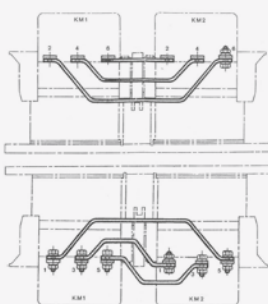

Parallel + reversing
link kit

For use in motor reverser starter
application

- LA9FF976
- LA9F15076
- LA9FG976
- LA9F22576
- LA9FH976
- LA9FJ976
- LA9FK976
- LA9FL976

- for > LC1F115
- > LC1F150
- > LC1F185
- > LC1F225
- > LC1F265
- > LC1F330, 400
- > LC1F500
- > LC1F630, 800

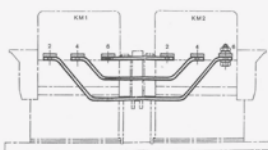

Reversing links

For use in motor reverser starter
application

- LA9FF982
- LA9F15082
- LA9FG982
- LA9F22582
- LA9FH982
- LA9FJ982
- LA9FK982
- LA9FL982

- for > LC1F115
- > LC1F150
- > LC1F185
- > LC1F225
- > LC1F265
- > LC1F330, 400
- > LC1F500
- > LC1F630, 800

Dimensions

Short circuit link

Links for "star" connection of 3 poles - LA9 F•601

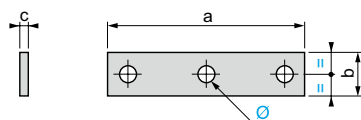

LA9	FF601	FG601	FH601	FK601	FL601
a	69	100	121	140	200
b	15	20	20	30	40
c	3	3	5	5	8
Ø	6.5 x 8.5	8.5 x 10.5	10.5 x 13	11	13

Parallel / reversing bars

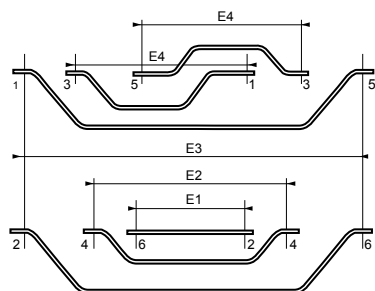

	LA9FF976	LA9F15076	LA9FG976	LA9F22576	LA9FH976	LA9FJ976	LA9FK976	LA9FL976
Bars' thickness (mm)	3	3	3	4	4	5	6	8
E1	77	71	78	62	100	107	112	137
E2	151	151	158	158	196	203	222	297
E3	225	231	238	254	292	299	332	457
E4	114	111	118	110	148	155	167	217
Overall height	6-2	3	3	4	4	5	6	8
	4-4	44	44	44	49	50.5	48	57
	2-6	61	61	61	69	70	70	78.5
	5-3	33	33	38	39	39	42	56
	3-1	33	33	38	39	39	42	56
	1-5	61	61	61	69	70	70	78.5

Connection accessories

Terminal adaptors for 3P contactors

For contactors:
LC1F4002, 5002,
6302



Power terminal protection
shrouds (Set of 6)
LA9F703
LA9F704

Prevent from contact with lives terminals
LA9F703 > for LC1F4002, 5002
LA9F704 > for LC1F6302

Interconnection pole links for 4P contactors

For contactors:
LC1F1154... 6304

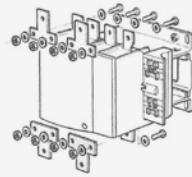

Parallel pole link
(set of 4)

LA9FF602
LA9FG602
LA9FH602
LA9FK602
LA9FL602

For connecting a pair of poles
in parallel on a single contactor

for > LC1F1154
> LC1F1504, 1854
> LC1F2254, 2654, 3304, 4004
> LC1F5004
> LC1F6304



Parallel links
(set of 4)

LA9FF976
LA9F15076
LA9FG976
LA9F22576
LA9FH976
LA9FJ976
LA9FK976
LA9FL976

For use in changeover app.
(4P contactors -downstream
parallel connection of poles)

for > LC1F1154
> LC1F1504
> LC1F1854
> LC1F2254
> LC1F2654
> LC1F3304, 4004
> LC1F5004
> LC1F6304



Power terminal protection
shroud (set of 8)

LA9F706
LA9F707
LA9F708
LA9F709

For use in motor reverser
starter application

for > LC1F1154
> LC1F1504, 1854
> LC1F2254, 2654,
3304, 4004, 5004
> LC1F6304

Dimensions

Parallel connection of poles

Paralleling links (lot of 4)

LA9 FF602, FG602,
FH602

LA9 FK602, FL602

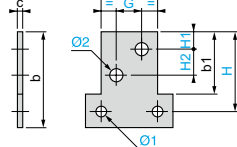
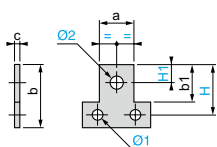

LA9	FF602	FG602	FH602	FK602	FL602
a	25	30	40	50	60
b	45	55	60	85	100
b1	30	35	40	55	65
c	4	5	8	10	10
G	-	-	-	22	26
H	37.5	45	52.5	70	85
H1	12.5	15	15	14	17
H2	-	-	-	22	26
Ø1	6.5	9	11	11	13
Ø2	11	11	13	11	14

Parallel links

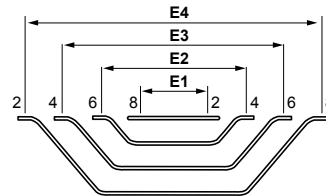

	LA9FF977	LA9F15077	LA9FG977	LA9F22577	LA9FH977	LA9FJ977	LA9FK977	LA9FL977
Bars' thickness (mm)	3	3	3	4	4	5	6	8
Width								
E1	77	71	78	54	100	107	112	137
E2	151	151	158	150	196	203	222	297
E3	225	231	238	246	292	299	332	457
E4	299	311	318	342	388	395	442	617
Overall height								
4-8	3	3	3	4	4	5	6	8
3-7	44	44	44	49	50.5	48	49	57
2-6	61	61	61	69	70	67	70	78.5
1-5	78	78	78	89	91	87	91	105

Mechanical interlocking accessories

Mechanical interlocks for a pair of 3-4P contactors - horizontally mounted

For contactors:
LC1F115 ... LC1F800

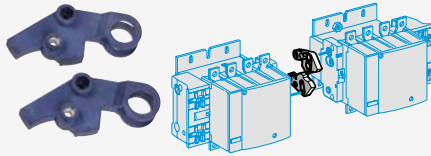

Set of 2 mechanical horizontal interlocks.

Fixing screws enclosed.
Top to tail mounting
See contactors allocation table below.

- LA9FF970**
- LA9FG970**
- LA9FJ970**
- LA9FL970**

Quick interlocking finder

	LC1F115 LC1F1154	LC1F150 LC1F1504	LC1F185 LC1F1854	LC1F225 LC1F2254	LC1F265 LC1F2654	LC1F330 LC1F3304	LC1F400 LC1F4004	LC1F500 LC1F5004	LC1F630 LC1F6304	LC1F780 LC1F7804	LC1F800
LC1F115 LC1F1154	LA9FF970	LA9FF970	-	-	-	-	-	-	-	-	-
LC1F150 LC1F1504	LA9FF970	LA9FF970	-	-	-	-	-	-	-	-	-
LC1F185 LC1F1854	-	-	LA9FG970	LA9FG970	-	-	-	-	-	-	-
LC1F225 LC1F2254	-	-	LA9FG970	LA9FG970	-	-	-	-	-	-	-
LC1F265 LC1F2654	-	-	-	-	LA9FJ970	LA9FJ970	-	-	-	-	-
LC1F330 LC1F3304	-	-	-	-	LA9FJ970	LA9FJ970	-	-	-	-	-
LC1F400 LC1F4004	-	-	-	-	-	-	LA9FJ970	-	-	-	-
LC1F500 LC1F5004	-	-	-	-	-	-	-	LA9FJ970	-	-	-
LC1F630 LC1F6304	-	-	-	-	-	-	-	-	LA9FL970	-	LA9FL970
LC1F780 LC1F7804	-	-	-	-	-	-	-	-	-	-	-
LC1F800	-	-	-	-	-	-	-	-	LA9FL970	-	LA9FL970

Mechanical interlocking accessories

Mechanical interlocks for a pair of 3-4P contactors - vertically mounted (biggest on top)

For contactors:
LC1F115 to
LC1F2254
with
LC1F115 to
LC1F2254

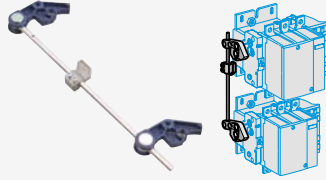

Mechanical horizontal interlocks.

LA9FF4F
LA9FG4F
LA9FG4G

Fixing screws enclosed.
Top to tail mounting
See contactors allocation table below.

For contactors:
LC1F115 to
LC1F2254
with
LC1F265 to
LC1F630
or with LC1F800

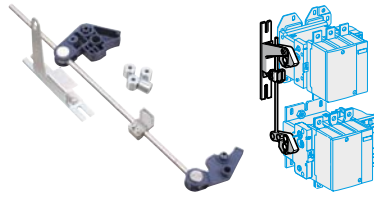

LA9FH4F
LA9FH4G
LA9FJ4F
LA9FJ4G
LA9FK4F
LA9FK4G
LA9FL4F
LA9FL4G

1 square angled mechanical mounting included, for contactor with rating from 265 to 800, except 780.

For contactors:
LC1F265 to
LC1F630
With LC1F265 to
LC1F630 or
with LC1F800



LA9FH4H
LA9FJ4H
LA9FJ4J
LA9FK4H
LA9FK4J
LA9FK4K
LA9FL4H
LA9FL4J
LA9FL4K
LA9FL4L

2 square angled mechanical mountings included.

For contactors:
LC1F780, 7804
with
LC1F780, 7804

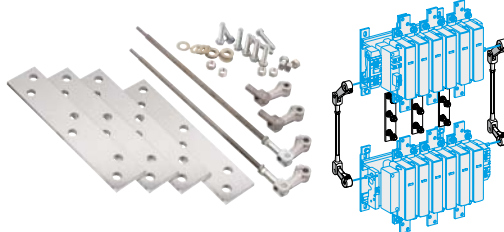

LA9FX970

Quick interlocking finder

	LC1F115 LC1F1154	LC1F150 LC1F1504	LC1F185 LC1F1854	LC1F225 LC1F2254	LC1F265 LC1F2654	LC1F330 LC1F3304	LC1F400 LC1F4004	LC1F500 LC1F5004	LC1F630 LC1F630	LC1F780 LC1F7804	LC1F800
LC1F115 LC1F1154	LA9FF4F	LA9FF4F	LA9FG4F*	LA9FG4F*	LA9FH4F*	LA9FH4F*	LA9FJ4F*	LA9FK4F*	LA9FL4F*	-	LA9FL4F*
LC1F150 LC1F1504	LA9FF4F	LA9FF4F	LA9FG4F*	LA9FG4F*	LA9FH4F*	LA9FH4F*	LA9FJ4F*	LA9FK4F*	LA9FL4F*	-	LA9FL4F*
LC1F185 LC1F1854	LA9FG4F*	LA9FG4F*	LA9FG4G	LA9FG4G	LA9FH4G*	LA9FH4G*	LA9FJ4G*	LA9FK4G*	LA9FL4G*	-	LA9FL4G*
LC1F225 LC1F2254	LA9FG4F*	LA9FG4F*	LA9FG4G	LA9FG4G	LA9FH4G*	LA9FH4G*	LA9FJ4G*	LA9FK4G*	LA9FL4G*	-	LA9FL4G*
LC1F265 LC1F2654	LA9FH4F*	LA9FH4F*	LA9FH4G*	LA9FH4G*	LA9FH4H	LA9FH4H	LA9FJ4H*	LA9FK4H*	LA9FL4H*	-	LA9FL4H*
LC1F330 LC1F3304	LA9FH4F*	LA9FH4F*	LA9FH4G*	LA9FH4G*	LA9FH4H	LA9FH4H	LA9FJ4H*	LA9FK4H*	LA9FL4H*	-	LA9FL4H*
LC1F400 LC1F4004	LA9FJ4F*	LA9FJ4F*	LA9FJ4G*	LA9FJ4G*	LA9FJ4H*	LA9FJ4H*	LA9FJ4J	LA9FK4J	LA9FL4J*	-	LA9FL4J*
LC1F500 LC1F5004	LA9FK4F*	LA9FK4F*	LA9FK4G*	LA9FK4G*	LA9FK4H*	LA9FK4H*	LA9FK4J*	LA9FK4K	LA9FL4K*	-	LA9FL4K*
LC1F630 LC1F630	LA9FL4F*	LA9FL4F*	LA9FL4G*	LA9FL4G*	LA9FL4H*	LA9FL4H*	LA9FL4J*	LA9FL4K*	LA9FL4L	-	LA9FL4L
LC1F780 LC1F7804	-	-	-	-	-	-	-	-	-	LA9FX970 (3P) LA9FX971 (4P)	-
LC1F800	LA9FL4F*	LA9FL4F*	LA9FL4G*	LA9FL4G*	LA9FL4H*	LA9FL4H*	LA9FL4J*	LA9FL4K*	LA9FL4L	-	LA9FL4L

* Biggest on top.

Mechanical interlocking accessories

Mechanical interlocks for 3 x 3-4P contactors - vertically mounted (biggest on top)

For contactors:
LC1F415 to
LC1F5005
with LC1F115 to
LC1F5004 and
with LC1F115 to
LC1F5004



Vertical interlocking kit
for 3 contactors

**LA9FF4F4F to
LA9FK4K4K**

See reference coding
principle below.

1 square angled mechanical
mounting included per driven
contactor LC1F265 to 5004.

For contactors:
LC1F630 to
LC1F8004
with LC1F630 to
LC1F8004
and with LC1F630
to LC1F8004



Vertical interlocking kit
for 3 contactors

**LA9FL4F4F to
LA9FL4L4L**

See reference coding
principle below.

1 square angled mechanical
mounting included per driven
contactor LC1F265 to 8004.

Interlocking kit: reference coding principle

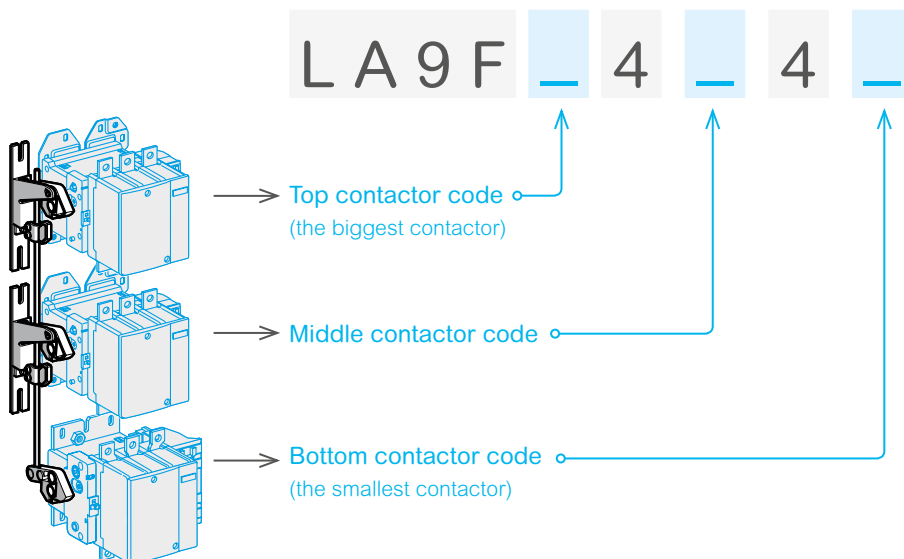

Code	Contactor
F	LC1F115 - LC1F1154
	LC1F150 - LC1F1504
G	LC1F185 - LC1F1854
	LC1F225 - LC1F2254
H	LC1F265 - LC1F2654
	LC1F330 - LC1F3304
J	LC1F400 - LC1F4004
K	LC1F500 - LC1F5004
L	LC1F630 - LC1F6304
	LC1F800 - LC1F8004

Example

Top:	LC1F630	} Corresponding kit: LA9FL4H4F
Middle:	LC1F330	
Bottom:	LC1F115	

Products reference index

Cat. no.	Pages	Cat. no.	Pages	Cat. no.	Pages	Cat. no.	Pages	Cat. no.	Pages
D		LA9D80962	50	LA9FG610	31	LA9FL600	31	LADT9R1	36, 55
DZ3FA3	61	LA9D80963	52	LA9FG970	18, 31, 39, 66	LA9FL601	64	LADT9R1V	36, 55
DZ3GA3	61	LA9D80973	29	LA9FG976	18, 64, 65	LA9FL602	65	LC1	
DZ3HA3	61	LA9D80978	12, 53	LA9FG977	39	LA9FL970	18, 39, 66	LC1D09	27, 28
DZ3JA3	61	LA9D115503	49	LA9FG979	62	LA9FL976	18, 64, 65	LC1D09**	12, 21, 48
G		LA9D115504	52	LA9FG980	62	LA9FL977	39	LC1D12	27, 28
GV7AC03	49	LA9D115603	49	LA9FG981	62	LA9FL979	62	LC1D12**	12, 21, 48
LA7		LA9D115604	52	LA9FG982	39, 64	LA9FL980	62	LC1D18	27, 28
LA7F401	62	LA9D115703	49	LA9FH4F	67	LA9FL981	62	LC1D18**	12, 21, 48
LA7F402	62	LA9D115704	52	LA9FH4G	67	LA9FL982	39, 64	LC1D25	28
LA7F403	62	LA9DR3S	55	LA9FH4H	67	LA9FX970	67	LC1D25**	12, 21, 48
LA7F404	62	LA9E1	45	LA9FH600	31	LA9K105I	45	LC1D32	27, 28
LA7F405	62	LA9E2	45	LA9FH601	64	LA9K105S	45	LC1D32**	12, 48
LA7F406	62	LA9F103	61	LA9FH602	65	LA9K0969	45	LC1D38	28
LA7F407	62	LA9F701	61	LA9FH610	31	LAD		LC1D38**	12, 48
LA9		LA9F702	61	LA9FH976	18, 64, 65	LAD4BB3	49	LC1D40A	28
LA9D65A6	29, 51	LA9F703	61, 65	LA9FH977	39	LAD4CM	14, 16, 29, 36, 37, 56	LC1D40A**	12, 38, 48
LA9D65A9	29, 51	LA9F704	61, 65	LA9FH982	39, 64	LAD9P3	29, 50	LC1D40A3**	16, 48
LA9D1260	52	LA9F706	65	LA9FJ4F	67	LAD9P32	50	LC1D40A6**	14, 48
LA9D1261	49, 52	LA9F707	65	LA9FJ4G	67	LAD9P33	50	LC1D50	27
LA9D1262	50	LA9F708	65	LA9FJ4H	67	LAD9PVG	21, 54	LC1D50A	28
LA9D1263	52	LA9F709	65	LA9FJ4J	67	LAD9R1	12, 53	LC1D50A**	12, 38, 48
LA9D2560	52	LA9F801	61	LA9FJ600	31	LAD9R1V	12, 53	LC1D50A3**	16, 48
LA9D2561	52	LA9F1250	62	LA9FJ610	31	LAD9R3	12, 53	LC1D50A6**	14, 48
LA9D2563	52	LA9F2100	62	LA9FJ970	18, 31, 39, 66	LAD9R3S	38	LC1D65A	28
LA9D3260	49	LA9F2600	62	LA9FJ976	18, 64, 65	LAD9SD3	28, 29, 54	LC1D65A**	12, 38, 48
LA9D4002	12, 14, 36, 37, 38, 53	LA9F15000	31	LA9FJ977	39	LAD9SD3S	29, 50	LC1D65A3**	16, 48
LA9D5017	29	LA9F15076	18, 64, 65	LA9FJ979	62	LAD9V1	29, 53, 55	LC1D65A6**	14, 48
LA9D5018	29	LA9F15077	39	LA9FJ980	62	LAD9V2	14, 16, 17, 29, 56	LC1D80	27, 28, 31
LA9D8002	12, 36, 37, 38, 53	LA9F15082	39, 64	LA9FJ981	62	LAD9V5	29, 51	LC1D80**	12, 38, 48
LA9D8017	28, 29, 54	LA9F18517	31	LA9FJ982	39, 64	LAD9V6	29, 51	LC1D093**	16, 48
LA9D8018	28, 29, 54	LA9F22500	31	LA9FJ988	67	LAD9V10	16, 51	LC1D95	28
LA9D8067	49, 52	LA9F22510	31	LA9FK4F	67	LAD9V11	16, 51	LC1D95**	12, 38, 48
LA9D8069	12, 29, 53	LA9F22576	18, 64, 65	LA9FK4G	67	LAD9V12	16, 51	LC1D096**	14, 48
LA9D8070	36	LA9F22577	39	LA9FK4H	67	LAD9V13	16, 51	LC1D098**	21, 48
LA9D11502	12, 14, 28, 29, 36, 37, 38, 53	LA9F22582	39, 64	LA9FK4J	67	LAD9V14	54	LC1D099**	48
LA9D11517	28, 29, 55	LA9FF4F	67	LA9FK4K	67	LAD9V16	29, 56	LC1D115	27, 28
LA9D11567	49, 52	LA9FF4F4F	68	LA9FK4K4K	68	LAD9V17	29, 56	LC1D115**	12, 38, 48
LA9D11569	12, 53	LA9FF600	31	LA9FK600	31	LAD9VP1	14	LC1D123**	16, 48
LA9D11570	36	LA9FF601	64	LA9FK601	64	LAD9VP2	14	LC1D126**	14, 48
LA9D11571	38, 55	LA9FF602	65	LA9FK602	65	LAD9VP3	14	LC1D128**	21, 48
LA9D12974	29	LA9FF610	31	LA9FK976	18, 64, 65	LAD9VP4	14	LC1D129**	48
LA9D15017	28, 29, 55	LA9FF970	18, 31, 39, 66	LA9FK977	39	LAD912GV	28, 54	LC1D150	27, 28
LA9D32974	29	LA9FF976	18, 64, 65	LA9FK979	62	LAD8002	14	LC1D150**	12, 38, 48
LA9D40961	50, 52	LA9FF977	39	LA9FK980	62	LAD91217	28, 29, 54	LC1D183**	16, 48
LA9D40963	52	LA9FF979	62	LA9FK981	62	LAD91218	28, 29, 54	LC1D186**	14, 48
LA9D40973	29	LA9FF980	62	LA9FK982	39, 64	LAD93217	28, 29, 54	LC1D188**	21, 48
LA9D50978	12, 29, 53	LA9FF981	62	LA9FL4F	67	LAD93218	28, 29, 54	LC1D253**	16, 48
LA9D80691	38, 55	LA9FF982	39, 64	LA9FL4F4F	68	LAD96560	49	LC1D256**	14, 48
LA9D80961	50, 52	LA9FG4F	67	LA9FL4G	67	LAD96570	49	LC1D258**	21, 48
		LA9FG4G	67	LA9FL4H	67	LAD96580	52	LC1D323**	16, 48
		LA9FG600	31	LA9FL4J	67	LADS2	29	LC1D326**	14, 48
		LA9FG601	64	LA9FL4K	67	LADT3R1	37	LC1D383	48
		LA9FG602	65	LA9FL4L	67			LC1D386**	14, 48
				LA9FL4L4L	68				

Find all our connection accessories

Linergy catalog



Ref.: LUYED213001EN



Scan or click on QR code to reach the portal

Control and protection components TeSys catalogue



Ref.: MKTED210011EN



Scan or click on QR code to reach the portal



Schneider Electric Industries SAS

35, rue Joseph Monier
CS 30323
92506 Rueil Malmaison Cedex
France

RCS Nanterre 954 503 439
Capital social 896 313 776 €
www.schneider-electric.com

03-2018
CPTG011_EN

© 2018 - Schneider Electric - All rights reserved.
All trademarks are owned by Schneider Electric Industries SAS or its affiliated companies.

This document has been
printed on recycled paper.

