

FLUKE®

374 FC/375 FC/376 FC

Clamp Meters

Users Manual

September 2015 Rev. 1, 9/19

© 2015-2019 Fluke Corporation. All rights reserved. Specifications are subject to change without notice.

All product names are trademarks of their respective companies.

LIMITED WARRANTY AND LIMITATION OF LIABILITY

This Fluke product will be free from defects in material and workmanship for three years from the date of purchase. This warranty does not cover fuses, disposable batteries, or damage from accident, neglect, misuse, alteration, contamination, or abnormal conditions of operation or handling. Resellers are not authorized to extend any other warranty on Fluke's behalf. To obtain service during the warranty period, contact your nearest Fluke authorized service center to obtain return authorization information, then send the product to that Service Center with a description of the problem.

THIS WARRANTY IS YOUR ONLY REMEDY. NO OTHER WARRANTIES, SUCH AS FITNESS FOR A PARTICULAR PURPOSE, ARE EXPRESSED OR IMPLIED. FLUKE IS NOT LIABLE FOR ANY SPECIAL, INDIRECT, INCIDENTAL OR CONSEQUENTIAL DAMAGES OR LOSSES, ARISING FROM ANY CAUSE OR THEORY. Since some states or countries do not allow the exclusion or limitation of an implied warranty or of incidental or consequential damages, this limitation of liability may not apply to you.

Fluke Corporation
P.O. Box 9090
Everett, WA 98206-9090
U.S.A.

Fluke Europe B.V.
P.O. Box 1186
5602 BD Eindhoven
The Netherlands

ООО «Флюк СИИЙЭС»
125167, г. Москва,
Ленинградский проспект дом 37,
корпус 9, подъезд 4, 1 этаж

Table of Contents

Title	Page
Introduction.....	1
Contact Fluke	2
Safety Information	3
Replacement Part List.....	9
The Product.....	10
Specifications	22

Introduction

The Fluke 374 FC/375 FC/376 FC (the Product) measures true-rms ac current and voltage, dc current and voltage, inrush current, resistance, and capacitance. The 375 FC and 376 FC also measure frequency and dc millivolts. The detachable iFlex (Flexible Current Probe) that is included with the 376 FC (optional with the 374 FC and 375 FC) expands the measurement range to 2500 A ac. The Flexible Current Probe provides increased display flexibility and allows measurements of awkward sized conductors and improved wire access. The illustrations in this manual show the 376 FC.

Contact Fluke

To contact Fluke, call one of the following telephone numbers:

- Technical Support USA: 1-800-44-FLUKE (1-800-443-5853)
- Calibration/Repair USA: 1-888-99-FLUKE (1-888-993-5853)
- Canada: 1-800-36-FLUKE (1-800-363-5853)
- Europe: +31 402-675-200
- Japan: +81-3-6714-3114
- Singapore: +65-6799-5566
- China: +86-400-921-0835
- Brazil: +55-11-3530-8901
- Anywhere in the world: +1-425-446-5500

Or, visit Fluke's website at www.fluke.com.

To register your product, visit <http://register.fluke.com>.

To see, print, or download the latest manual supplement, visit <http://us.fluke.com/user/support/manuals>.

Safety Information

A **Warning** identifies conditions and procedures that are dangerous to the user. A **Caution** identifies conditions and procedures that can cause damage to the Product or the equipment under test.

Symbols used on the Product and in this manual are explained in Table 1.



To prevent possible electrical shock, fire, or personal injury:

- **Carefully read all instructions.**
- **Read all safety information before you use the Product.**
- **Use the Product only as specified, or the protection supplied by the Product can be compromised.**
- **Do not use the Product around explosive gas, vapor, or in damp or wet environments.**
- **Do not use and disable the Product if it is damaged.**
- **Do not use the Product if it operates incorrectly.**

- **Prior to use, ensure the Product is clean, dry, and in good repair. Do not use the product if has been exposed to water, cleaning solutions, battery electrolyte leakage, or other contaminants that may have entered the enclosure. These contaminants can reduce or eliminate the protection provided by the Product against electric shock or arc explosion. Have the product dried, cleaned, or repaired as necessary to ensure continued safe operation**
- **Use only correct measurement category (CAT), voltage, and amperage rated probes, test leads, and adapters for the measurement.**
- **Do not exceed the Measurement Category (CAT) rating of the lowest rated individual component of a Product, probe, or accessory.**
- **Comply with local and national safety codes. Use personal protective equipment (approved rubber gloves, face protection, and flame-resistant clothes) to prevent shock and arc blast injury where hazardous live conductors are exposed.**
- **Before each use, examine the Product. Look for cracks or missing pieces of the clamp housing or output cable insulation. Also look for loose or weakened components. Carefully examine the insulation around the jaws.**
- **Do not use test leads if they are damaged. Examine the test leads for damaged insulation and measure a known voltage.**
- **Do not touch voltages >30 V ac rms, 42 V ac peak, or 60 V dc.**
- **Do not measure current while the test leads are in the input jacks.**
- **Do not apply more than the rated voltage, between the terminals or between each terminal and earth ground.**

- **De-energize the circuit or wear personal protective equipment in compliance with local requirements before you apply or remove the Flexible Current Probe.**
- **Measure a known voltage first to make sure that the Product operates correctly.**
- **Limit operation to the specified measurement category, voltage, or amperage ratings.**
- **The battery door must be closed and locked before you operate the Product.**
- **Connect the common test lead before the live test lead and remove the live test lead before the common test lead.**
- **Remove all probes, test leads, and accessories before the battery door is opened.**
- **Keep fingers behind the finger guards on the probes.**
- **Hold the Product behind the tactile barrier.**
- **Replace the batteries when the low battery indicator shows to prevent incorrect measurements.**
- **Do not use the HOLD function to measure unknown potentials. When HOLD is turned on, the display does not change when a different potential is measured.**
- **Disconnect power and discharge all high-voltage capacitors before you measure resistance, continuity, capacitance, or a diode junction.**
- **Remove the input signals before you clean the Product.**
- **Use only specified replacement parts.**

- **When batteries are changed, ensure that the calibration seal in the battery compartment is not damaged. If damaged, the Product may not be safe to use. Return the Product to Fluke for replacement of the seal.**
- **Do not use in CAT III or CAT IV environments without the protective cap of test probe. The protective cap decreases the exposed probe metal <4mm. This decreases the possibility of arc flash from short circuits.**
- **Do not place magnet inside Category IV panel. Place it outside the panel instead.**

For safe operation and maintenance of the Product:

- **Repair the Product before use if the battery leaks.**
- **Have an approved technician repair the Product.**

⚠ Caution

To avoid possible damage to the Product or to equipment under test:

- **Use the proper jacks, function, and range for the measurement application.**
- **Clean the case and accessories with a damp cloth and mild detergent only. Do not use abrasives or solvents.**

Note

The Measurement Category (CAT) and voltage rating of any combination of test probe, test probe accessory, current clamp accessory, and the Product is the LOWEST rating of any individual component.

Table 1. Symbols















Symbol	Meaning	Symbol	Meaning
	AC (Alternating Current)		Earth
	DC (Direct Current)		WARNING. HAZARDOUS VOLTAGE. Risk of electric shock.
	Conforms to European Union directives.		WARNING. RISK OF DANGER.
	Consult user documentation.		Battery. Low battery when shown on display.
	Double Insulated		Application around and removal from uninsulated hazardous live conductors is permitted.
	Conforms to relevant Australian EMC standards.		Certified by CSA Group to North American safety standards.
	Do not apply to or remove from HAZARDOUS LIVE conductors. Do not apply around or remove from uninsulated hazardous live conductors without taking additional protective measures.		

Table 2. Symbols (Cont.)

Symbol	Meaning
CAT II	Measurement Category II is applicable to test and measuring circuits connected directly to utilization points (socket outlets and similar points) of the low-voltage MAINS installation.
CAT III	Measurement Category III is applicable to test and measuring circuits connected to the distribution part of the building's low-voltage MAINS installation.
CAT IV	Measurement Category IV is applicable to test and measuring circuits connected at the source of the building's low-voltage MAINS installation.
	This product complies with the WEEE Directive marking requirements. The affixed label indicates that you must not discard this electrical/electronic product in domestic household waste. Product Category: With reference to the equipment types in the WEEE Directive Annex I, this product is classed as category 9 "Monitoring and Control Instrumentation" product. Do not dispose of this product as unsorted municipal waste.

Replacement Part List

Table 3 lists the available replacement parts.

Table 3. Replacement Parts

Item	Qty.	Fluke Part or Model Number
Battery, AA 1.5 V	2	376756
Battery Door Assembly	1	4696918
Test lead set	1	TL75
Flexible current probe i2500-10	1	3676410
Flexible current probe i2500-18	1	3798105
Magnet strap	1	669952
STRAP 9 INCHES	1	669960
Soft Case	1	3752958

The Product

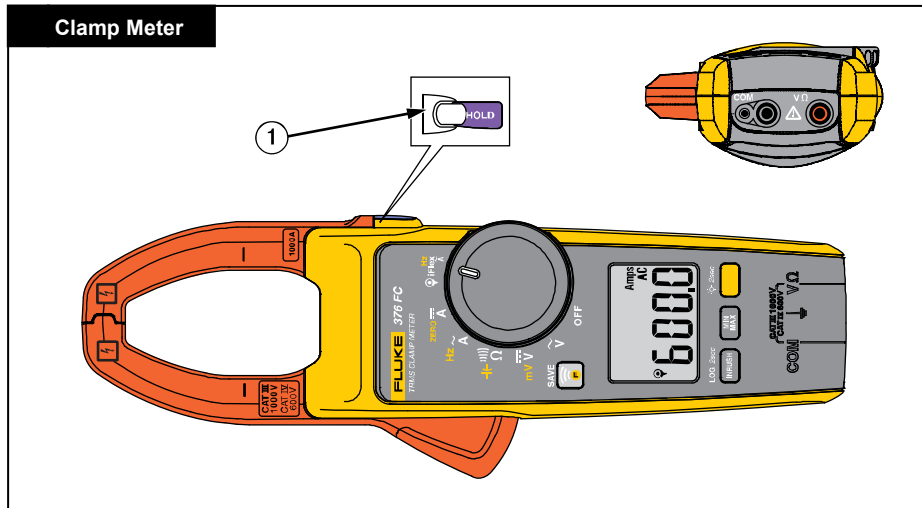
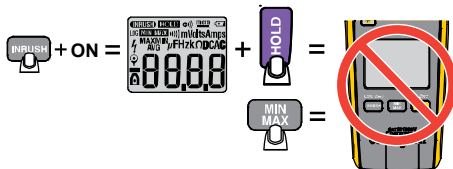
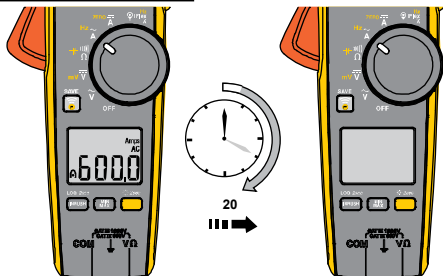

fig01.emf

Auto Power Off



Backlight

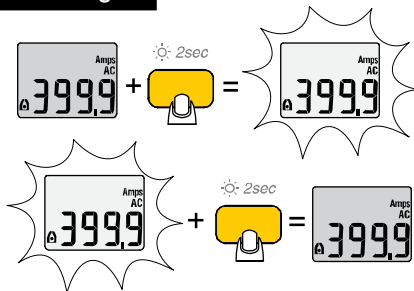

fig02_3.emf

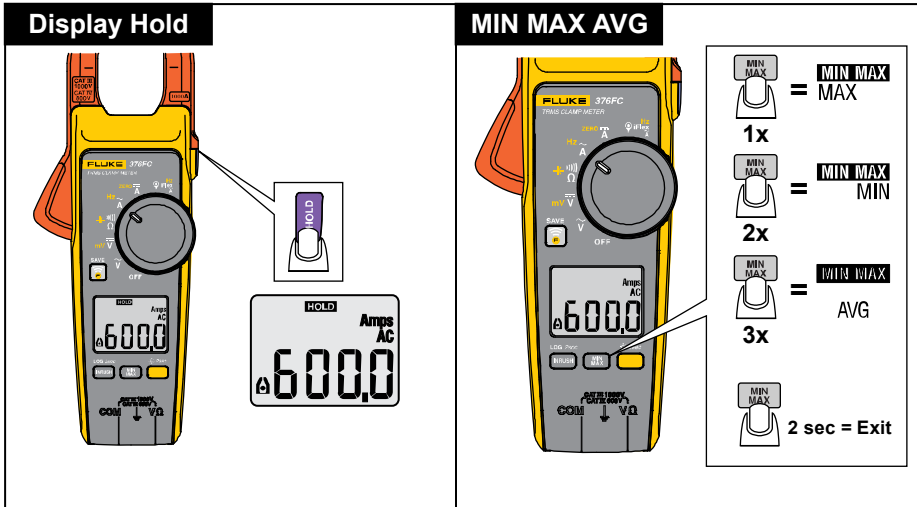

fig04_5.emf

LOG (375 FC and 376 FC)

LOG 2sec



2 sec = LOG

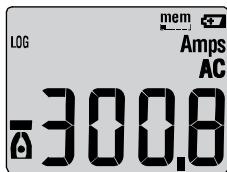

Clear Memory (375 FC and 376 FC)

LOG 2sec



+ ON +

SAVE



x1

SAVE



x2



5 sec



fig_16.emf

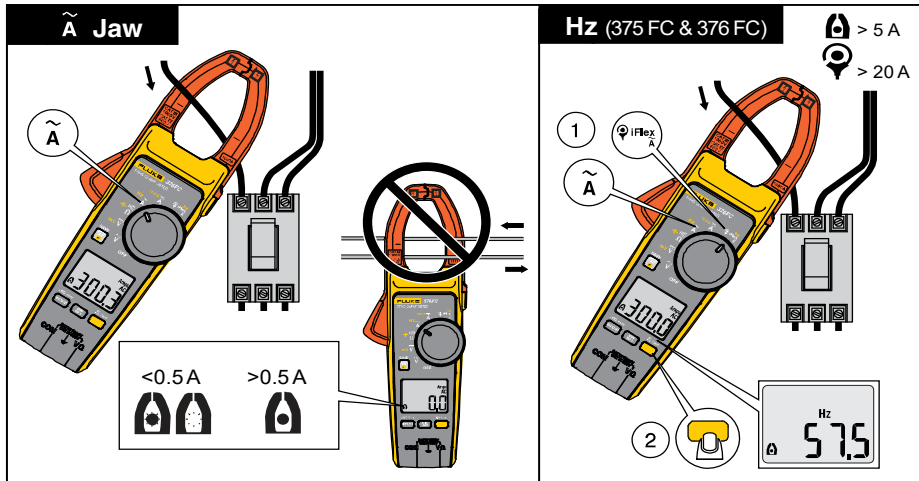

fig07.emf

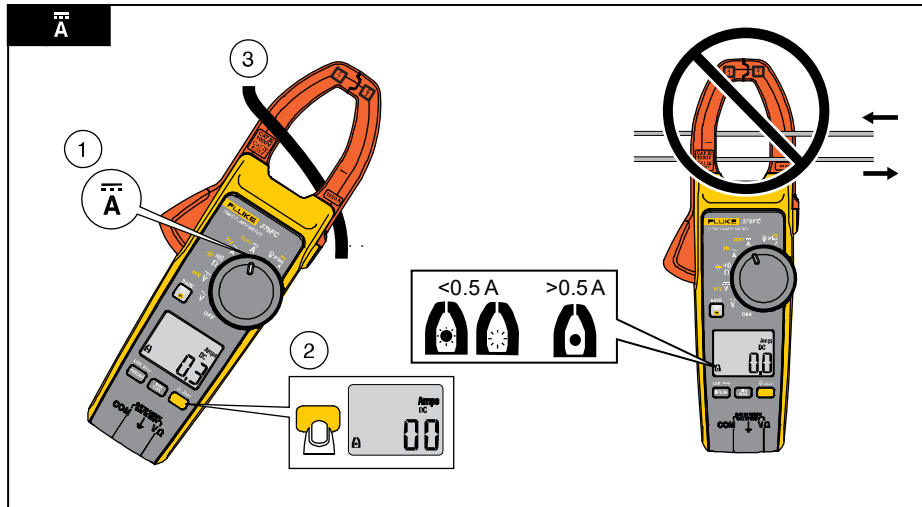

Fig08.emf

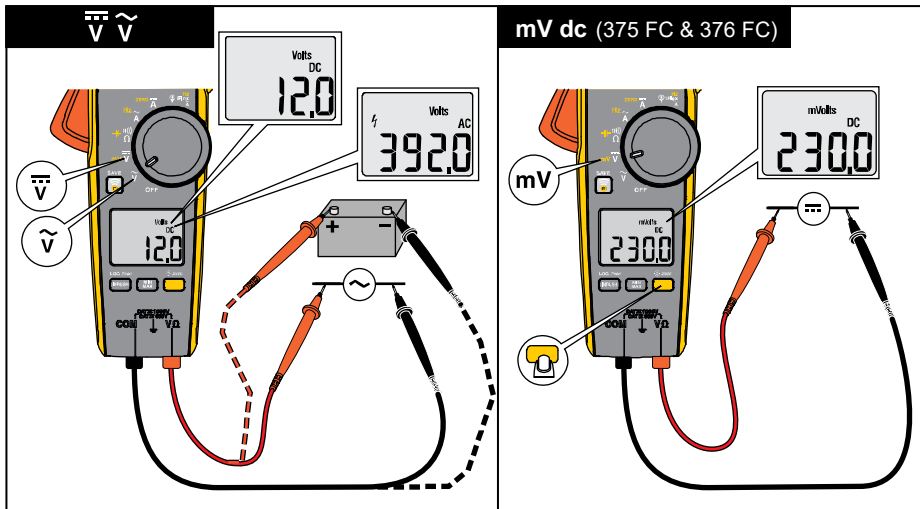

fig09_10.emf

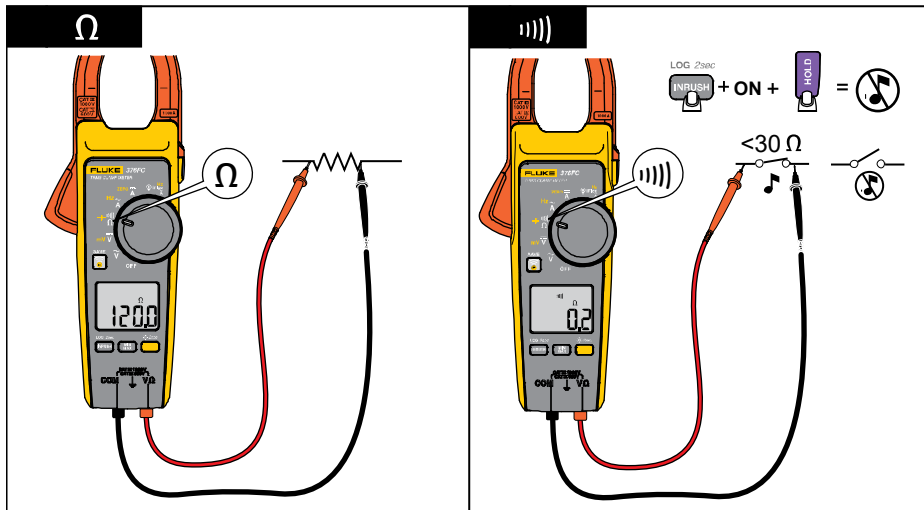

Fig15.emf

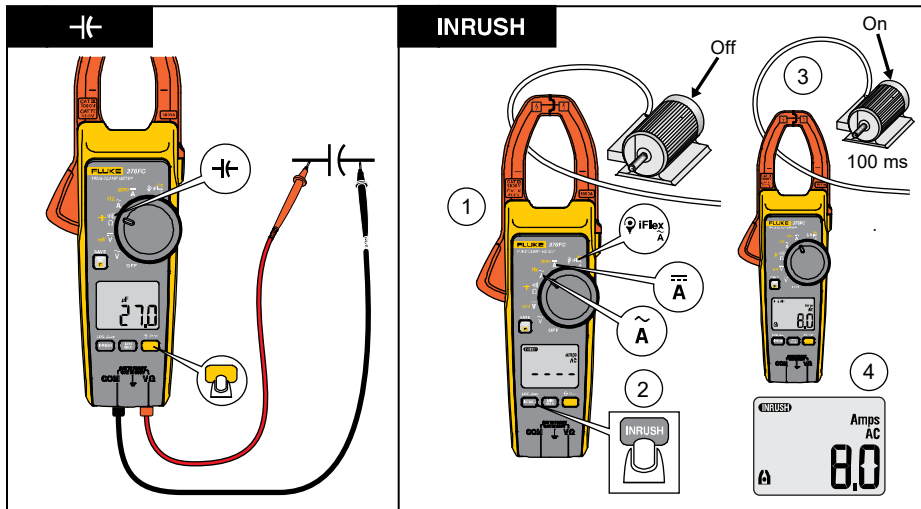

fig13_14.emf

374 FC/375 FC/376 FC

Users Manual

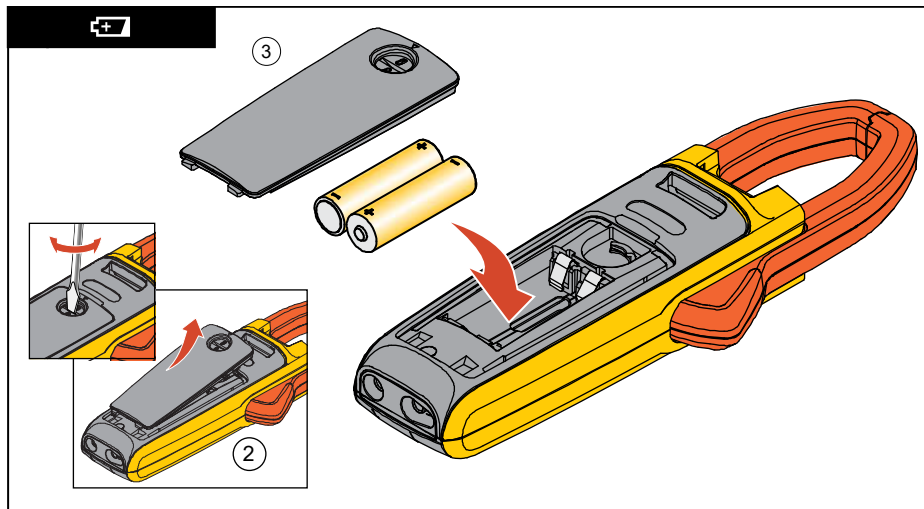
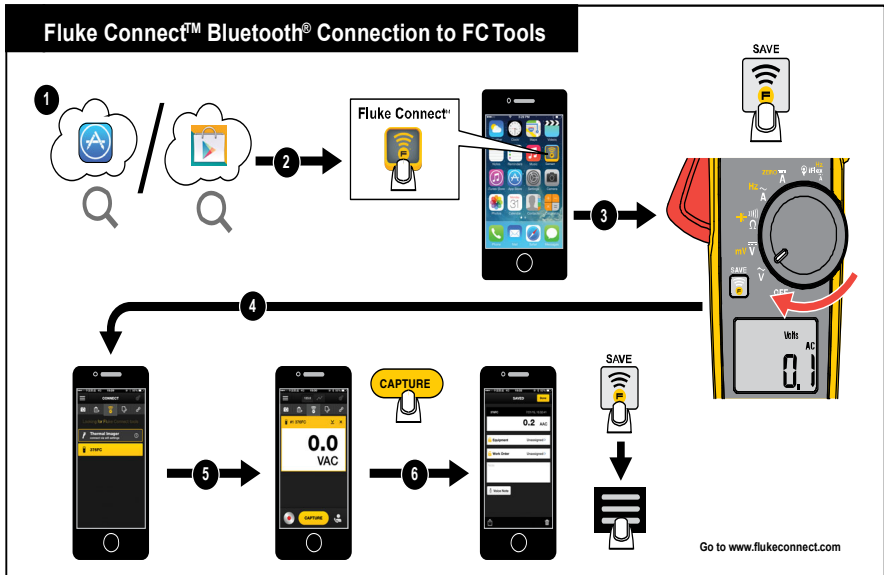

fig11_12.emf



Specifications

Maximum voltage between any Terminal and Earth Ground	1000 V
Batteries.....	2 AA, NEDA 15A, IEC LR6
Operating Temperature.....	-10 °C to +50 °C
Storage Temperature.....	-40 °C to +60 °C
Operating Humidity	Non condensing (< 10°C) ≤90 % RH (at 10 °C to 30 °C) ≤75 % RH (at 30 °C to 40 °C) ≤45 % RH (at 40 °C to 50 °C)
Operating Altitude	2000 m
Storage Altitude	12,000 m
Size (L x W x H)	249 mm x 85 mm x 45 mm
Weight.....	410 g
Jaw Opening.....	34 mm
Flexible Current Probe Diameter	7.5 mm
Flexible Current Probe Cable Length (head to electronics connector)	1.8 m

Safety	IEC 61010-1, Pollution Degree 2 IEC 61010-2-032: CAT III 1000V / CAT IV 600V IEC 61010-2-033: CAT III 1000V / CAT IV 600V
Intrusion Protection (IP) Rating	IEC 60529: IP30
Radio Frequency Certification.....	FCC ID:T68-FBLE IC:6627A-FBLE
Wireless Radio Frequency Range	2412 MHz to 2462 MHz
Output Power	<100 mW

Electromagnetic Compatibility (EMC)

International	IEC 61326-1: Portable, Electromagnetic Environment, IEC 61326-2-2 CISPR 11: Group 1, Class A
---------------	---

Group 1: Equipment has intentionally generated and/or uses conductively-coupled radio frequency energy that is necessary for the internal function of the equipment itself.

Class A: Equipment is suitable for use in all establishments other than domestic and those directly connected to a low-voltage power supply network that supplies buildings used for domestic purposes. There may be potential difficulties in ensuring electromagnetic compatibility in other environments due to conducted and radiated disturbances. Emissions that exceed the levels required by CISPR 11 can occur when the equipment is connected to a test object.

374 FC/375 FC/376 FC

Users Manual

Temperature Coefficients..... Add 0.1 x specified accuracy for each degree C above 28 °C or below 18 °C

AC Current via Jaw

Range

374 FC and 375 FC 600.0 A

376 FC 999.9 A

Resolution 0.1 A

Accuracy 2 % \pm 5 digits (10 Hz to 100 Hz)

2.5 % \pm 5 digits (100-500 Hz)

Crest Factor (50 Hz/60 Hz)

376 FC 3 @ 500 A

2.5 @ 600 A

1.42 @ 1000 A

374 FC and 375 FC 2.5 @ 350 A

1.42 @ 600 A

Note: Add 2 % for C.F. >2

AC Current via Flexible Current Probe

Range	2500 A
Resolution	0.1 A (≤ 999.9 A) 1 A (≤ 2500 A)
Accuracy	3 % ± 5 digits (5 – 500 Hz)
Crest Factor (50 Hz/60 Hz)	3.0 @ 1100 A 2.5 @ 1400 A 1.42 @ 2500 A Add 2 % for C.F. >2

Position Sensitivity

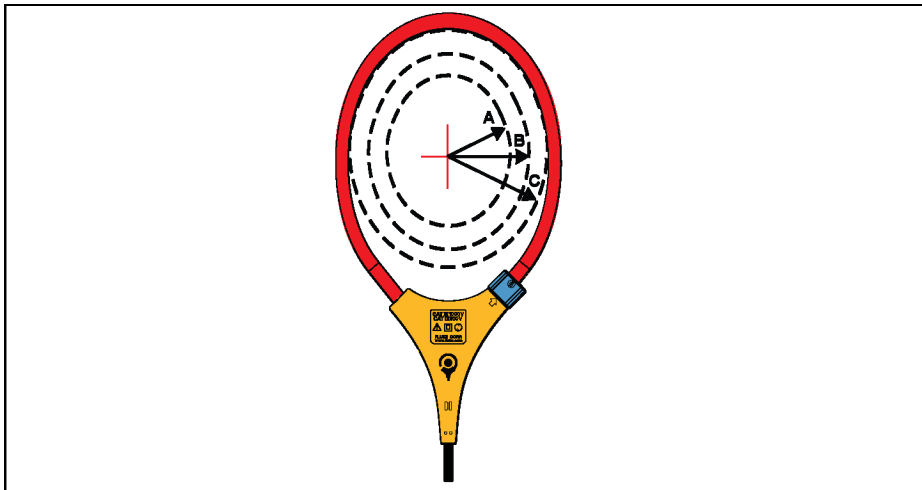

ghn12.png

Figure 1. Position Sensitivity

Distance from Optimum	i2500-10 Flex	i2500-18 Flex	Error
A	0.5 in (12.7 mm)	1.4 in (35.6 mm)	±0.5 %
B	0.8 in (20.3 mm)	2.0 in (50.8 mm)	±1.0 %
C	1.4 in (35.6 mm)	2.5 in (63.5 mm)	±2.0 %
Measurement uncertainty assumes centralized primary conductor at optimum position, no external electrical or magnetic field, and within operating temperature range.			

DC Current

Range

374 FC and 375 FC 600.0 A

376 FC 999.9 A

Resolution 0.1 A

Accuracy 2 % ±5 digits

AC Voltage

Range	1000 V
Resolution	0.1 V (≤ 600.0 V)
	1 V (≤ 1000 V)
Accuracy	1.5 % ± 5 digits (20 Hz to 500 Hz)

DC Voltage

Range	1000 V
Resolution	0.1 V (≤ 600.0 V)
	1 V (≤ 1000 V)
Accuracy	1 % ± 5 digits

mV dc (375 FC and 376 FC)

Range	500.0 mV
Resolution	0.1 mV
Accuracy	1 % ± 5 digits

Frequency via Jaw

Range

375 FC and 376 FC 5.0 Hz to 500.0 Hz

Resolution 0.1 Hz

Accuracy 0.5 % ± 5 digits

Trigger Level 5 Hz to 10 Hz, ≥ 10 A
10 Hz to 100 Hz, ≥ 5 A
100 Hz to 500 Hz, ≥ 10 A

Frequency via Flexible Current Probe

Range

375 FC and 376 FC 5.0 Hz to 500.0 Hz

Resolution 0.1 Hz

Accuracy 0.5 % ± 5 digits

Trigger Level 5 Hz to 20 Hz, ≥ 25 A
20 Hz to 100 Hz, ≥ 20 A
100 Hz to 500 Hz, ≥ 25 A

Resistance

Range

374 FC 6000 Ω 375 FC and 376 FC 60 k Ω

Resolution

374 FC 0.1 Ω ($\leq 600 \Omega$)1 Ω ($\leq 6000 \Omega$)375 FC and 376 FC 0.1 Ω ($\leq 600 \Omega$)1 Ω ($\leq 6000 \Omega$)10 Ω ($\leq 60 \text{ k}\Omega$)Accuracy 1 % ± 5 digits**Capacitance**Range 1000 μF Resolution 0.1 μF ($\leq 100 \mu\text{F}$)1 μF ($\leq 1000 \mu\text{F}$)Accuracy 1 % ± 4 digits