

Product Data Sheet

GWJ3202A

JOINON range



The I-CON wall boxes are the JOINON solution designed and studied for integration into private and semi-public contexts in accordance with the international standard IEC 61851-1 ed. 3. They feature an elegant and compact design, a special "one-hand recharge" function, a vandal-proof socket as an alternative to the cable and holder connector integrated in the station, an IP55 protection rating together with an IK10 impact rating, smart load management, back-lighting and various installation options: wall-mounting, flush-mounting or floor-mounting.

INPUT		- Socket/Connector Nr. (Type)	1 (Type 2 socket, with shutters)
Terminal blocks	3 x 10 mm ²	Charging activation	Free access
Rated current	32 A	Human Interface	LED RGB + slide touch display
Total power	7.4 Kilowatt	Connectivity	BLE
OUTPUT		MECHANICAL FACTS	-
Rated voltage	230 V	Mounting and installation	Wall mounting (floor mounting with support)
Current supplied (max)	32 A	Colour	Dark grey
Maximum current	7.4 Kilowatt	Material	Thermoplastic (Post-industrial origin)
Thermal-magnetic protection	Currently not present	External treatments	No
Type of residual current protection	Currently not present	IP degree	IP55
Power meter	Currently not present	Mechanical resistance	IK10
DC Leakage check	Yes	Operating temperature	-25 +50 °C
(Auto)restart electrical protections	Currently not present	Customizations	No

DIMENSIONAL

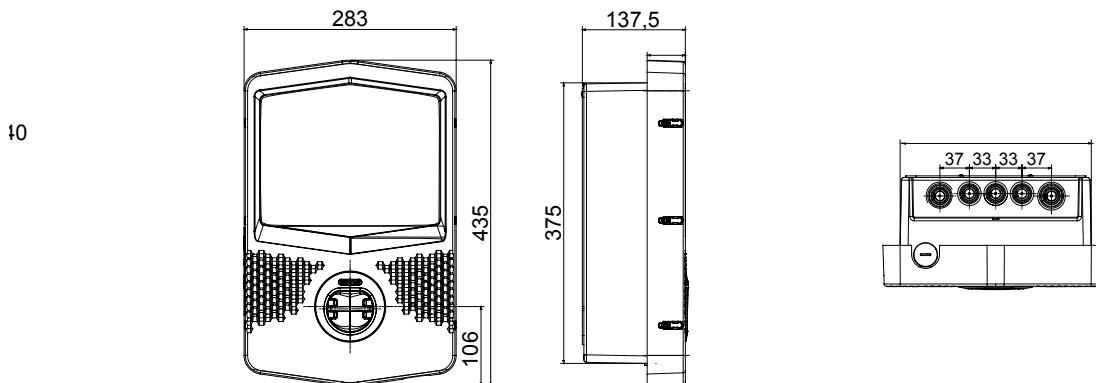

TECHNICAL SYMBOLOGY

IP

IP55

IK

IK10

STANDARDS/APPROVALS



GEWISS S.p.A. Via A. Volta, 1
24069 Cenate Sotto - Bergamo - Italy
tel. +39 035 94 61 11 fax +39 035 94 69 09

www.gewiss.com
sat@gewiss.com
Last update 20/04/2023

Data, measures, designs and pictures are shown only as informative purposes, and could be changed without previous notice