

# INSTRUCTION

Planado  
312621.002



~ 220 - 240 V 50/60 Hz IP 54, IP 50 IK05



 3 x 1,5 mm<sup>2</sup>

 2,50 mm<sup>2</sup>



 Umgebungstemperatur /  
temperature ambiente  
=> -25 °C ... + 35 °C

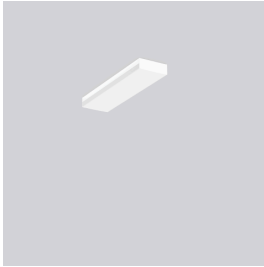

L 600, B 160, H 58



2,2 kg



$\Phi$  [lm]

$P_{\square}$  [W]

$P_{\circ}$

LED

2050

17

2 x 11 W

CCT [K]

CRI

RG  $\square$

EEK 

3000

80

RG 1

E

$I_{max}$    $I_{max}/2$   
T50

 B10  
[St.]

 B16  
[St.]

 C10  
[St.]

 C16  
[St.]

$\cos \varphi$

11,6 A / 220  $\mu$ s

45

72

70

112

0,96

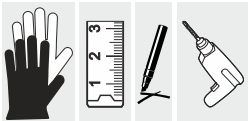



### Allgemeine Sicherheitshinweise

- Der elektrische Anschluss muss ordnungsgemäß nach geltenden Normen und den nationalen sowie internationalen Sicherheits- und Unfallverhütungsvorschriften erfolgen.
- Beschädigte Leuchten dürfen nicht betrieben werden.
- Keine Haftung für Schäden durch unsachgemäßen Einsatz.
- Bei Instandsetzung nur Originalteile verwenden.
- Tragfähigkeit der Decke und Befestigungselemente sicherstellen.

### Betrieb der Leuchte

- Die unzulässigen Umgebungstemperaturen reduzieren die Lebensdauer der Leuchte, im Extremfall droht der Frühausfall.
- Zur Vermeidung von EMV-Problemen die Durchgangsverdrahtung nicht entlang der Leuchtenverdrahtung führen.
- Steuereingänge von dimmbaren Leuchten mit handelsüblichen für Netzspannung geeigneten Leitungen anschließen.

### Manipulationen unserer Produkte sind unzulässig

Veränderung, Umarbeitung, Umkennzeichnung von Produkten sowie deren Verpackung sind unzulässig und verletzen u.a. unsere eingetragenen Warenzeichenrechte. Solche Modifikationen können technische Eigenschaften unserer Produkte negativ beeinflussen, diese zerstören und möglicherweise Folgeschäden an anderen Objekten verursachen. Für durch derartige Modifikationen verursachte Schäden kann der Hersteller in keinem Fall verantwortlich gemacht werden.



### General Safety Information

- Electric connection must be appropriate according to all applicable standards and other national and international safety and accident prevention regulations.
- Damaged luminaires must not be operated.
- No liability is accepted for damages resulting from improper use.
- Use genuine parts only for repair.
- Ensure stability of the ceiling and fastening elements.

### Operation of the luminaire

- Exceeding the permissible ambient temperature will reduce the luminaire's lifecycle, resulting in premature failure in extreme cases.
- Avoid ESD problems by not routing feed-through wiring directly along the wiring of the luminaire.
- Connect control inputs of dimmable luminaires with standard cables suitable for power supply voltage.

### Manipulation of our products is not permitted

Modifications, reworking, re-labelling of products as well as their package is not permitted and infringes, amongst others, our registered trademark rights. Such modifications may affect technical properties of our products, damage them and possibly cause consequential damage to other objects. The manufacturer shall not be responsible under any circumstances for damage caused by such modifications.



Bei Fragen zu unseren Symbolen, besuchen Sie folgende Webseite:  
If you have any questions about our signs, visit the following website:



[https://www.rzb.de/fileadmin/assets/downloads/PDF/RZB\\_Symbolklaerung.pdf](https://www.rzb.de/fileadmin/assets/downloads/PDF/RZB_Symbolklaerung.pdf)

**EEK** 

Dieses Produkt enthält eine Lichtquelle der Energieeffizienzklasse E entsprechend Verordnung (EU) 2019/2015



This product contains a light source of energy efficiency class E according to regulation (EU) No 2019/2015

 → 

Jede zersprungene Schutzabdeckung ist zu ersetzen. DIN EN 60598

 → 

Replace any cracked protective shield. IEC DIN EN 60598

Die Lichtquelle dieser Leuchte darf nur vom Hersteller oder einem von ihm beauftragten Servicetechniker oder einer vergleichbar qualifizierten Person ersetzt werden. DIN EN 60598-1 / IEC 60598-1

The light source contained in this luminaire shall only be replaced by the manufacturer or his service agent or a similar qualified person. DIN EN 60598-1 / IEC 60598-1



Hinweis zum Einsatz von Leuchten mit D - Kennzeichnung nach EN 60598-2-24  
 Reference for application of lumiaires with D - marking according to EN 60598-2-24



IP 4x

Umgebung ohne Staubablagerung  
 Environment without dust deposit



IP 5x

Umgebung mit nicht elektrisch leitender Staubablagerung  
 Environment with non-electrically conductive dust deposit



IP 6x+

Umgebung mit elektrisch leitender Staubablagerung  
 Environment with electrically conductive dust deposit



IP 54



IP 50

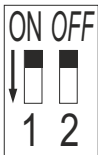
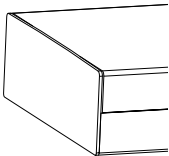

312621.002			
	[mA]	$\Phi_{\text{D}}$ [lm]	$P_{\text{D}}$ [W]
	200	1250	10
	250	1550	12
	300	1850	15
	350	2050	17

312622.002			
	[mA]	$\Phi_{\text{D}}$ [lm]	$P_{\text{D}}$ [W]
	500	3150	25
	600	3800	29
	700	4300	34
	800	4750	38

312623.002			
	[mA]	$\Phi_{\text{D}}$ [lm]	$P_{\text{D}}$ [W]
	900	5500	42
	1050	6300	49
	1100	6550	51
	1200	7150	57

312621.002.1			
	[mA]	$\Phi_{\text{D}}$ [lm]	$P_{\text{D}}$ [W]
	200	1300	10
	250	1600	12
	300	1900	15
	350	2100	17

312622.002.1			
	[mA]	$\Phi_{\text{D}}$ [lm]	$P_{\text{D}}$ [W]
	500	3300	25
	600	3950	29
	700	4450	34
	800	4950	38

312623.002.1			
	[mA]	$\Phi_{\text{D}}$ [lm]	$P_{\text{D}}$ [W]
	900	5700	42
	1050	6550	49
	1100	6800	51
	1200	7400	57

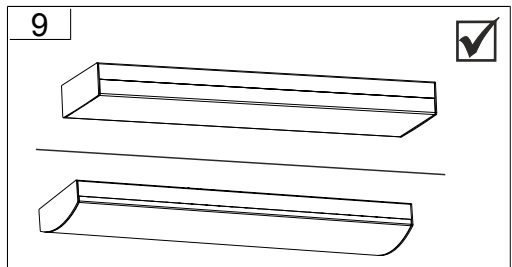
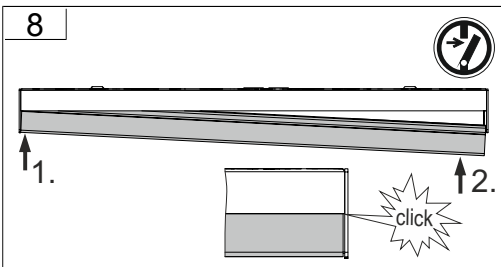
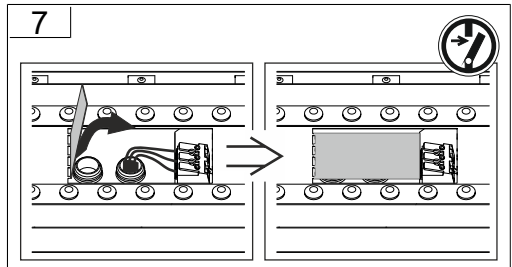
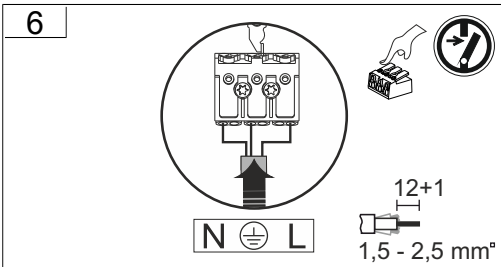
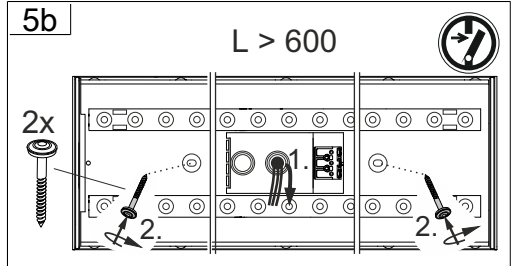
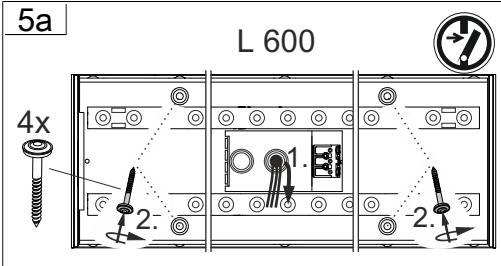
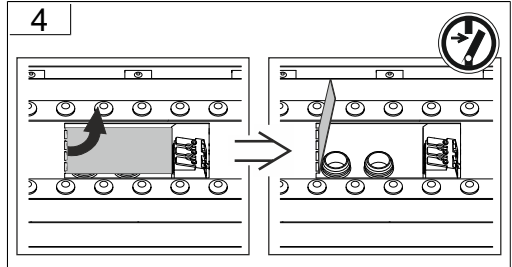
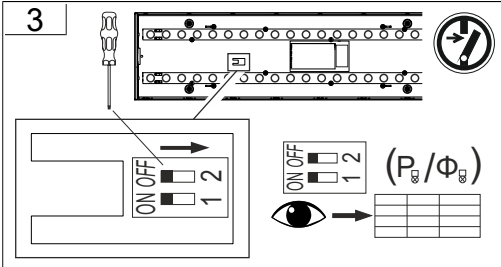
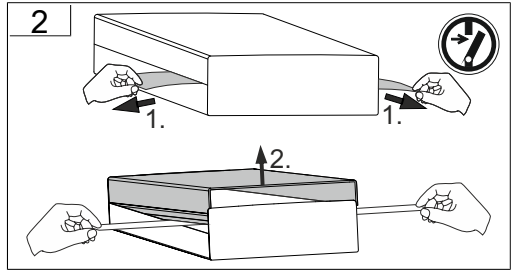
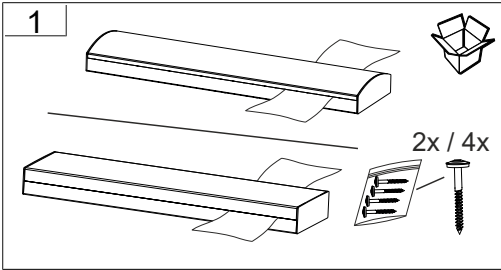
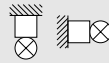

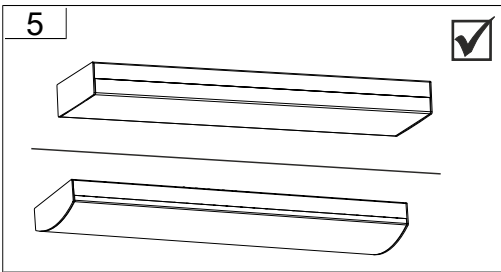
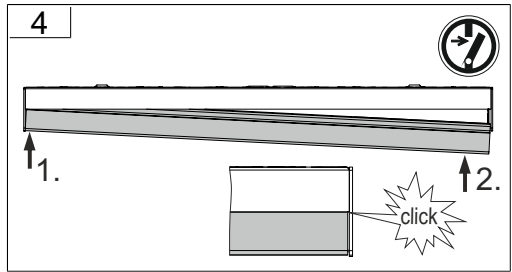
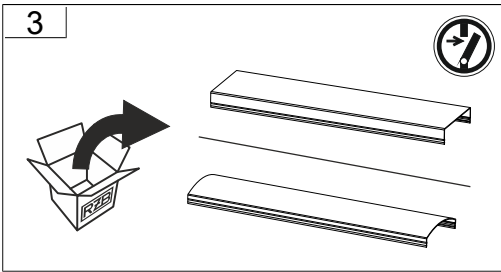
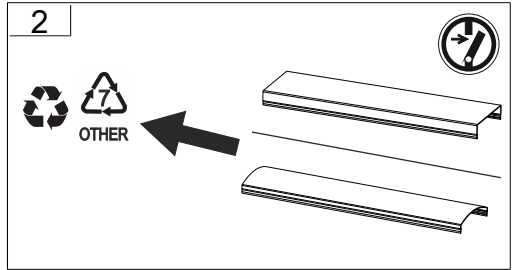
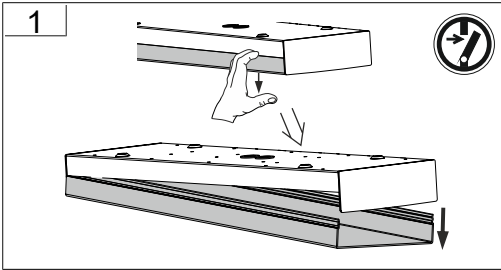

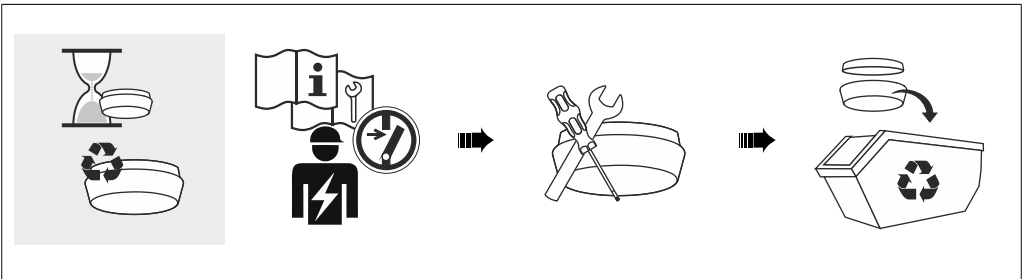
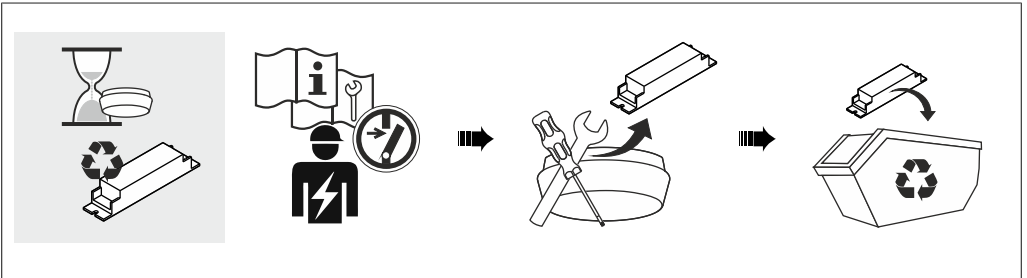
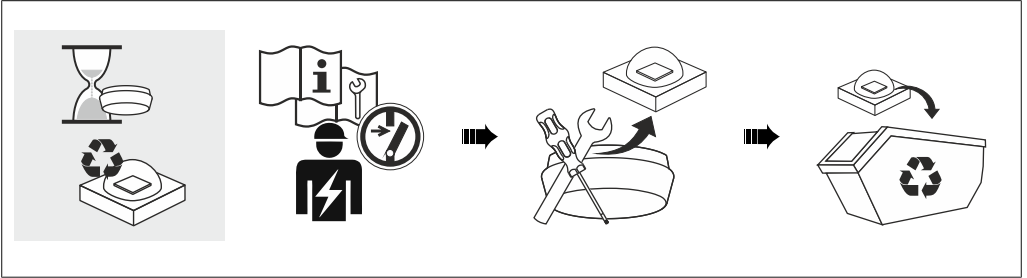

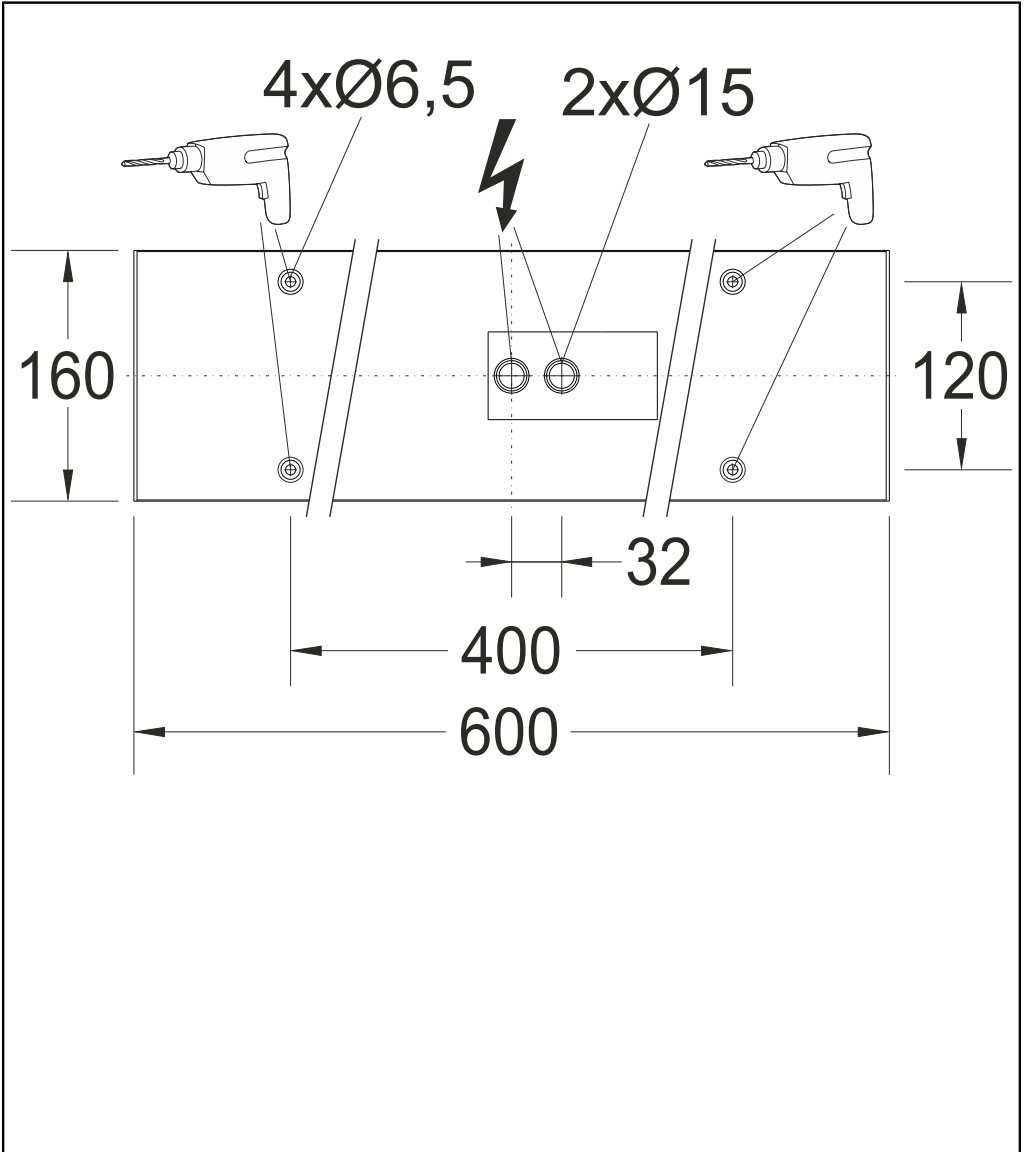

RZB - Rudolf Zimmermann, Bamberg GmbH

🏠 Rheinstraße 16, 96052 Bamberg

☎ 0951/7909-0

📄 0951/7909-198

🌐 [info@rzb-leuchten.de](mailto:info@rzb-leuchten.de)