

Modicon M340, CANopen, Altivar, Lexium, TeSysU and Preventa *System User Guide*

[source code]

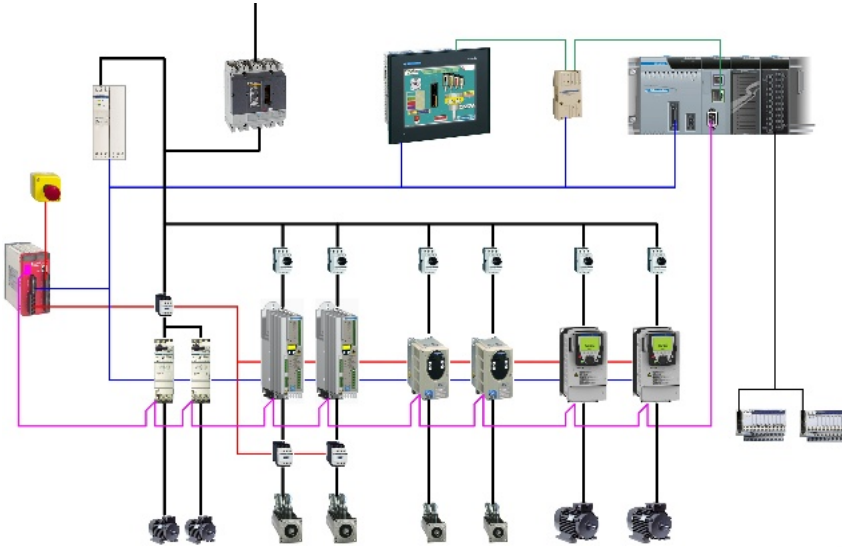

Preferred Implementation:
Compact Evolutive Performance

33004041.00

Merlin Gerin
Square D
Telemecanique

Schneider
 **Electric**
Building a New Electric World

JAN 2007

Contents

Application Source Code	4
Typical Applications	5
System	6
Architecture	6
Installation	9
Hardware	11
Software	25
Communication	26
Implementation	38
Communication	39
PLC.....	47
HMI	83
Devices.....	100
Safety controller	101
Lexium 15 LP	117
Lexium 05	131
Altivar 71.....	137
TeSysU	142
Performance.....	144
Appendix	145
Detailed Component List	145
Component Protection Classes	147
Component Features	148
Contact	153

Introduction

This document is intended to provide a quick introduction to the described System. It is not intended to replace any specific product documentation. On the contrary, it offers additional information to the product documentation, for installing, configuring and starting up the system.

A detailed functional description or the specification for a specific user application is not part of this document. Nevertheless, the document outlines some typical applications where the system might be implemented.

Abbreviations

Word / Expression	Signification
AC	Alternating Current
Advantys	SE product name for a family of I/O modules
Altivar (ATV)	SE product name for a family of VSDs
CANopen	Name for a communications machine bus system
CB	Circuit Breaker
CoDeSys	Hardware-independent IEC 61131-3 programming software
ConneXium	SE product name for a Family of Transparent Factory devices
DC	Direct Current
EDS	Electronic Data Sheet
E-OFF, E-STOP	Emergency Off switch
Harmony	SE product name for a family of switches and indicators
HMI	Human Machine Interface
I/O	Input/Output
IcIA (ICLA)	SE product name for a compact drive
Lexium/Lexium05/LXM	SE product name for a family of servo-drives
M340 / Modicon M340	SE product name for a mid range PLC family
Magelis	SE product name for a family of HMI-Devices
MFB	PLCopen Motion Function Block
MB - SL	SE name for a serial Modbus communications protocol
Micro	SE product name for a middle range family of PLCs
NIM	SE product name for a Network Interface Module
Osi switch	SE product name for a family of position switches
PC	Personal Computer
PDO	Process Data Object (CANopen)
Phaseo	SE product name for a family of power supplies
PLC	Programmable Logic Computer
PowerSuite	An SE software product for configuring drives
Premium	SE product name for a middle range family of PLCs
Preventa	SE product name for a family of safety devices
PS1131 (CoDeSys)	SE Product name for PLC programming software with CoDeSys
PS	Power Supply
RPDO	Receive Process Data Object (CANopen)
SE	Schneider Electric
SDO	Service Data Object
SyCon	SE product name of a Field bus programming software

Word / Expression	Signification
Telefast	SE product name for a series of distributed I/O devices
TesysU	SE product name for a decentralized I/O System
TPDO	Transmit Process Data Object (CANopen)
Twido	SE product name of a basic range family of PLCs
TwidoSoft	SE product name for a PLC programming software
TwidoSuite	SE product name for a PLC programming software
Unity (Pro)	SE product name for a PLC programming software
Vijeo Designer	An SE software product for programming Magelis HMI devices
VSD	Variable Speed Drive
WxHxD	Dimensions : Width, Height and Depth
XBT-L1000	An SE software product for programming Magelis HMI devices
Zelio	SE product name for a low range PLC family
ZelioSoft	SE product name for a PLC programming software

Application Source Code

Introduction

Examples of the source code and wiring diagrams used to attain the system function as described in this document can be downloaded from our website under [this](#) link.

The example source code is in the form of configuration, application and import files. Use the appropriate software tool to either open or import the files.

Extension	File Type	Software Tool Required
AIW	Configuration file	Advantys
CNF	C onfiguration F ile	SyCon
CO	CAN open definitions file	SyCon
CSV	C omma S eparated V alues, Spreadsheet	Twidosoft
CTX		Unity
DCF	D evice C onfiguration F ile	Advantys
DIB	D evice I ndependent B itmap	SyCon
DOC	D ocument file	Microsoft Word
DOP	Project File	Magelis XBTL 1000
EDS	E lectronic D ata S heet – Device Definition	Industrial standard
FEF	Export file	PL7
GSD	EDS file (G eraete S tamm D atei)	Profibus
ISL	I sland file, project file	Advantys
PB	P rofibus definitions file	SyCon
PDF	P ortable D ocument F ormat - document	Adobe Acrobat
PRO	Project file	PS1131 - CoDeSys
PS2	Export file	PowerSuite
RTF	R ich T ext F ile - document	Microsoft Word
SPA	Schneider Product Archive	TwidoSuite
STA	Project Archive	Unity Pro
STU	Project file	Unity Pro
STX	Project file	PL7
TLX	Project file	Twinline control tool
TWD	Project file	TwidoSoft
VDZ	Project file	Vijeo Designer
XEF	Export file	Unity Pro
XPR	Project file	TwidoSuite
ZM2	Project file	Zeliosoft

Typical Applications

Introduction

Here you will find a list of the typical applications, and their market segments, where this system or subsystem can be applied:

Industry:

Food & beverage

- Meat processing
- Trimmers
- Mixers

Metal processing

- Bending machines



Packaging

- Cartoning machines
- Palletizers
- Blister packaging machines

Buildings:

HVAC (Heating, ventilation and air-conditioning systems)

- Refrigeration machines
- Cooling towers

Application	Description	Image
Packaging Machine	Suitable for collecting products of any shape, size and consistency, in rows and layers. Handles several kinds of packages from simple products to bundles.	
Bottling Machine	For the packaging industry used for labelling, packing, filling and palletting the goods.	
Transporting materials Pick-and-place machines	Assembly machines that can handle tools and products with a great versatility of size, closes the package and sorts it.	

System

Introduction

The system chapter describes the architecture, the dimensions, the quantities and different types of components used within this system.

Architecture

General

The control section of this application consists of a Modicon M340 PLC, which can be operated via a connected Magelis HMI panel at user level. The device section is implemented using Lexium 15, Lexium 05, Altivar 71 and TeSysU, which are connected to the PLC via the CANopen bus system.

The solution illustrated below includes Preventa safety components featuring tamper-proof emergency off switches.

Layout

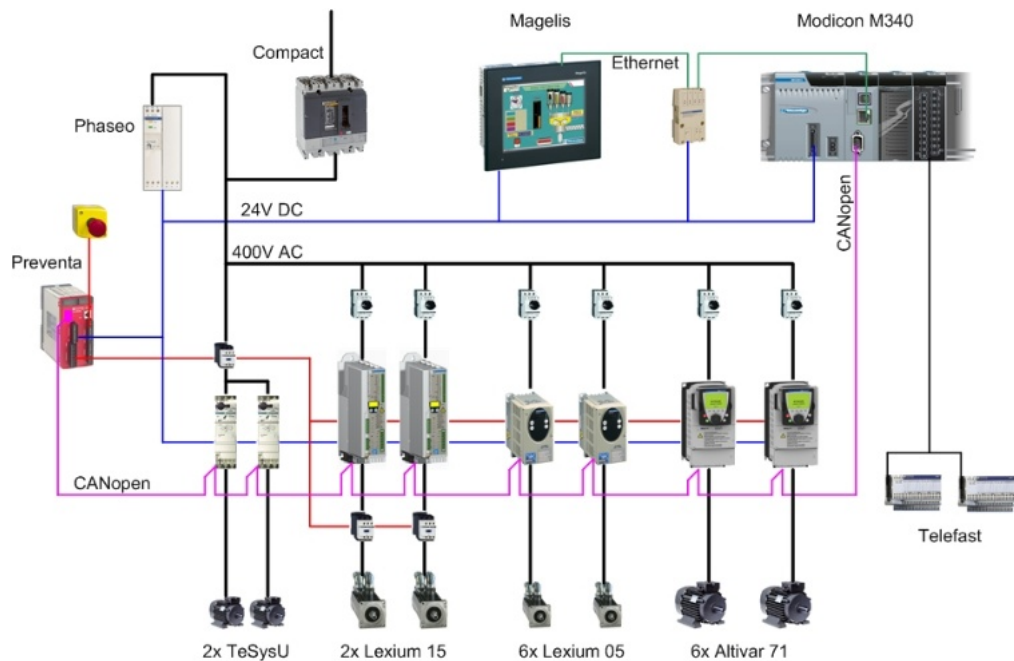

Components

Hardware:

- Compact master switch (NS100N)
- GV2-L motor circuit breaker (short-circuit protection)
- Modicon M340 PLC with CANopen and Ethernet interface
- Magelis XBTGT HMI panel
- Preventa XPSMC safety controller
- Lexium 15 LP servo drive
- Lexium 05 servo drive
- Altivar ATV71 variable speed drive
- TeSysU motor starter
- TeSys K and TeSys D (LP1K and LC1D) load contactors

Software:

- Unity Pro V3.0
 - Vijeo Designer V4.40
 - XPSMCWIN V2.00
 - PowerSuite V2.30
 - UniLink L V1.50
-

Quantities of Components

For a complete and detailed list of components, the quantities required and the order numbers, please refer to the components list at the rear of this document.

Degree of Protection

Not all the components in this configuration are designed to withstand the same environmental conditions. Some components may need additional protection, in the form of housings, depending on the environment in which you intend to use them. For environmental details of the individual components please refer to the list in the appendix of this document and the appropriate user manual.

Technical Data

Mains voltage	400 V AC
Power requirement	~ 6 kW
Drive power rating	2x 1.3 kW, 12x 0.75 kW , 2x 0.25kW
Motor brake	None
Connection	5x 2.5mm ² (L1, L2, L3, N, PE)
Safety level	Cat. 3

Safety Notice

The standard and level of safety you apply to your application is determined by your system design and the overall extent to which your system may be a hazard to people and machinery.

As there are no moving mechanical parts in this application example, category 3 (according to EN954-1) has been selected as an optional safety level.

Whether or not the above safety category should be applied to your system should be ascertained with a proper risk analysis.

This document is not comprehensive for any systems using the given architecture and does not absolve users of their duty to uphold the safety requirements with respect to the equipment used in their systems or of compliance with either national or international safety laws and regulations

Dimensions

The dimensions of the individual devices used; PLC, Drive, Power supply, etc. require a housing cabinet size of at least 800x600x300mm (WxHxD).

The HMI display, illuminated indicators such as "SYSTEM ON", "SYSTEM OFF" or "ACKNOWLEDGE EMERGENCY OFF" as well as the Emergency Off switch itself, can be built into the door of the housing.

Installation

Introduction

This chapter describes the steps necessary to set up the hardware and configure the software required to fulfill the described function of the application.

Assembly



Assembly
contd.



Hardware

General



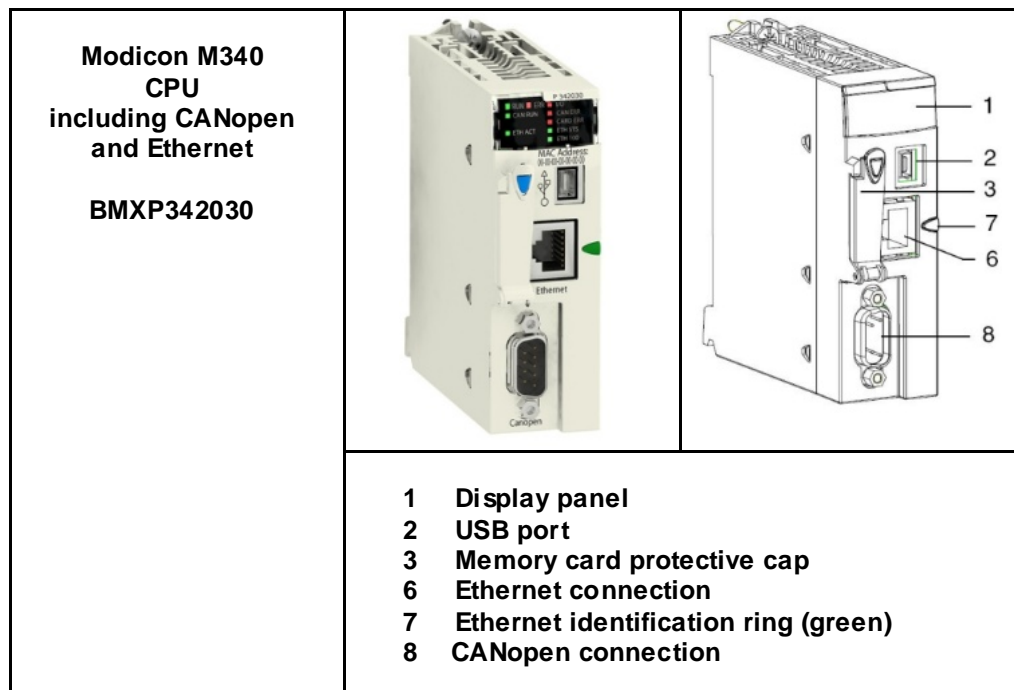

- The components designed for installation in a control cabinet, i.e., the safety controller, line circuit breakers, contactors, motor circuit breakers and motor starters, can be mounted on a 35 mm top-hat rail.
- Master switches, the Phaseo power supply unit, variable speed drives and servo drives are screwed directly onto the mounting plate.
- Emergency Off switches and the pushbutton housing for display and acknowledgement indicators are designed for backplane assembly in the field. All switches can also be installed directly in a control cabinet (e.g., in a cabinet door) without the need for their enclosing housings.
- There are two options for installing XB5 pushbuttons or indicator lamps: These pushbuttons or switches can be installed either in a 22 mm hole, e.g., drilled into the front door of the control cabinet, or in an XALD-type housing suitable for up to 5 pushbuttons or indicator lamps. The XALD pushbutton housing is designed for backplane assembly or direct wall mounting.
- The Magelis operator and display terminals require a cut-out in the front of the housing so that they can be secured to the housing wall using brackets/spring clamps.
- 400 V/3-phase AC wiring for the load circuits (LXM15, LXM05, ATV71, TeSysU).
- 240 V AC wiring for the power supplies.
- 24 V DC wiring for control circuits and the PLC power supply, operator and display terminals, I/O modules and the HMI.

The individual components must be interconnected in accordance with the detailed circuit diagram in order to ensure that they function correctly.

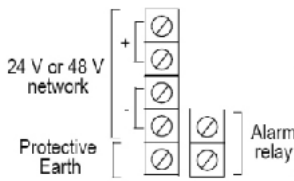
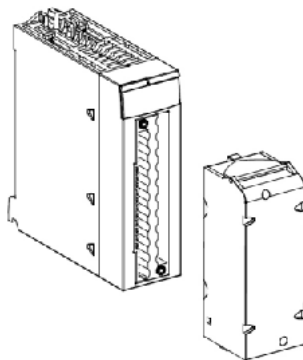
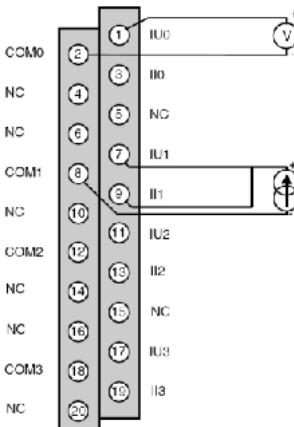
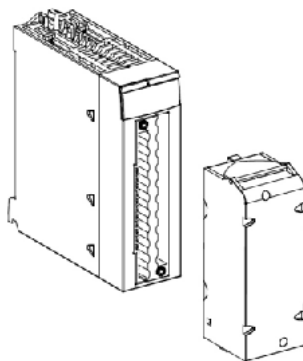
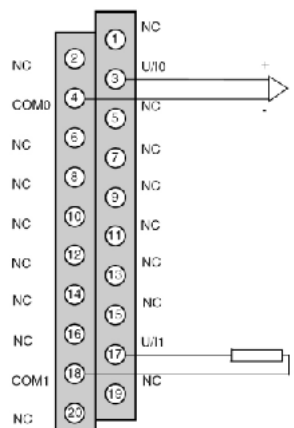
CANopen cables are installed for the communication link between the PLC and the devices inside the control cabinet.

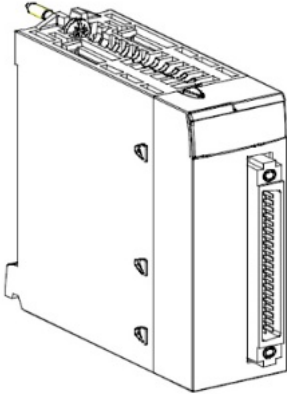
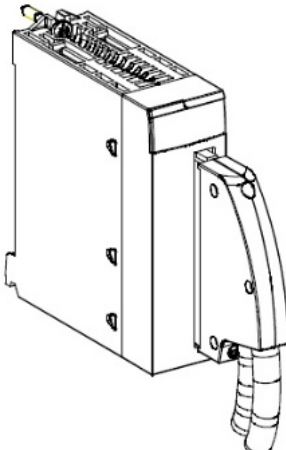

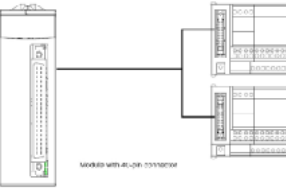
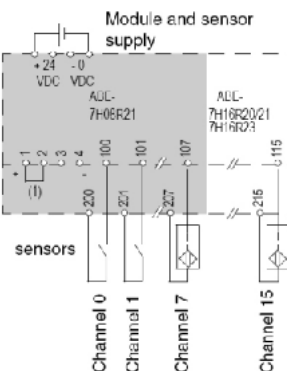
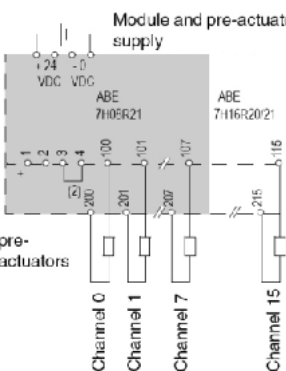
<p>Modicon M340</p> <p>Power supply</p> <p>BMXCPS3020</p>		
<p>Modicon M340</p> <p>Analog I/O modules</p> <p>4 inputs</p> <p>BMXAMI0410</p>		
<p>Modicon M340</p> <p>Analog I/O modules</p> <p>2 outputs</p> <p>BMXAMO0210</p>		

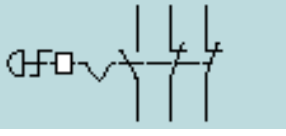
<p>Modicon M340</p> <p>Digital I/O modules for Telefast</p> <p>32 inputs BMXDDI3202K</p> <p>32 outputs BMXDDO3202K</p> <p>16 inputs/16 outputs BMXDDM3202K</p>		
<p>Telefast for 16 I/O ABE7H16R21</p> <p>Connection cable BMXFCC303</p>		
<p>16 inputs</p> <p>Two I/O blocks are connected to each I/O module using the connection cable referred to above.</p>	<p>16 inputs</p> 	<p>16 outputs</p> 
<p>EMERGENCY OFF switch (tamper-proof)</p> <p>XALK178G</p>		

**Preventa
safety controller
with CANopen**

XPSMC16ZC

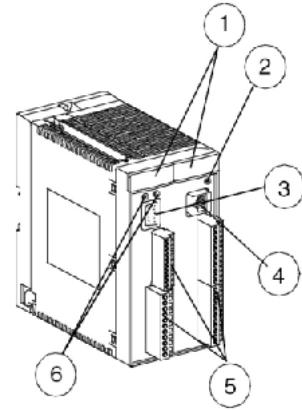

- 1 Display panel
- 2 RESET button
- 3 CANopen connection
- 4 TER connection
- 5 Terminals
- 6 CANopen LEDs

Further details about the terminals (5):

- A1-A2 24 V power supply (A1: positive; A2: negative)
- GND Ground
- o1-o6 Semiconductor safety outputs
- 13-44 Volt-free safety outputs with contacts
- c1-c8 Control outputs
- i1-i16 Safety inputs
- H1 Muting lamp connection

**Preventa
expansion module**

XPSECP5131

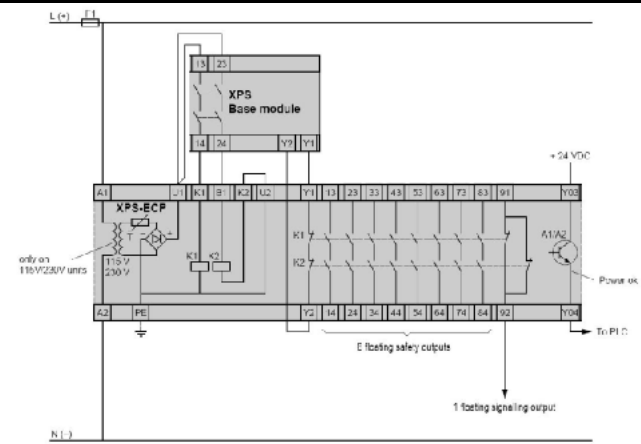

**Lexium 15 LP
servo drive**

LXM15LD28M3

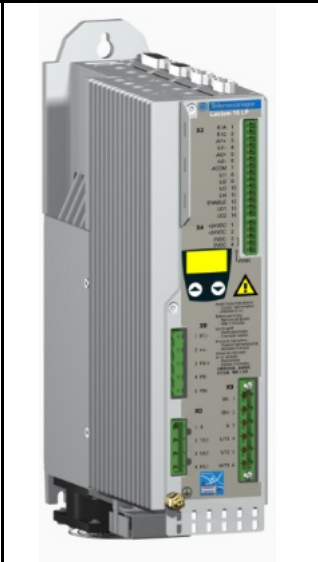

**Lexium 15 LP
servo drive**

LXM15LD28M3

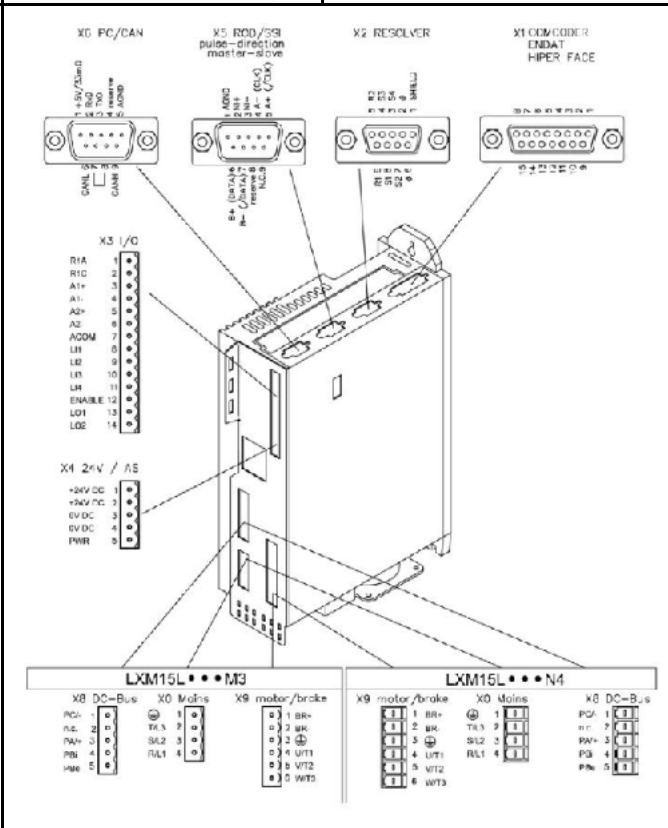

**Lexium 15 LP
servo drive**

LXM15LD28M3

**-X0
Power terminal**

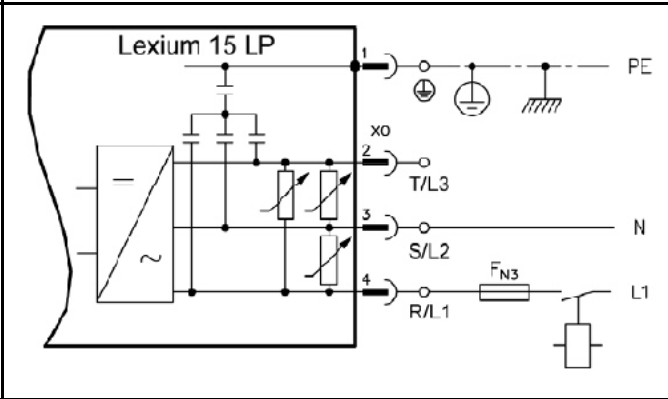

<p>Lexium 15 LP servo drive</p> <p>LXM15LD28M3</p> <p>-X4 Control voltage</p>	
<p>Lexium 15 LP servo drive</p> <p>-X9 Motor cable connection terminal (cable length: 3 m)</p> <p>VW3M5101R30</p>	
<p>Lexium 15 LP servo drive</p> <p>-X1 Encoder cable connection terminal (cable length: 3 m)</p> <p>VW3M8301R30</p>	

**Lexium 15 LP
servo drive**

LXM15LD28M3

Overview

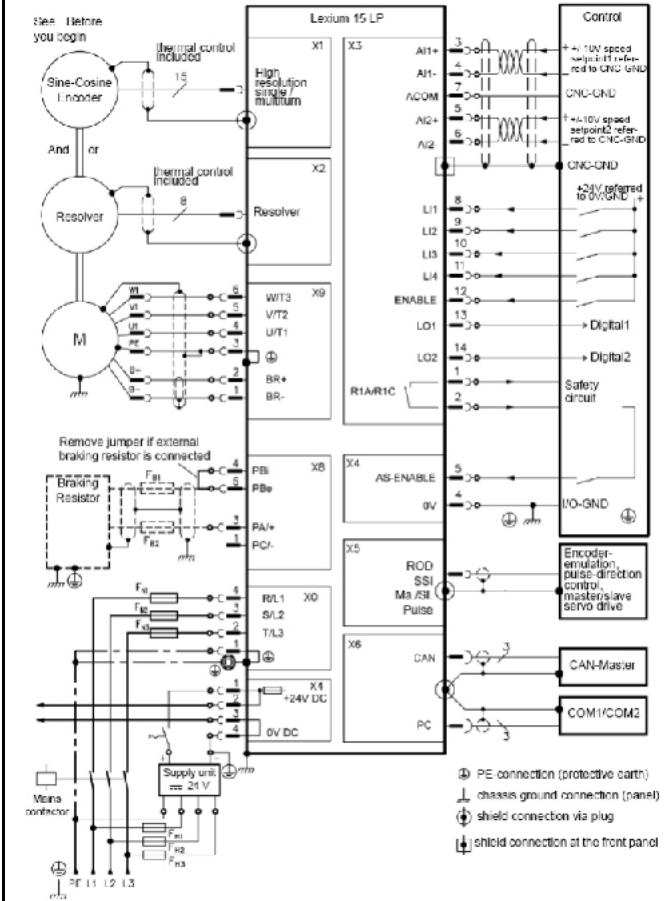

**Single-phase
Lexium 05
servo drive**

LXM05AD14N4

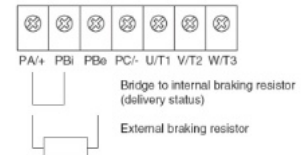

Power connections	Description
PE	Earth connection (protective earth)
R/L1, S/L2/N	Mains connection, single phase devices
R/L1, S/L2, T/L3	Mains connection, 3-phase devices
PA/+	DC bus
PBi	Braking resistor internal
PBe	Braking resistor external
PC/-	DC bus
U/T1, V/T2, W/T3	Motor connections

<p>Single-phase Lexium 05 servo drive</p> <p>LXM05AD14N4</p> <p>Power terminals see T4</p>	<div style="display: flex; justify-content: space-between;"> <div style="width: 60%;"> <p>T1</p> <p>T2</p> <p>T3</p> <p>T4</p> <p>T5</p> </div> <div style="width: 35%;"> <p>LXM05•...</p> <p>D10F1 (T1)</p> <p>D10M2 (T1)</p> <p>D10M3X (T2)</p> <p>D14N4 (T4)</p> <p>D17F1 (T3)</p> <p>D17M2 (T4)</p> <p>D17M3X (T4)</p> <p>D22N4 (T4)</p> <p>D28F1 (T3)</p> <p>D28M2 (T4)</p> <p>D34N4 (T4)</p> <p>D42M3X (T4)</p> <p>D57N4 (T5)</p> </div> </div>																		
<p>Single-phase Lexium 05 servo drive</p> <p>Motor cable connection terminal (cable length: 3 m)</p> <p>VW3M5101R30</p>	<div style="text-align: center;"> <p>Motor wiring diagram, here without holding brake</p> </div> <table border="1" style="width: 100%; border-collapse: collapse;"> <thead> <tr> <th>Terminal</th> <th>Description</th> <th>Colour</th> </tr> </thead> <tbody> <tr> <td>U/T1</td> <td>Motor lead</td> <td>black L1 (BK)</td> </tr> <tr> <td>V/T2</td> <td>Motor lead</td> <td>black L2 (BK)</td> </tr> <tr> <td>W/T3</td> <td>Motor lead</td> <td>black L3 (BK)</td> </tr> <tr> <td>PE</td> <td>Protective conductor</td> <td>green/yellow (GN/YE)</td> </tr> <tr> <td>(1)</td> <td>Holding brake connection cable For motors with holding brake</td> <td>white (WH), grey (GR)</td> </tr> </tbody> </table>	Terminal	Description	Colour	U/T1	Motor lead	black L1 (BK)	V/T2	Motor lead	black L2 (BK)	W/T3	Motor lead	black L3 (BK)	PE	Protective conductor	green/yellow (GN/YE)	(1)	Holding brake connection cable For motors with holding brake	white (WH), grey (GR)
Terminal	Description	Colour																	
U/T1	Motor lead	black L1 (BK)																	
V/T2	Motor lead	black L2 (BK)																	
W/T3	Motor lead	black L3 (BK)																	
PE	Protective conductor	green/yellow (GN/YE)																	
(1)	Holding brake connection cable For motors with holding brake	white (WH), grey (GR)																	

Single-phase
Lexium 05
servo drive

LXM05AD14N4

Signal terminals

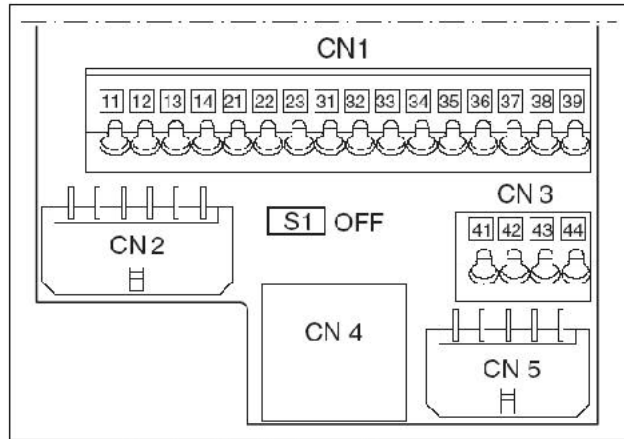

Overview of the signal connections

Connection/ Assignments
switch

CN1	Analogue inputs $\pm 10V$, pin 11 to 14 CANopen, pin 21-23 Digital inputs/outputs, pin 31-39
CN2	Motor encoder (Hiperface Sensor)
CN3	24V PELV controller supply voltage
CN4	PC, peripheral operating terminal, Modbus, CANopen; (RJ45)
CN5	ESIM (A/E/I out), PULSE/DIR in, encoder signals A/B/I in ¹⁾
S1	Switch for fieldbus terminating resistor

1) depending on the "First Setup"

Single-phase
Lexium 05
servo drive

Encoder cable
connection terminal
(cable length: 3 m)

VW3M8101R30

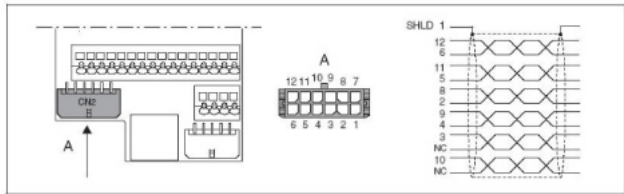

Motor sensor wiring diagram

Pin	Signal	Motor, pin	Colour ¹⁾	Pair	Description	I/O
1	SHLD				Shielding braid	
12	SIN	8	white	1	Sine signal	E
6	REFSIN	4	brown	1	Reference for sine signal, 2.5 V	A
11	COS	9	green	2	Cosine signal	E
5	REFCOS	5	yellow	2	Reference for cosine signal, 2.5V	A
8	Data	6	grey	3	Receive and transmit data	I/O
2	DIR	7	pink	3	Receive and transmit data, inverted	I/O
10	EHC_OV	11	blue	4	sensor reference potential (encoder) (0.5mm ²)	A
			red	4	not assigned (0.5mm ²)	
3	TMOT_OV	1	black	5	Reference potential for T_MOT	-
			purple	5	not assigned	
9	T_MOT	2	grey/pink	6	temperature sensor PTC	E
4	EHC+10V_OUT	10	red/blue	6	10 V _{DC} power supply for sensor, max. 150 mA	A
7	n.c.				not assigned	

1) Colour data is based on the prefabricated cables

Single-phase
Lexium 05
servo drive

LXM05AD14N4

Control power supply

HBC = Holding brake
control

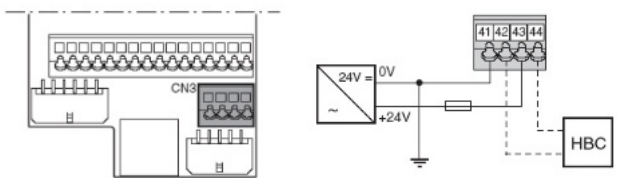

Pin	Signal	Description
41	0VDC	Reference potential for 24V voltage
42	0VDC	Reference potential for 24V voltage
43	+24VDC	24V controller supply voltage
44	+24VDC	24V controller supply voltage

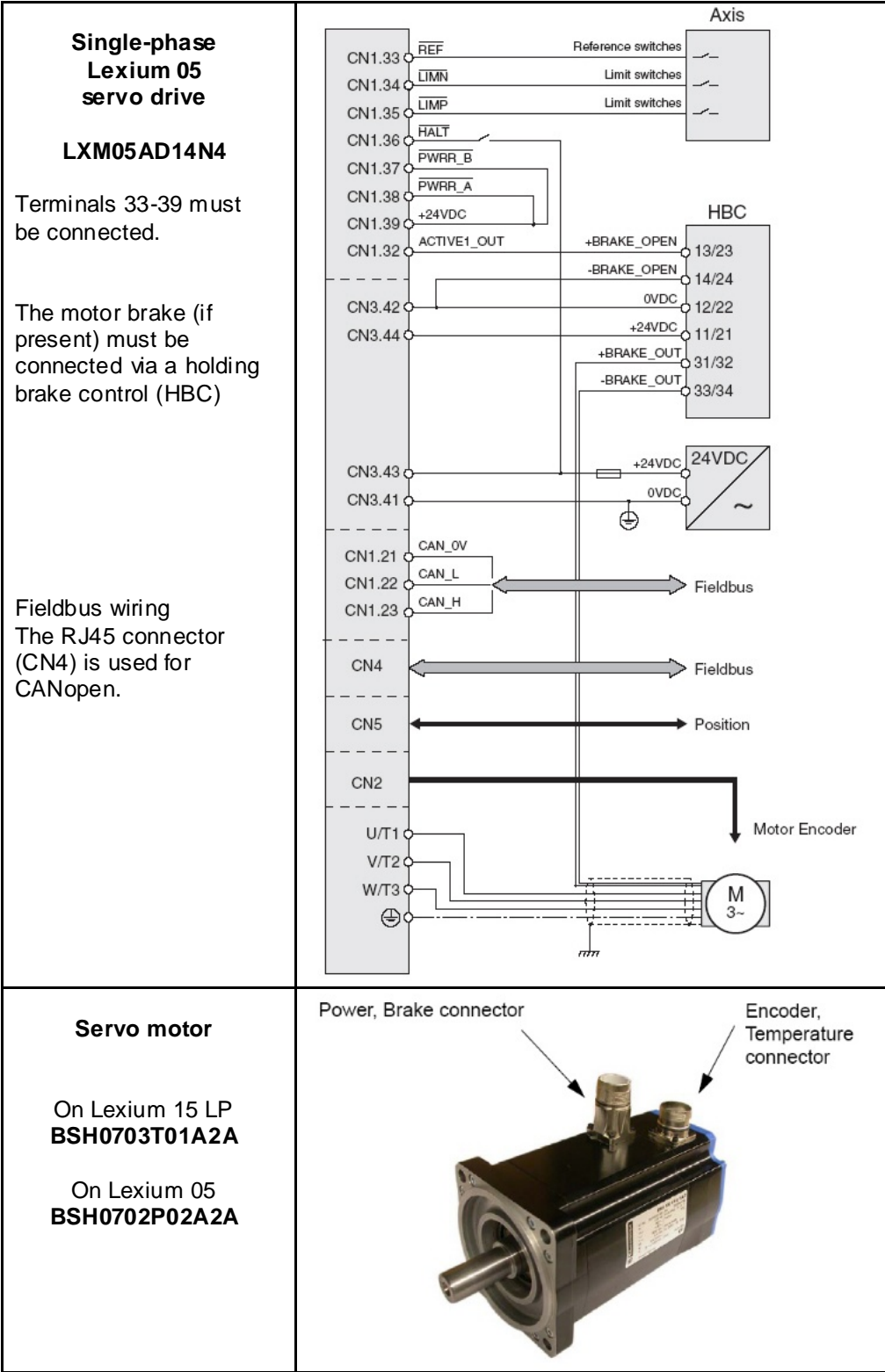

Altivar 71 variable speed drive

ATV71H075N4

Power terminals

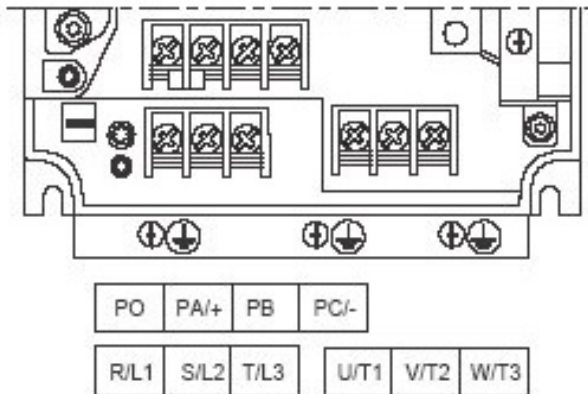

Terminal	Function
⊥	Protective ground connection terminal
R/L1 S/L2 T/L3	Power supply
PO	DC bus + polarity
PA/+	Output to braking resistor (+ polarity)
PB	Output to braking resistor
PC/-	DC bus - polarity
U/T1 V/T2 W/T3	Outputs to the motor

**Altivar 71
variable speed drive**

ATV71H075N4

Control terminals





The following switch positions are used:

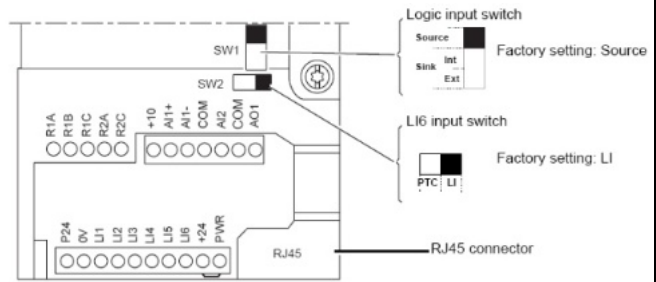



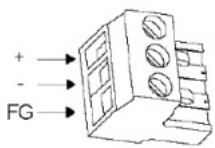
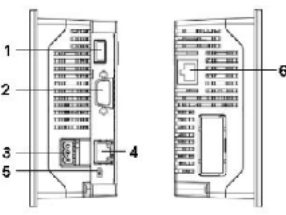

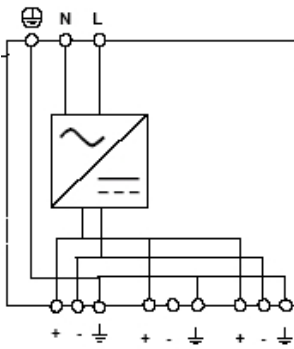
- SW1** - Source
- SW2** - LI

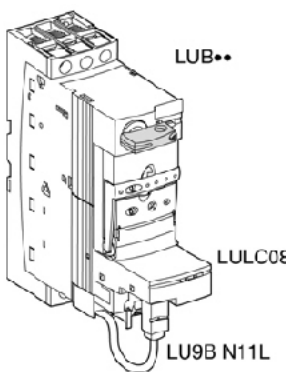
The PWR input of the "Power Removal" safety function is connected to the Emergency Off circuit.

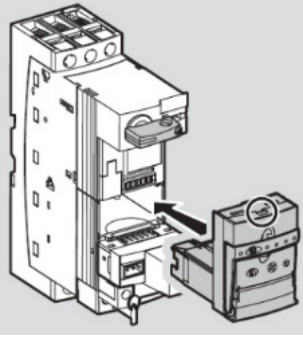
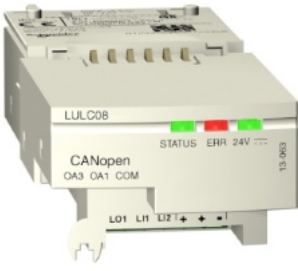
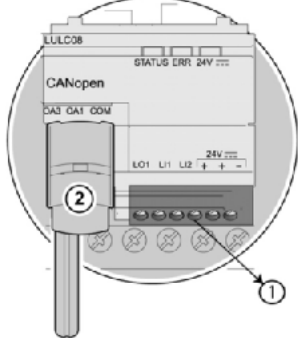

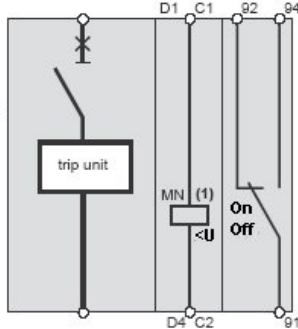
Terminal	Function
R1A R1B R1C	Common point C/O contact (R1C) of programmable relay R1
R2A R2C	N/O contact of programmable relay R2
+10	+10 V $\bar{\bar{}}$ power supply for reference potentiometer 1 to 10 k Ω
AI1+ AI1 -	Differential analog input AI1
COM	Analog I/O common
AI2	Depending on software configuration: Analog voltage input or Analog current input
COM	Analog I/O common
AO1	Depending on software configuration: Analog voltage output or Analog current output
P24	Input for external +24 V $\bar{\bar{}}$ control power supply
0V	Logic input common and 0V of P24 external power supply
L1 L2 L3 L4 L5	Programmable logic inputs
L6	Depending on the position of the SW2 switch. - Programmable logic input or - Input for PTC probes
+24	Logic input power supply
PWR	Power Removal safety function input When PWR is not connected to the 24V, the motor cannot be started (compliance with functional safety standard EN 954-1 and IEC/EN 61508)

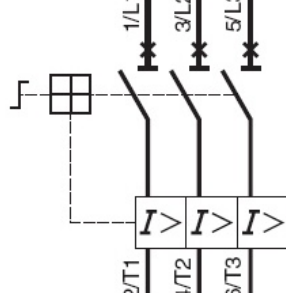
<p>Magelis HMI XBTGT2330</p>	  <p>+ 24 V DC - 0 V FG Ground</p>	 <ol style="list-style-type: none"> 1 USB port (USB 1.1) 2 COM1 serial port (SubD, 9-pin) 3 Current input terminal block (see image on left) 4 COM2 serial port (RJ45) 5 Polarity selector switch 6 Ethernet interface
<p>Phaseo power supply ABL7RE2410</p>		<p>ABL-7RE●●●●</p> 
<p>TeSysU motor starter</p> <p>Power base LUB32</p> <p>CANopen communication module LULC08</p> <p>Coil wiring kit LU9B N11C</p>		

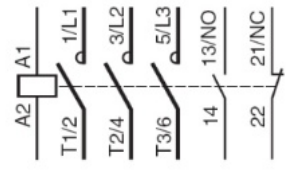
<p>"Advanced" TeSysU trip unit (0.35 A – 1.40 A)</p> <p>LUCB1XBL</p>		
<p>TeSysU CANopen communication module</p> <p>LULC08</p> <p>1 24 V DC power supply 2 Terminal for coil wiring kit</p>		
<p>Master switch</p> <p>Compact NS100N</p>		
<p>Motor circuit breaker</p> <p>GV2 Lxx</p>		
<p>Load contactor</p> <p>LC1 Dxx</p>		

Software

General

Software is primarily used for two reasons: first, for programming the M340 PLC and configuring CANopen communication, and second, for generating visualization.

The PLC is programmed using the Unity Pro programming tool.

The HMI application on the XBTGT 2320 Magelis display terminal is created using Vijeo Designer software.

The Lexium 15 servo drives are parameterized using UniLink software. The Lexium 05 servo drives and Altivar 71 variable speed drives can be parameterized via the front operator panel. However, using the PowerSuite software is much easier. The parameters can be saved and archived using UniLink and PowerSuite. This is extremely useful as it means that parameters can be restored rapidly whenever service tasks need to be performed. The software can also help you to optimize the parameters online.

To use the software packages, your PC must have the appropriate Microsoft Windows operating system installed:

- Windows 2000 *or*
- Windows XP

Note: The description in this documentation is based on English-language versions of the operating system and installed software.

The software tools have the following default install paths

- Unity Pro

C:\Program files\Schneider Electric\Unity Pro



- Vijeo Designer

C:\Program files\Schneider Electric\VijeoDesigner



- XPSMCWIN

C:\Program files\Schneider Electric\Safety Suite\XPSMCWIN



- UniLink L (for Lexium 15 LP)

C:\Program files\Schneider Electric\Unilink L



- PowerSuite

C:\Program files\Schneider Electric\PowerSuite



Communication

General

The methods of communication below are used between devices:

- CANopen
- Ethernet

The machine bus enabling communication between the PLC and fieldbus devices is implemented in the form of **CANopen**. These devices are the safety controller, Lexium, Altivar and TeSysU motor starter.

Ethernet is used for data exchange between the PLC (Modicon M340) and remote HMI (Magelis XBTGT). In addition, the applications can be transferred from the PC to the PLC and HMI via Ethernet.

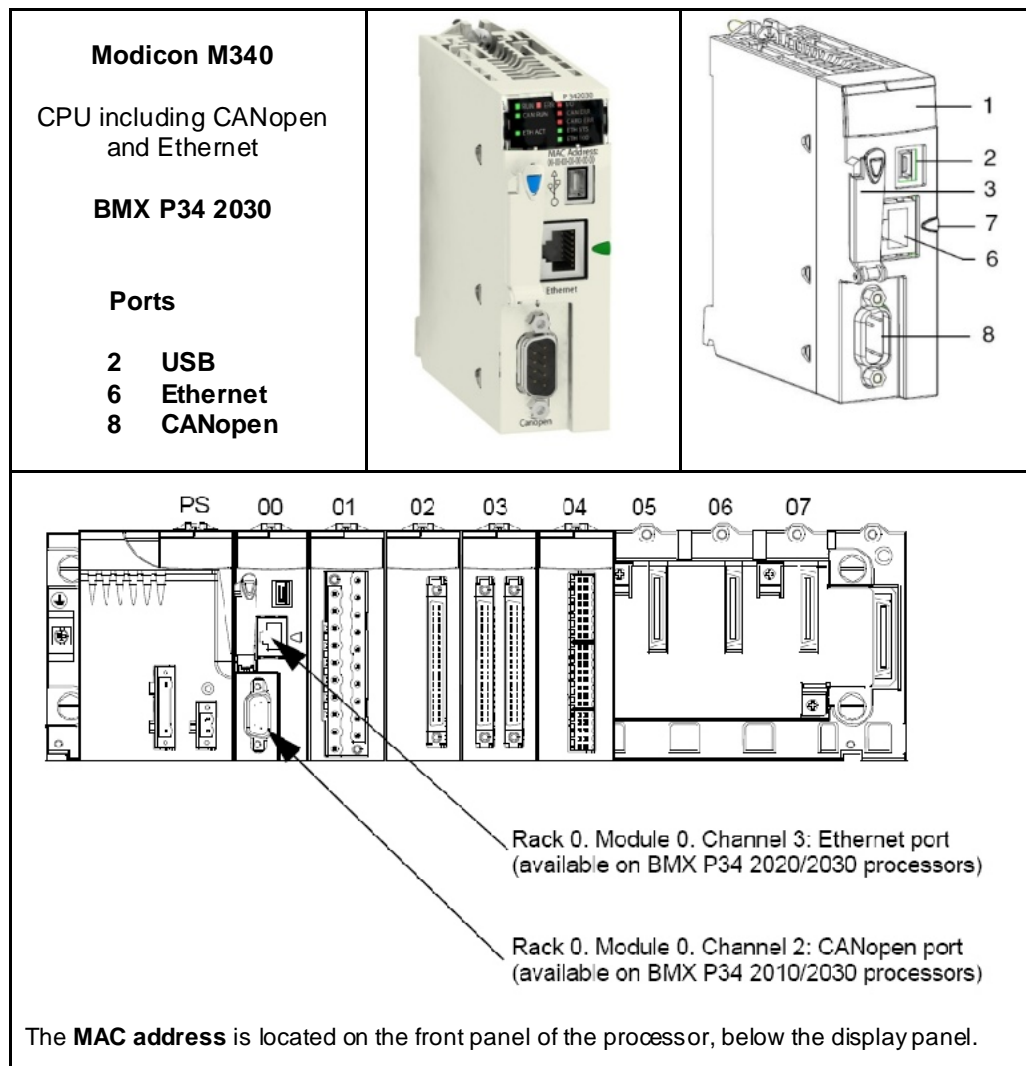

Connection cables are also required between the PC and the individual devices (for programming/parameterization).

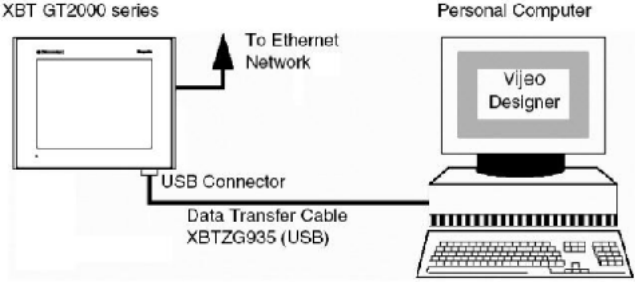
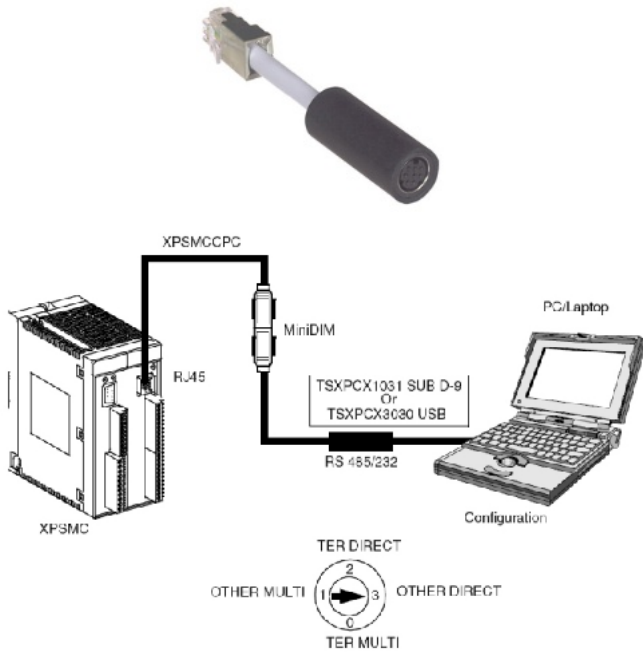

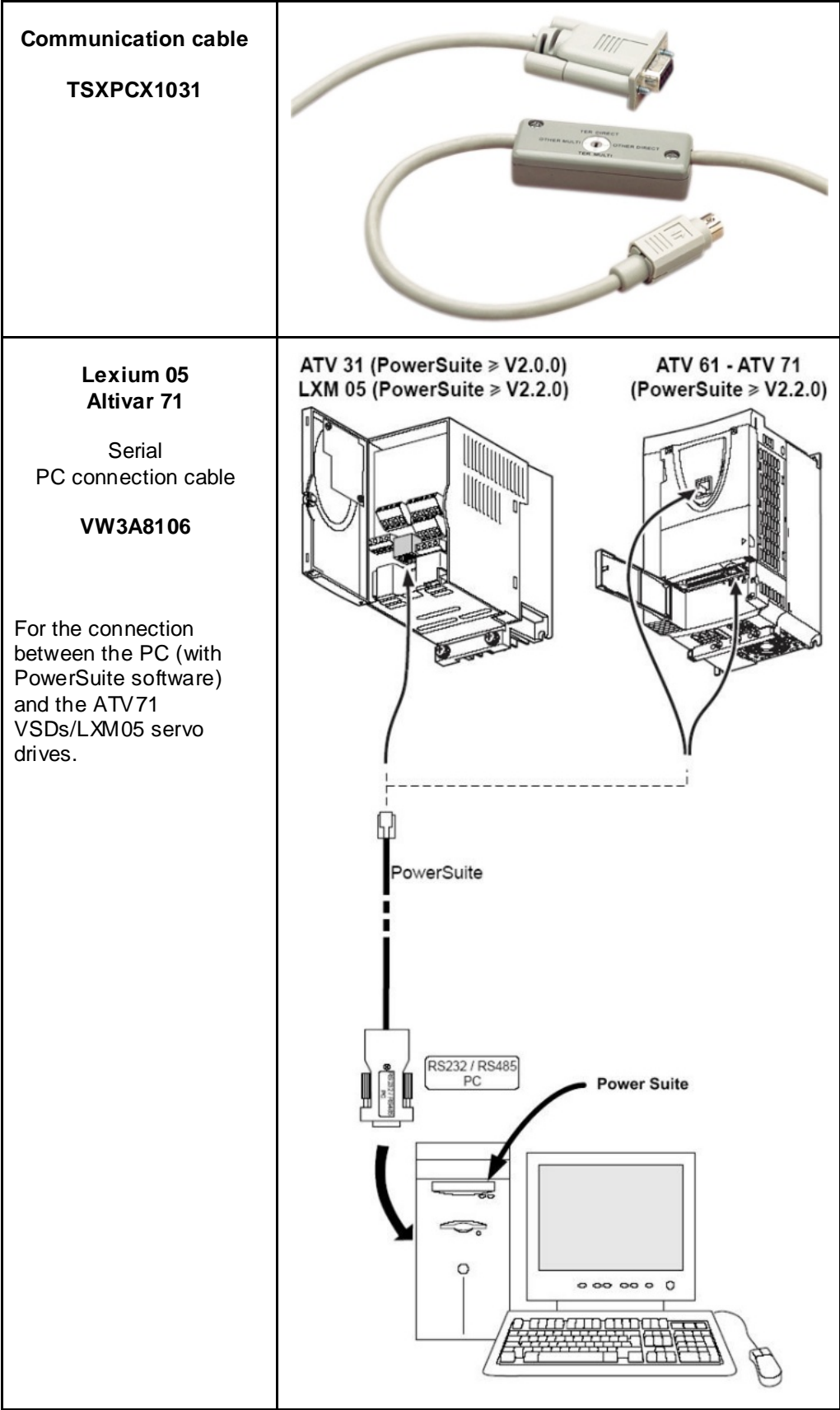
<p>Modicon M340 CPU</p> <p>USB PC connection cable</p> <p>BMXXCAUSB018 (1.8 m)</p> <p>BMXXCAUSB045 (4.5 m)</p>	 <p style="text-align: center;"><i>BMXXCA USB0●●</i></p> <p>For transferring the Unity application from the PC to the PLC.</p> <p>Alternatively, the Ethernet port can be used for connection purposes.</p>
<p>Magelis HMI</p> <p>USB PC connection cable</p> <p>XBTZG935</p>	 <p>For transferring the Vijeo Designer configuration from the PC to the HMI.</p> <p>Alternatively, configuration can be performed via the Ethernet port.</p>
<p>Preventa safety controller</p> <p>Serial PC connection cable</p> <p>XPSMCCPC</p> <p>in conjunction with</p> <p>TSXPCX1031</p> <p>The switch must be set to Position 3:</p> <p>OTHER DIRECT.</p>	 <p>OTHER DIRECT.</p>

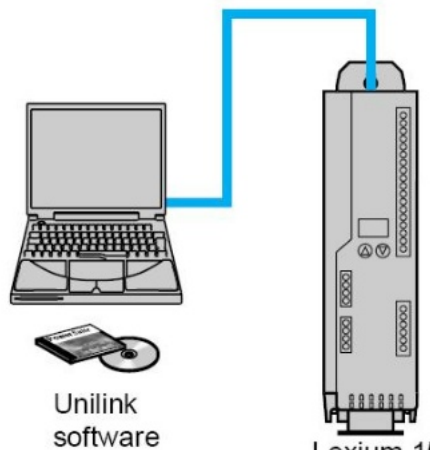
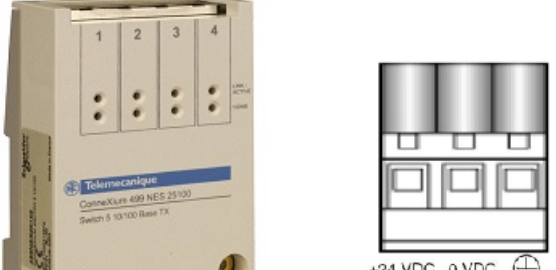
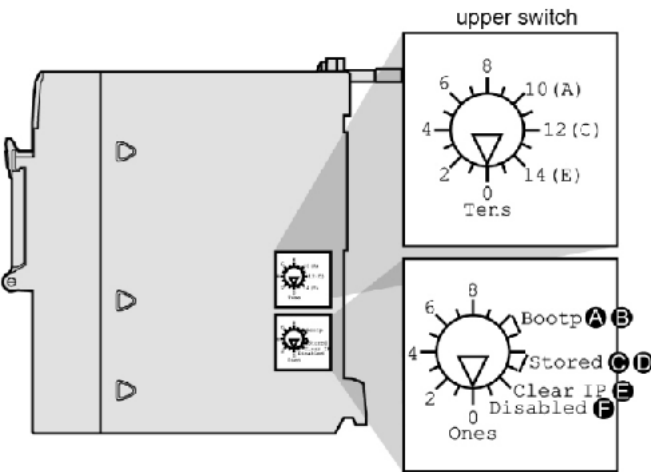

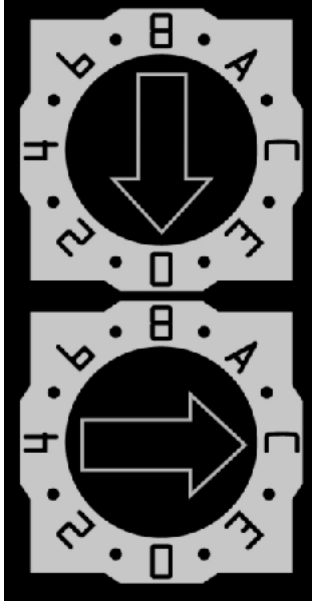
<p>Lexium 15 LP</p> <p>Serial PC connection cable</p> <p>VW3M8601R30</p> <p>For the connection between the PC (with UniLink software) and LXM05 servo drives (-X6A connector).</p>	 <p>Unilink software</p> <p>Lexium 15</p>								
<p>5-port ConneXium Ethernet switch</p> <p>499NES25100</p>	 <table border="1" data-bbox="1069 963 1380 1097"> <thead> <tr> <th>Pin Position</th> <th>Description</th> </tr> </thead> <tbody> <tr> <td>Left</td> <td>+24 VDC</td> </tr> <tr> <td>Center</td> <td>0 VDC</td> </tr> <tr> <td>Right</td> <td>Protective Earth (PE)</td> </tr> </tbody> </table>	Pin Position	Description	Left	+24 VDC	Center	0 VDC	Right	Protective Earth (PE)
Pin Position	Description								
Left	+24 VDC								
Center	0 VDC								
Right	Protective Earth (PE)								
<p>Modicon M340</p> <p>CPU including CANopen and Ethernet</p> <p>BMXP342030</p> <p>Since both rotary switches are located on the rear of the module, assigning the IP address is really easy.</p>	 <p>upper switch</p> <p>lower switch</p>								

<p>For the purpose of this application, the IP address configured (stored) in the Unity project is used.</p> <p>The following settings must also be made on the rotary switches:</p> <p>Upper: 0 In this operating mode, the switch is not evaluated.</p> <p>Lower: C or D Use the configured (stored) IP address</p>		<table border="1"> <tr> <td>Upper Switch</td> </tr> <tr> <td>0 to 9: Tens value for the device name (0, 10, 20 . . . 90)</td> </tr> <tr> <td>10(A) to 15(F): Tens value for the device name (100, 110, 120 . . . 150)</td> </tr> </table> <table border="1"> <tr> <td>Lower Switch</td> </tr> <tr> <td>0 to 9: Ones value for the device name (0, 1, 2 . . . 9)</td> </tr> <tr> <td>Bootp: Set the switch to A or B to receive an IP address from a BOOTP server.</td> </tr> <tr> <td>Stored: Set the switch to C or D to use the application's configured (stored) parameters.</td> </tr> <tr> <td>Clear IP: Set the switch to E to use the default IP parameters.</td> </tr> <tr> <td>Disabled: Set the switch to F to disable communications.</td> </tr> </table>	Upper Switch	0 to 9: Tens value for the device name (0, 10, 20 . . . 90)	10(A) to 15(F): Tens value for the device name (100, 110, 120 . . . 150)	Lower Switch	0 to 9: Ones value for the device name (0, 1, 2 . . . 9)	Bootp: Set the switch to A or B to receive an IP address from a BOOTP server.	Stored: Set the switch to C or D to use the application's configured (stored) parameters.	Clear IP: Set the switch to E to use the default IP parameters.	Disabled: Set the switch to F to disable communications.
Upper Switch											
0 to 9: Tens value for the device name (0, 10, 20 . . . 90)											
10(A) to 15(F): Tens value for the device name (100, 110, 120 . . . 150)											
Lower Switch											
0 to 9: Ones value for the device name (0, 1, 2 . . . 9)											
Bootp: Set the switch to A or B to receive an IP address from a BOOTP server.											
Stored: Set the switch to C or D to use the application's configured (stored) parameters.											
Clear IP: Set the switch to E to use the default IP parameters.											
Disabled: Set the switch to F to disable communications.											
<p>Magelis XBTGT2330</p> <p>Ethernet port for data exchange with the PLC.</p>											
<p>ConneXium Ethernet cable</p> <p>490NTW0000x</p>											

**CANopen
junction box
VW3CANTAP2**

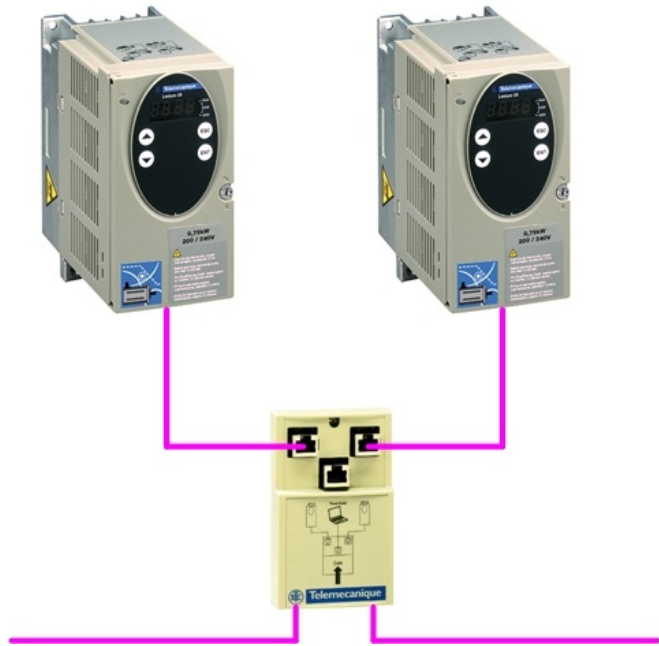

For the purpose of this application, the slide switch must be set to **OFF**.

If, unlike in this application, there is no outgoing CANopen bus, the line terminator must be activated (i.e., the slide switch must be set to ON).

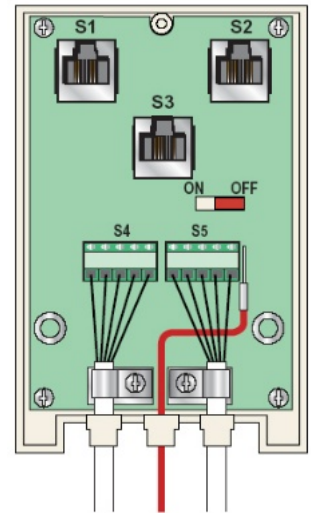
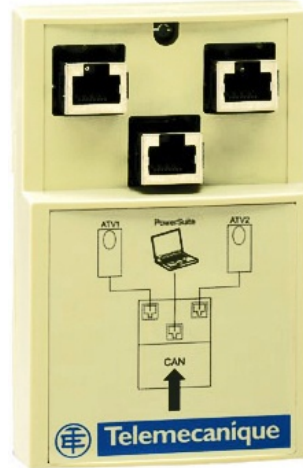

Pin	Signal	Wire colour	Description
1	GND	Black	Ground
2	CAN L	Blue	CAN L bus line
3	SHLD	(bare cables shield)	Optional shield
4	CAN H	White	CAN H bus line
5	(V+)	Red	Optional supply

**CANopen
RJ45 preassembled
connection cable
VW3CANCARRxx**



This cable is used to connect the junction box to the Lexium 05.



VW3CANCARR1
(Length: 1.0 m)

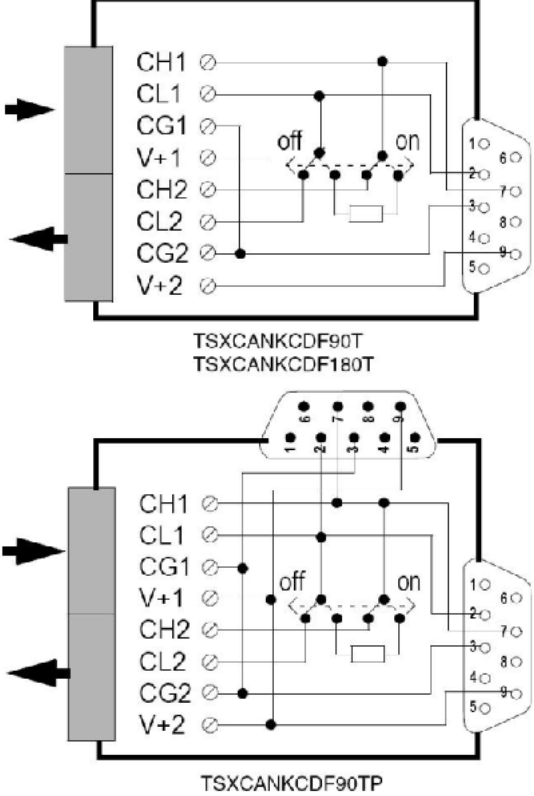

VW3CANCARR03
(Length: 0.3 m)

<p>CANopen connector</p> <p>VW3CANKCDF90T, VW3CANKCDF90TP or VW3CANKCDF180T</p> <p>This connector is used for the link to the CANopen node.</p>																					
<p>The terminating resistor must be activated at the end of the bus. To do this, set the switch to ON.</p> <p>The bus cable must be connected on the incoming side.</p>	 <table border="1" data-bbox="753 1339 1401 1473"> <thead> <tr> <th>Signal</th> <th>Terminal block 1</th> <th>Terminal block 2</th> <th>Wire color</th> </tr> </thead> <tbody> <tr> <td>CAN_H</td> <td>CH1</td> <td>CH2</td> <td>white</td> </tr> <tr> <td>CAN_L</td> <td>CL1</td> <td>CL2</td> <td>blue</td> </tr> <tr> <td>CAN_GND</td> <td>CG1</td> <td>CG2</td> <td>black</td> </tr> <tr> <td>CAN_V+</td> <td>V+1</td> <td>V+2</td> <td>red</td> </tr> </tbody> </table>	Signal	Terminal block 1	Terminal block 2	Wire color	CAN_H	CH1	CH2	white	CAN_L	CL1	CL2	blue	CAN_GND	CG1	CG2	black	CAN_V+	V+1	V+2	red
Signal	Terminal block 1	Terminal block 2	Wire color																		
CAN_H	CH1	CH2	white																		
CAN_L	CL1	CL2	blue																		
CAN_GND	CG1	CG2	black																		
CAN_V+	V+1	V+2	red																		
<p>CANopen cable</p> <p>TCXCANCxyy</p> <p>The cable is available in various versions (x):</p> <p>Standard No Flame Heavy Duty</p> <p>and various lengths (yy):</p> <p>50, 100, 300 m.</p>																					

Lexium 15

UniLink and CANopen adapter

AM02CAN001V000

This adapter is used to separate the RS232 and CANopen signals in respect of connector - **X6**.

This splits up the signals as follows:

- X6A RS232 UniLink
- X6B CANopen

In addition, terminating resistor for CANopen can be activated.

However, this does not need to be carried out for the purpose of this application. Therefore, ensure that the switch is set to **OFF**.

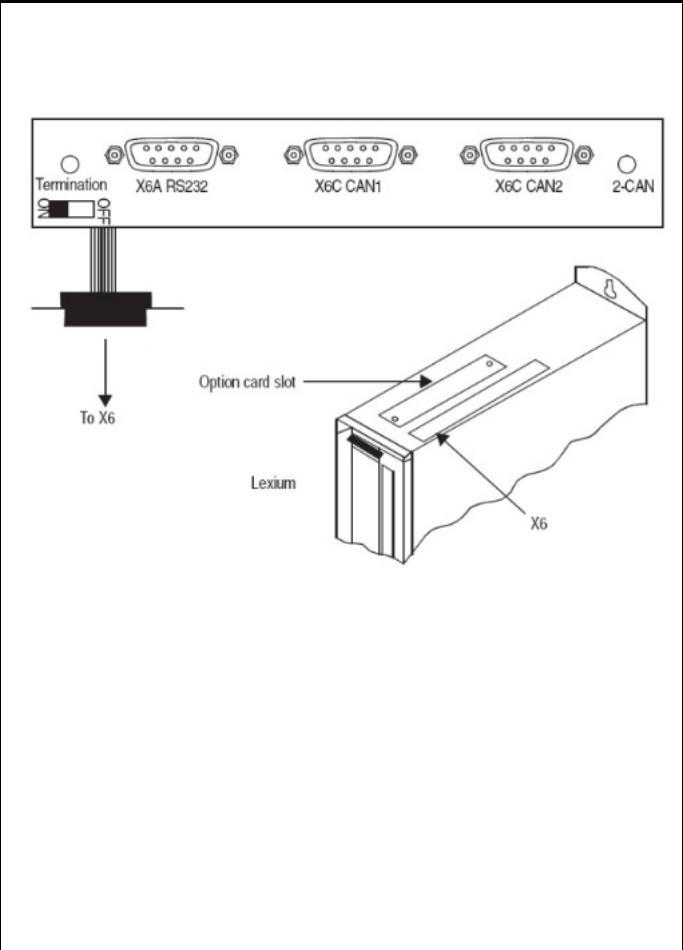

Lexium 05

Modbus and CANopen connector

The CANopen terminating resistor can be activated via switch S1.

However, this does not need to be carried out for the purpose of this application.

Therefore, ensure that the switch is set to **OFF**.

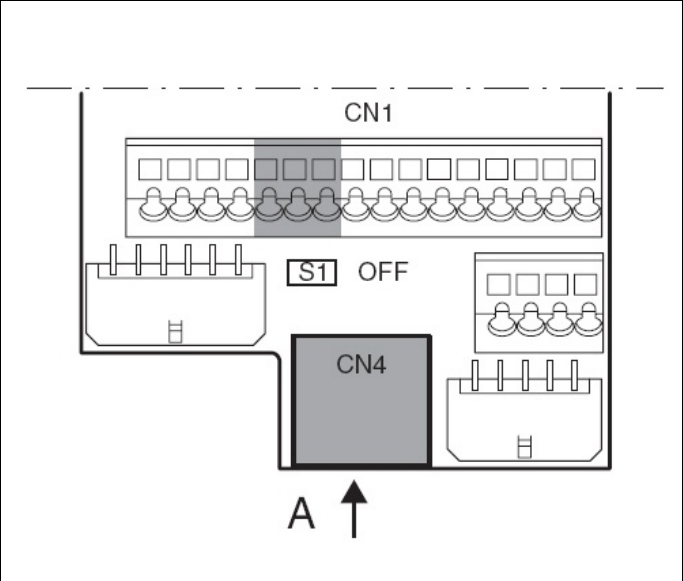

Lexium 05

CANopen connector

The servo drive can be connected to the CANopen bus via terminal CN1.

Pin	Signal	Description
21	CAN_0V	CAN reference potential
22	CAN_L	data wire, inverted
23	CAN_H	data wire

Lexium 05

Modbus and CANopen connector

In this application, the junction box is used to connect the servo drive to the **CANopen** bus via RJ45 socket **CN4**.

The same interface features a Modbus port for establishing a PC and PowerSuite software connection.

A

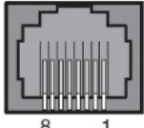

Pin	Signal	Description
1	CAN_H	data wire
2	CAN_L	data wire, inverted
7	MOD+10V_OUT	10V power supply
8	MOD_0V	Reference potential for MOD+10V_OUT

Pin	Signal	Description	
4	MOD_DI	Bidirectional transmit/receive signal	RS485 level
5	MOD_DO	Bidirectional transmit/receive signal, inverted	RS485 level
7	MOD+10V_OUT	10 V power supply, max. 150 mA	Output
8	MOD_0V	Reference potential for MOD+10V_OUT	Output

Altivar 71

CANopen adapter

VW3CANA71

The ATV 71 is connected to the CANopen bus using the above adapter and connector:

VW3CANKCDF180T.

The same interface features a Modbus port for establishing a PC and PowerSuite software connection.

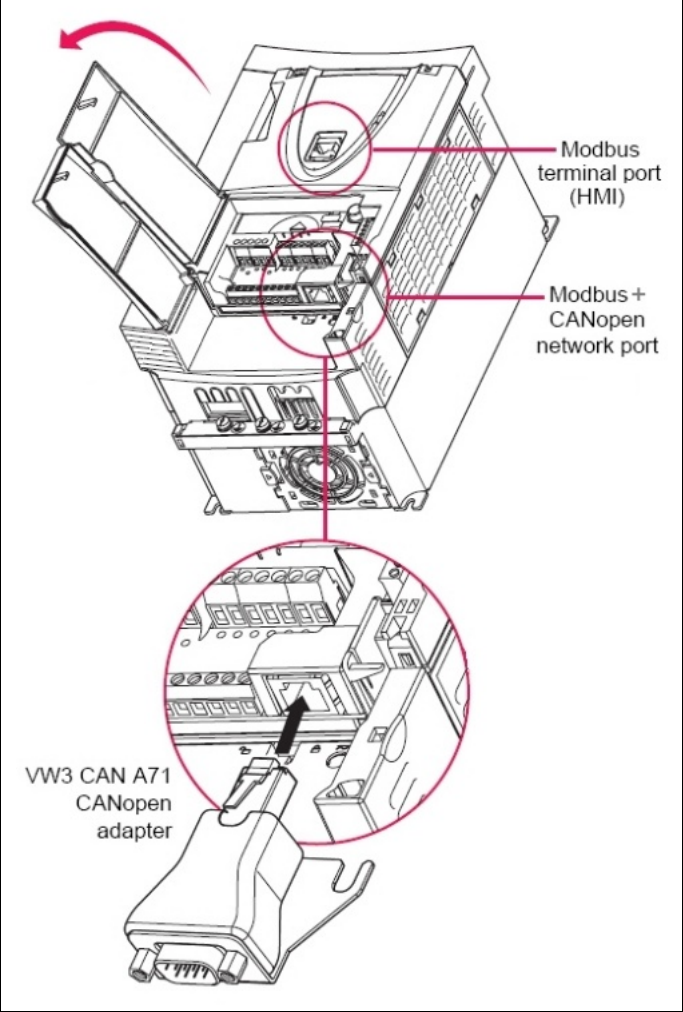

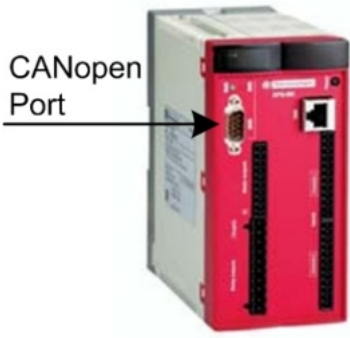
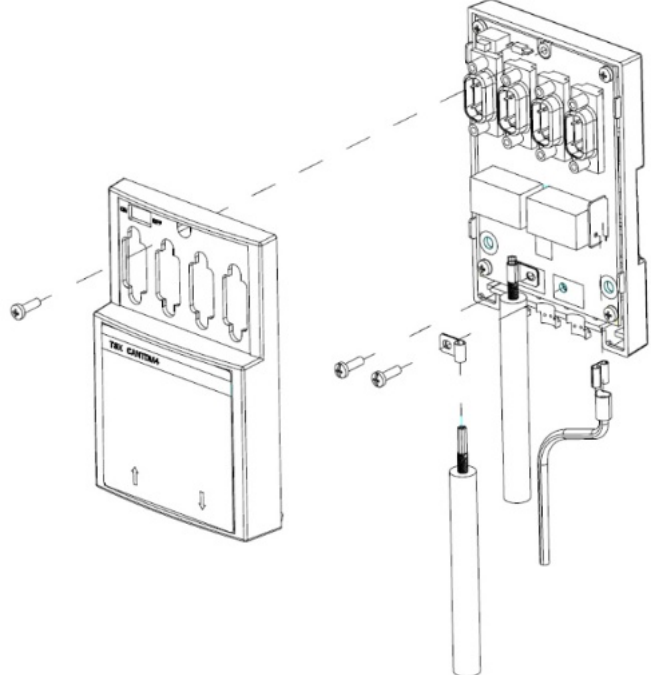
<p style="text-align: center;">Preventa safety controller</p> <p>The safety controller is connected to the CANopen bus using connector</p> <p>VW3CANKCDF90T.</p>	 <p style="text-align: center;">CANopen Port</p>
<p style="text-align: center;">CANopen junction box</p> <p style="text-align: center;">T5XCANTDM4</p> <p>This junction box is placed in front of the TeSysU motor starters so that the 24 V DC power supply can be fed to the communication modules.</p> <p>For the purpose of this application, the sliding switch should be set to OFF.</p> <p>The power supply requires max. 1.5 amp fuse.</p>	

**CANopen
junction box**

TSXCANTDM4

The two TeSysU motor starters are connected to the outgoing CANopen bus.

Power supply:

V+1 24 V DC
CG1 0 V DC

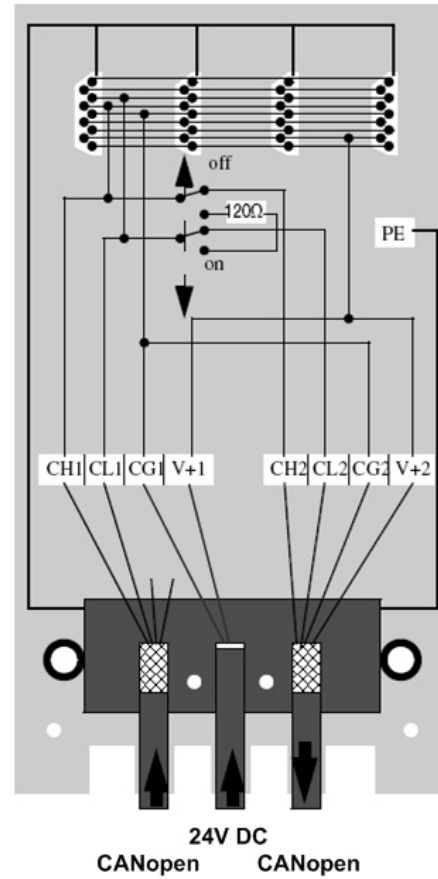

Signal	Terminal block 1	Terminal block 2	Wire color
CAN_H	CH1	CH2	white
CAN_L	CL1	CL2	blue
CAN_GND	CG1	CG2	black
CAN_V+	V+1	V+2	red

**TeSysU CANopen
communication
module**

LULC08

The communication module is connected to the CANopen bus using connector

VW3CANKCDF180T.

In the case of the first connector, the terminating resistor is set to **OFF** and, in the case of the second (the last bus node), it is set to **ON**.

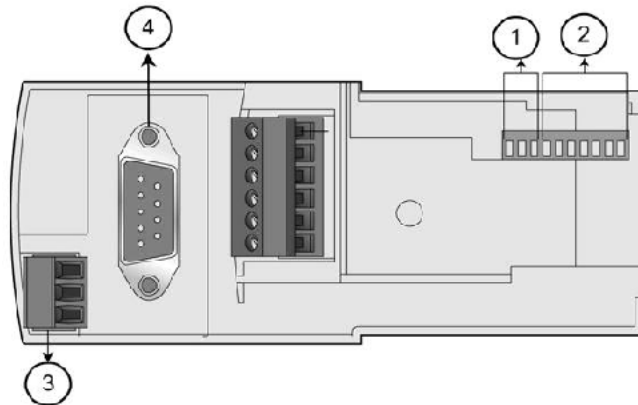

- 1 Baud rate
- 2 Address
- 3 Power base connector
- 4 CAN bus connector

TeSysU CANopen communication module

LULC08

The baud rate is set to **500 kbps**.

The following addresses are used:

1. TeSysU: 17
2. TeSysU: 18

Example:

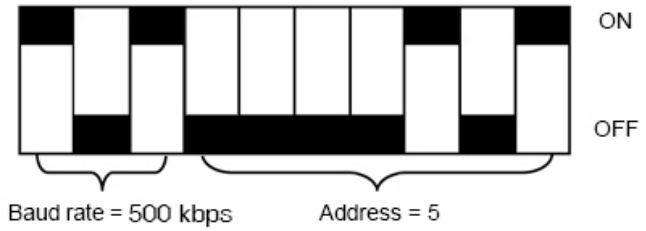

SW10	SW9	SW8	Baud Rate
0	0	0	10 kbps
0	0	1	20 kbps
0	1	0	50 kbps
0	1	1	125 kbps
1	0	0	250 kbps (default)
1	0	1	500 kbps
1	1	0	800 kbps
1	1	1	1,000 kbps

SW7	SW6	SW5	SW4	SW3	SW2	SW1	Address
0	0	0	0	0	0	0	Not valid
0	0	0	0	0	0	1	1 (default)
0	0	0	0	0	1	0	2
0	0	0	0	0	1	1	3
0	0	0	0	1	0	0	4
0	0	0	0	1	0	1	5
...							
1	1	1	1	1	1	1	127

Implementation

Introduction

The implementation chapter describes all the steps necessary to initialise, to configure, to program and start-up the system to achieve the application functions as listed below.

Here is an overview of the individual sub-sections:

- **Function**
A short description of the operating procedures
- **Communication**
The settings, memory areas and variable names used for communication are described here.
- **PLC**
Describes how to configure the PLC with Unity.
- **HMI**
Instructions for creating the HMI application.
- **Devices**
Procedure for parameterizing the devices used, such as the safety controller, Lexium, Altivar, and TeSysU.

Function

Instructions for switching on and functional description

1. Switch on the master switch.
2. Switch on all fuses and motor circuit breakers.
3. Acknowledge Emergency Off signals.
4. Wait until all CANopen nodes are on the network.
5. The relevant nodes can be selected and controlled on the HMI. This is only intended for manual operation.

Functional Layout

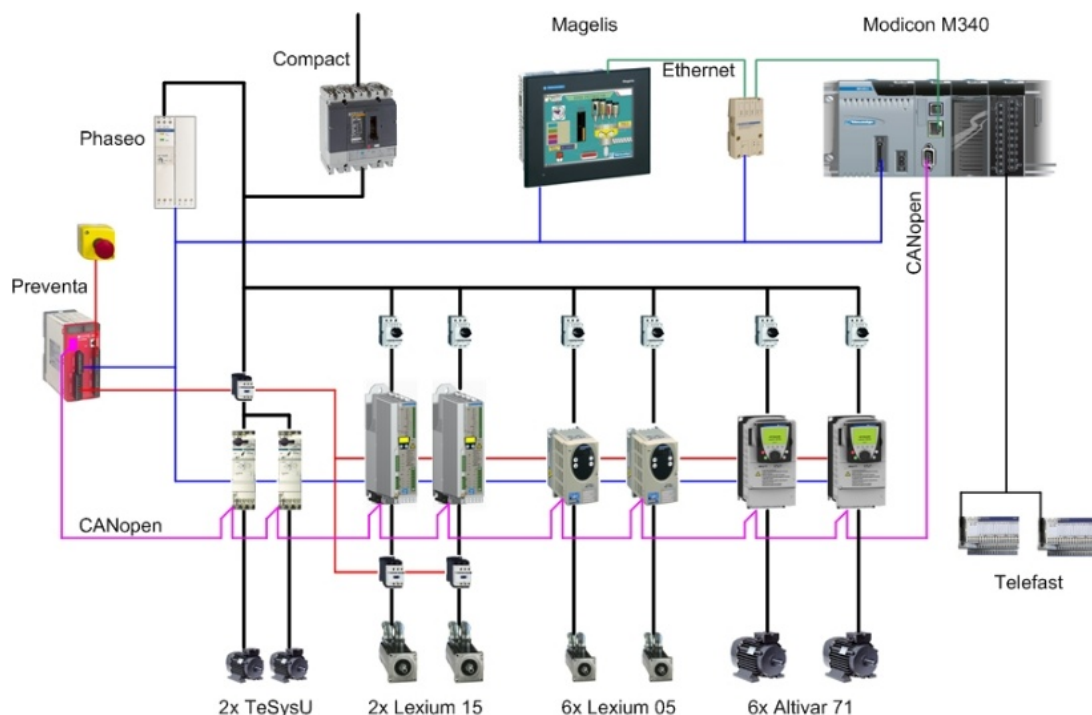

Communication

Introduction

This chapter describes the data passed via the communications bus (e.g. Modbus Plus or TCP/IP) that is not bound directly with digital or analog hardware.

The list contains:

- The device links
 - Direction of data flow
 - symbolic name and
 - Bus address of the device concerned.
-

Device Links

The CANopen and TCP/IP bus systems are used in this application.

The devices below are networked via **CANopen**:

- One Modicon M340 PLC as the bus master, bus address 127
- One Preventa safety controller, bus address 2
- Six Lexium 05 servo drives, bus addresses 3 - 8
- Two Lexium 15 servo drives, bus addresses 9 - 10
- Six Altivar 71 variable speed drives, bus addresses 11 to 16
- Two TeSysU motor starters, bus addresses 17 and 18

Two devices are interconnected via **TCP/IP**, along with a PC that has Unity and Vijeo Designer software installed on it for configuration purposes.

- Modicon M340 PLC, bus address 192.168.100.41
 - Magelis XBTGT HMI, bus address 192.168.100.47
-

CANopen

On the CANopen network, you can connect up to **63 slaves** (addresses 1 – 63) and one bus master to the bus.

Bus lengths, segments and junctions all have restrictions, which are outlined in the tables below.

The data throughput rate selected for the bus determines the maximum length of the entire network:

Baud rate	Maximum length
1 Mbps	4 m
500 kbps	100 m
250 kbps	250 m
125 kbps	500 m
50 kbps	1000 m
20 kbps	2500 m

Note: Number of PDOs supported:

- 256 receiving (RxPDO)
- 256 transmitting (TxPDO)

The following **CANopen settings** are used in this application:

- A baud rate of **500 kbps** and
- A **200 ms heartbeat** monitoring the nodes

CANopen
 - Address
 - COB-ID
 - direction

Data Direction PLC ← Device (TPDO)										
Device	Adr.	via *)	COB_ID with PDO							
			1.	2.	3.	4.	5.	6.	7.	8.
Safety	2	PDO					680	681	382	683
1. LXM05	3	MFB	183			483				
2. LXM05	4	MFB	184			484				
3. LXM05	5	MFB	185			485				
4. LXM05	6	MFB	186			486				
5. LXM05	7	MFB	187			487				
6. LXM05	8	MFB	188			488				
1. LXM15	9	MFB	189	289						
2. LXM15	10	MFB	18A	28A						
1. ATV71	11	MFB	18B							
2. ATV71	12	MFB	18C							
3. ATV71	13	MFB	18D							
4. ATV71	14	MFB	18E							
5. ATV71	15	MFB	18F							
6. ATV71	16	MFB	190							
1. TeSysU	17	PDO	191			491				
2. TeSysU	18	PDO	192			492				

Data Direction PLC → Device (RPDO)										
Device	Adr.	via *)	COB_ID with PDO							
			1.	2.	3.	4.	5.	6.	7.	8.
Safety	2	PDO								
1. LXM05	3	MFB	203							
2. LXM05	4	MFB	204							
3. LXM05	5	MFB	205							
4. LXM05	6	MFB	206							
5. LXM05	7	MFB	207							
6. LXM05	8	MFB	208							
1. LXM15	9	MFB	209	309	409					
2. LXM15	10	MFB	20A	30A	40A					
1. ATV71	11	MFB	20B							
2. ATV71	12	MFB	20C							
3. ATV71	13	MFB	20D							
4. ATV71	14	MFB	20E							
5. ATV71	15	MFB	20F							
6. ATV71	16	MFB	210							
1. TeSysU	17	PDO	211			511				
2. TeSysU	18	PDO	212			512				

*) PDO: Process data objects are objects that represent the communication interface for process data and enable real-time data exchange.
 MFB: Motion Function Blocks use CANopen for straightforward access to basic servo drive functions.

CANopen

Übertragungseinstellungen

Device	Direction	PDO	Transmission Type	Inhibit time [x100µs]	Event time [ms]
Safety	Send	PDO 5	255	0	0
Safety	Send	PDO 6	255	0	0
Safety	Send	PDO 7	255	0	0
Safety	Send	PDO 8	255	0	0
LXM05	Send	PDO 1	255	50	0
LXM05	Send	PDO 4	255	200	0
LXM05	Receive	PDO 1	255	---	---
LXM15LP	Send	PDO 1	255	20	0
LXM15LP	Send	PDO 2	255	10	0
LXM15LP	Receive	PDO 1	255	---	---
LXM15LP	Receive	PDO 2	255	---	---
LXM15LP	Receive	PDO 3	255	---	---
ATV71	Send	PDO 1	255	300	1000
ATV71	Receive	PDO 1	255	---	---
TeSysU	Send	PDO 1	255	0	0
TeSysU	Send	PDO 4	255	0	0
TeSysU	Receive	PDO 4	255	---	---

Transmission type:

- Synchronous, acyclic: Transmission type **0** means that the message is to be transmitted in synchronism with the SYNC message, but not cyclically.
- Synchronous, cyclic: A value between **1** and **240** means that the PDO is transmitted synchronously and cyclically. The transmission type value provides the number of SYNC messages between two PDO transmissions.
- Asynchronous PDO: Transmission type **254** means that the PDO is transmitted asynchronously. This type is completely dependent on how it is implemented in the device, and is mainly used for digital I/O.
- Synchronous PDO: Transmission type **255** means that the PDO will be transmitted asynchronously as soon as the value changes.

Ensure that the configured transmission type is supported by the selected device.

Inhibit time

- The time during which no PDOs can be sent. 0 signifies that this has been deactivated.

Event timer

- The time during which at least one PDO is sent. 0 signifies that this has been deactivated.

CANopen
Datalink
PLC <> Safety

Modicon M340 (CANopen-Bus-Master)		Safety (CANopen-Slave)	
Data Direction PLC ← Safety			
Address	Name	Index	Designation
%IW\3.2\0.0.0.0	XPS_Status	2000:00	Status Byte
%IW\3.2\0.0.0.1	XPS_Mode	2001:00	Mode Byte
%IW\3.2\0.0.0.4	XPS_Input_09_15	2004:00	Input data state 9-15
%IW\3.2\0.0.0.5	XPS_Input_01_08	2005:00	Input data state 1-8
%IW\3.2\0.0.0.8	XPS_Output_01_08	2008:00	Output data state 1-8
%IW\3.2\0.0.0.10	XPS_ErrIn_09_15	200A:00	Input error 9-15
%IW\3.2\0.0.0.11	XPS_ErrIn_01_08	200B:00	Input error 1-8
%IW\3.2\0.0.0.14	XPS_ErrOut_01_08	200E:00	Output error 1-8
%IW\3.2\0.0.0.16	XPS_Diag_1_A	2010:00	Diag info 1 low
%IW\3.2\0.0.0.17	XPS_Diag_1_B	2011:00	Diag info 1 high
%IW\3.2\0.0.0.18	XPS_Diag_1_Msg	2012:00	Diag message 1
%IW\3.2\0.0.0.20	XPS_Diag_2_A	2014:00	Diag info 2 low
%IW\3.2\0.0.0.21	XPS_Diag_2_B	2015:00	Diag info 2 high
%IW\3.2\0.0.0.22	XPS_Diag_2_Msg	2016:00	Diag message 2
%IW\3.2\0.0.0.24	XPS_Diag_3_A	2018:00	Diag info 3 low
%IW\3.2\0.0.0.25	XPS_Diag_3_B	2019:00	Diag info 3 high
%IW\3.2\0.0.0.26	XPS_Diag_3_Msg	201A:00	Diag message 3
Data direction PLC → Safety			
Address	Name	Index	Designation
---	---	---	---

CANopen
Data Links
PLC <> LXM05

Modicon M340 (CANopen-Bus-Master)		Lexium 05 (CANopen-Slave)	
Data Direction PLC ← Lexium 05			
Address	Name	Index	Designation
%ID\3.x\0.0.0.0	---	301B:07	PLCopenTX1
%ID\3.x\0.0.0.2	---	301B:08	PLCopen Tx2
%ID\3.x\0.0.0.4	---	6064:00	Position actual value
%ID\3.x\0.0.0.6	---	606C:00	Velocity actual value
Datenrichtung SPS → Lexium 05			
Address	Name	Index	Designation
%QD\3.x\0.0.0.0	---	301B:05	PLCopen Rx1
%QD\3.x\0.0.0.2	---	301B:06	PLCopen Rx2

\3.x\ - x stands for the CANopen address of the first to the sixth Lexium 05 drive.
x can range from 3 to 8.

**CANopen
Data Link
PLC <> LXM15**

Modicon M340 (CANopen-Bus-Master)		Lexium 15 LP (CANopen-Slave)	
Data direction PLC ← Lexium 15 LP			
Address	Name	Index	Designation
%ID\3.x\0.0.0.0	---	6064:00	Position actual value
%ID\3.x\0.0.0.2	---	606C:00	Velocity actual value
%IW\3.x\0.0.0.5	---	6041:00	Statusword
%IW\3.x\0.0.0.6	---	6061:00	Modes actual
%IW\3.x\0.0.0.4	---	2088:00	Trajectory status
Data direction PLC → Lexium 15 LP			
Address	Name	Index	Designation
%QW\3.x\0.0.0.6	---	2080:00	Motion task
%QD\3.x\0.0.0.4	---	60FF:00	Target velocity
%QD\3.x\0.0.0.0	---	607A:00	Target position
%QD\3.x\0.0.0.2	---	6081:00	Profil velocity
%QW\3.x\0.0.0.7	---	6040:00	Controlword
%QW\3.x\0.0.0.8	---	6060:00	Modes set

\3.x\ - x stands for the CANopen address of the first and second Lexium 15 LP drives.

x can be either **9** or **10**.

**CANopen
Data Link
PLC <> ATV71**

Modicon M340 (CANopen-Bus-Master)		Altivar 71 (CANopen-Slave)	
Data direction PLC ← Altivar 71			
Address	Name	Index	Designation
%IW\3.x\0.0.0.0	---	6041:00	Statusword
%IW\3.x\0.0.0.1	---	6044:00	Control effort
Datenrichtung SPS → Altivar 71			
Address	Name	Index	Designation
%QW\3.x\0.0.0.0	---	6040:00	Controlword
%QW\3.x\0.0.0.1	---	6042:00	Target velocity

\3.x\ - x stands for the CANopen address of the first to the sixth Altivar 71.

x can range from **11** to **16**.

**CANopen
Data Links
PLC <> TeSysU**

Modicon M340 (CANopen-Bus-Master)		TeSysU (CANopen-Slave)	
Data Direction SPS ← TeSysU			
Address	Name	Index	Designation
%IW\3.x\0.0.0.6	TeSysU_y_Status	2004:06	Status register
%IW\3.x\0.0.0.9	TeSysU_y_IOstatus	2004:09	I/O module status register
%IW\3.x\0.0.0.11	TeSysU_y_Warning	2004:0C	Warning register
%ID\3.x\0.0.0.0	---	3000:03	PKW: Response object
%ID\3.x\0.0.0.2	---	3000:04	PKW: Response data
Datenrichtung SPS → TeSysU			
Address	Name	Index	Designation
%QW\3.x\0.0.0.8	TeSysU_y_Control	2008:05	Control of the system
%QW\3.x\0.0.0.7	TeSysU_y_Comm	2008:04	Control of comm module
%QW\3.x\0.0.0.6	TeSysU_y_Output	2008:01	Control of outputs
%QD\3.x\0.0.0.0	---	3000:01	PKW: Request object
%QD\3.x\0.0.0.2	---	3000:02	PKW: Request data

\3.x\ - x stands for the CANopen address of the first and second TeSysU motor starters.

x can be either **17** or **18**.

y - y stands for the first and second TeSysU motor starters.

y can be either **1** or **2**.

**Ethernet
HMI <> PLC**
Address
summary

Data Direction HMI ↔ SPS		
Device	Start address	Reserved Memory
General		%M501...600
Safety		%M601...650
CANopen Safety		%MW401...420 %MW421...430
1. LXM05	%MW500	%MW501...520
2. LXM05	%MW520	%MW521...540
3. LXM05	%MW540	%MW541...560
4. LXM05	%MW560	%MW561...580
5. LXM05	%MW580	%MW581...600
6. LXM05	%MW600	%MW601...620
1. LXM15	%MW620	%MW621...640
2. LXM15	%MW640	%MW641...660
1. ATV71	%MW660	%MW661...680
2. ATV71	%MW680	%MW681...700
3. ATV71	%MW700	%MW701...720
4. ATV71	%MW720	%MW721...740
5. ATV71	%MW740	%MW741...760
6. ATV71	%MW760	%MW761...780
1. TeSysU		%MW781...800
2. TeSysU		%MW801...820

**Ethernet
HMI <> PLC
for Lexium
and Altivar**

Data Direction HMI ↔ PLC (for Lexium and Altivar)						
Name	%MW	Bit	Typ	LXM	ATV	Designation
YY_X_Ready	+1	0	BOOL	x	x	Drive is ready
YY_X_Power	+1	1	BOOL	x	x	Drive power on
YY_X_Start	+1	2	BOOL	x	x	Start drive
YY_X_Dir	+1	3	BOOL	x	x	Direction
YY_X_Mode_VE	+1	4	BOOL	x		Set velocity mode
YY_X_Mode_AB	+1	5	BOOL	x		Set absolute pos. mode
YY_X_Mode_RE	+1	6	BOOL	x		Set relative pos. mode
YY_X_Reset	+1	7	BOOL	x	x	Reset error
YY_X_Velocity	+2		DINT	x	x	Target velocity
YY_X_Position	+4		DINT	x		Target position
YY_X_ACC	+6		UDINT	x		Acceleration
YY_X_DCC	+8		UDINT	x		Deceleration
YY_X_Active	+11	0	BOOL	x	x	Drive is active
YY_X_Disable	+11	1	BOOL	x	x	Drive is disabled
YY_X_Standstill	+11	2	BOOL	x	x	Drive in standstill
YY_X_Stopping	+11	3	BOOL	x	x	Drive in stopping
YY_X_IN_VE	+11	4	BOOL	x	x	Drive in velocity mode
YY_X_IN_AB	+11	5	BOOL	x		Drive in absolute pos mode
YY_X_IN_RE	+11	6	BOOL	x		Drive in relative pos mode
YY_X_in_Velocity	+11	7	BOOL	x	x	Drive reached velocity
YY_X_in_Position	+11	8	BOOL	x		Drive reached position
YY_X_Error	+11	9	BOOL	x	x	Error
YY_X_Act_Position	+12		DINT	x		Position actual value
YY_X_Act_Velocity	+14		DINT	x	x	Velocity actual value
YY_X_ErrorID	+16		UDINT	x	x	Error ID code
YY_X_ErrorMA	+18		INT	x	x	Error message code

YY - YY stands for the drive type.

YY can be either **LXM05, LXM15 or ATV71**.

X - X represents the specific drive number for a particular type.

X can range from **1 to 6**.

The address is made up of the start address (mentioned above) + %MW + bit. In the case of the third Lexium 05 for the direction, the address is:

%MW540 + 1 + bit = %MW541.3

**Ethernet
HMI <> PLC
for TeSysU**

Data Direction HMI ↔ PLC (für TeSysU)				
Name	1. TeSysU	2. TeSysU	Typ	Designation
YY_X_HMI_Ready	%MW781.0	%MW801.0	BOOL	Power is ON
YY_X_HMI_Run	%MW781.1	%MW801.1	BOOL	Pole status is closed
YY_X_HMI_Trip	%MW781.2	%MW801.2	BOOL	Tripped position
YY_X_HMI_Error	%MW781.3	%MW801.3	BOOL	Fault or warning
YY_X_HMI_Start	%MW782.0	%MW802.0	BOOL	Run forward
YY_X_HMI_Reset	%MW782.1	%MW802.1	BOOL	Reset fault and warning

YY - YY stands for the drive type.

YY can be **TeSysU**.

X - X represents the specific drive number for a particular type.

X can be either **1 or 2**.

General Addressing

PLC and HMI

<p>Various hardware addresses, as well as flags and flag words, are used in the PLC/HMI application. An overview of the addresses used is provided below. The "Address" column shows how the address is written and the potential ranges within the example application.</p>		
Type	Address	Comment
Digital inputs	%I _{r.m.x} -r: 0 -m: 1 - 3 -x: 0...31	PLC: Digital inputs are specified on a hardware basis: r indicates the rack number, m the slot and x the input number.
Digital outputs	%Q _{r.m.x} -r: 0 -m: 3 - 4 -x: 0...31	PLC: Digital outputs are specified on a hardware basis: r indicates the rack number, m the slot and x the output number.
Analog inputs	%IW _{r.m.c} -r: 0 -m: 5 -c: 0...3	PLC: Analog inputs are specified on a hardware basis: r indicates the rack number, m the slot and c the channel number.
Analog outputs	%QW _{r.m.c} -r: 0 -m: 6 -c: 0...2	PLC: Analog outputs are specified on a hardware basis: r indicates the rack number, m the slot and c the channel number.
Flag words	%MW _x -x Word	PLC and HMI: Flag words are used for data exchange between the PLC and HMI. The range depends on the settings in the PLC. Maximum: 32463; 0 - 9999 are used
Flags	%M _x -x Word	PLC and HMI: Flags are used for data exchange between the PLC and HMI. The range depends on the settings in the PLC. Maximum: 32633; 0 - 9999 are used
Derived flags	%MW _{x.y} %MW _{x:Xy} -x Word -y Bit	PLC and HMI: The elements (bits) from the flag words are used for data exchange between the PLC and HMI. The range depends on the settings in the PLC. Maximum: 32633; 0 – 9999 used; Bits 0 - 15. Various PLC notations. %MW100.1 Bit 1 from MW100 HMI %MW102:X1 Bit 1 from MW100
CANopen status	%CH _{r.m.c} -r: 0 -m: 0 -c: 2	PLC: Status data for CANopen is read via data structure T_COM_CO_BMX (IODDT). Channel address: r indicates the rack number, m the slot and c the channel number. CANopen status %CH0.0.2

PLC

Introduction

The PLC chapter describes the steps required for the initialization and configuration and the source program required to fulfill the functions.

Pre-Conditions

Before carrying out the steps described below, you must ensure the following:

- The Unity Pro programming software is installed on your PC.
- The Modicon M340 PLC is connected to the power supply.
- The PLC and the PC are connected to one another via the programming cable (**BMXXCAUSB0xx**) or Ethernet (with a known IP address).

Setting up the PLC is done as follows:

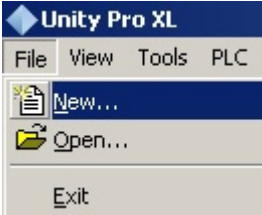
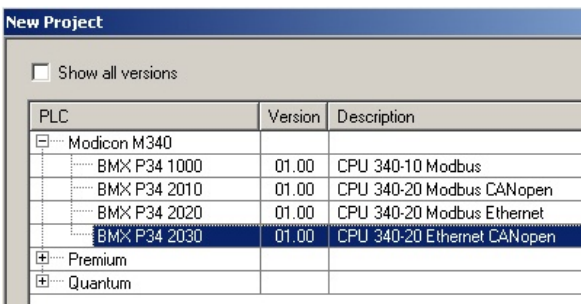
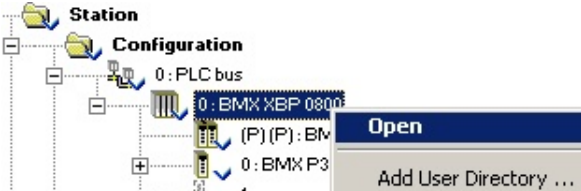

- Create a new program and select hardware.
- Parameterize the communication.
- Create new variables.
- Add CANopen nodes.
- Parameterize CANopen PDO.
- Set up axes for the drives.
- Program assignment.
- MFB - Motion Function Block.
- Create and use DFB.
- Required blocks.
- Create a new operator screen.
- Build project.
- Connect PC to PLC and transfer project.
- Export and archive project.

Creating a New Program and Selecting Hardware

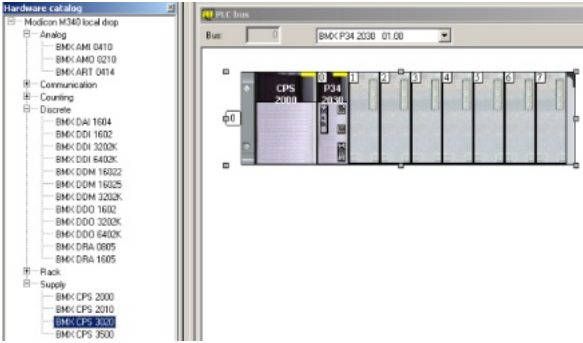
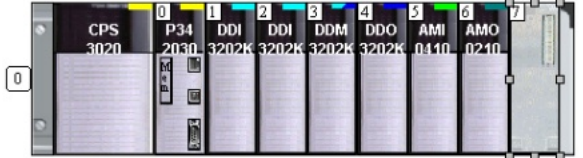
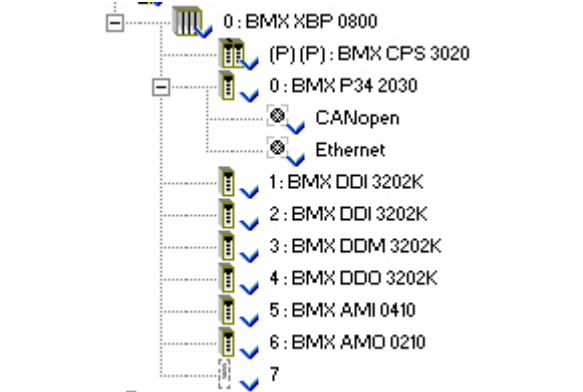
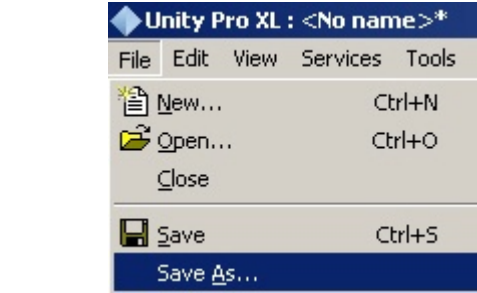

1	To create a new program, select New from the File menu.	
2	<p>A window opens where you can select the CPU to be used.</p> <p>For this application, select the Modicon M340 CPU</p> <p>BMX P34 2030</p> <p>and click OK to confirm.</p> <p>This will load the default settings.</p>	
3	Double-click the rack in the project browser or right-click and select Open .	

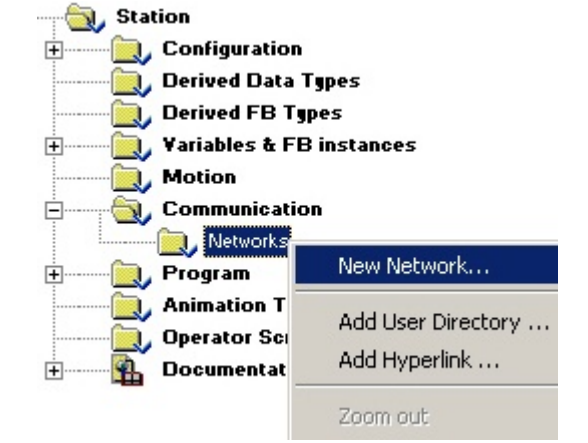
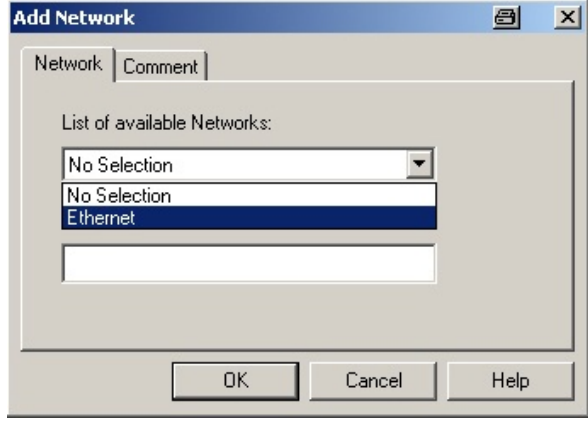
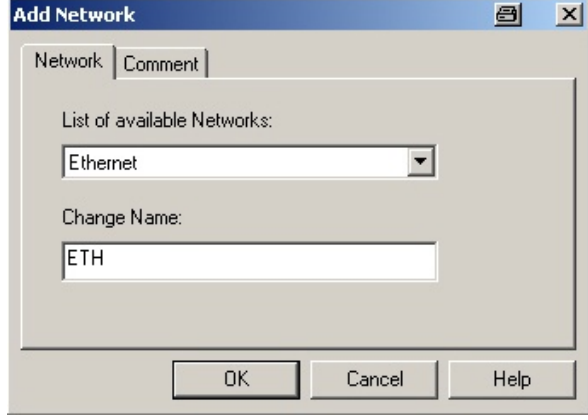
<p>4</p>	<p>This will open the rack and the Hardware catalog. To equip the rack, simply select the individual components and drag and drop them to the empty slots.</p> <p>The following hardware is used:</p> <table border="0"> <tr> <td>Rack</td> <td>BMX XBP 0800</td> </tr> <tr> <td>Power</td> <td>BMX CPS 3020</td> </tr> <tr> <td>CPU</td> <td>BMX P34 2030</td> </tr> <tr> <td>32DI</td> <td>BMX DDI 3202K</td> </tr> <tr> <td>32DI</td> <td>BMX DDI 3202K</td> </tr> <tr> <td>16DI/16DO</td> <td>BMX DDM 3202K</td> </tr> <tr> <td>32DO</td> <td>BMX DDO 3202K</td> </tr> <tr> <td>4AI</td> <td>BMX AMI 0410</td> </tr> <tr> <td>2AO</td> <td>BMX AMO 0210</td> </tr> </table>	Rack	BMX XBP 0800	Power	BMX CPS 3020	CPU	BMX P34 2030	32DI	BMX DDI 3202K	32DI	BMX DDI 3202K	16DI/16DO	BMX DDM 3202K	32DO	BMX DDO 3202K	4AI	BMX AMI 0410	2AO	BMX AMO 0210	
Rack	BMX XBP 0800																			
Power	BMX CPS 3020																			
CPU	BMX P34 2030																			
32DI	BMX DDI 3202K																			
32DI	BMX DDI 3202K																			
16DI/16DO	BMX DDM 3202K																			
32DO	BMX DDO 3202K																			
4AI	BMX AMI 0410																			
2AO	BMX AMO 0210																			
<p>5</p>	<p>The display shown opposite will appear.</p>																			
<p>6</p>	<p>This is what the display looks like as a tree structure in the project browser.</p>																			
<p>7</p>	<p>At this point, it is recommended that you save the project.</p> <p>To do this, select</p> <p>Save As...</p> <p>in the File menu.</p> <p>You can then select the File name (<File name>.stu) and the location where the file is to be saved under Save in.</p> <p>Click OK to exit.</p>																			

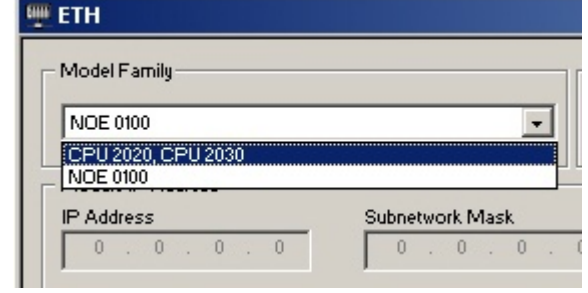
Parameterizing the Communication

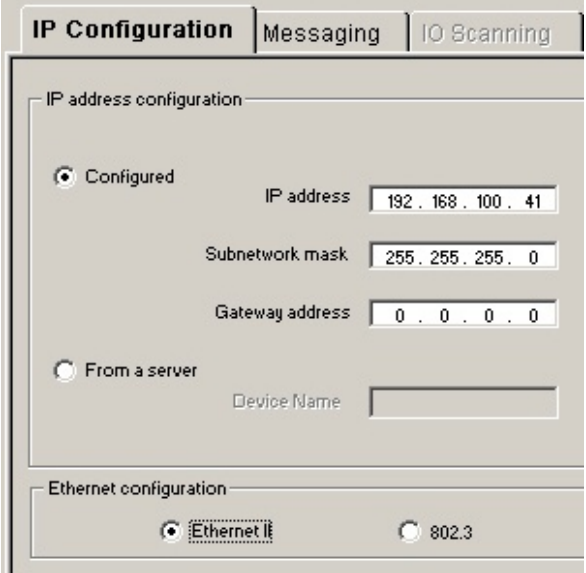
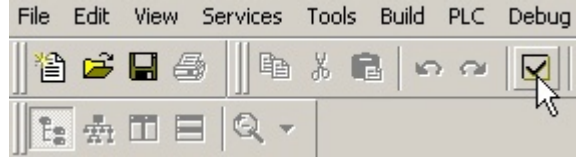
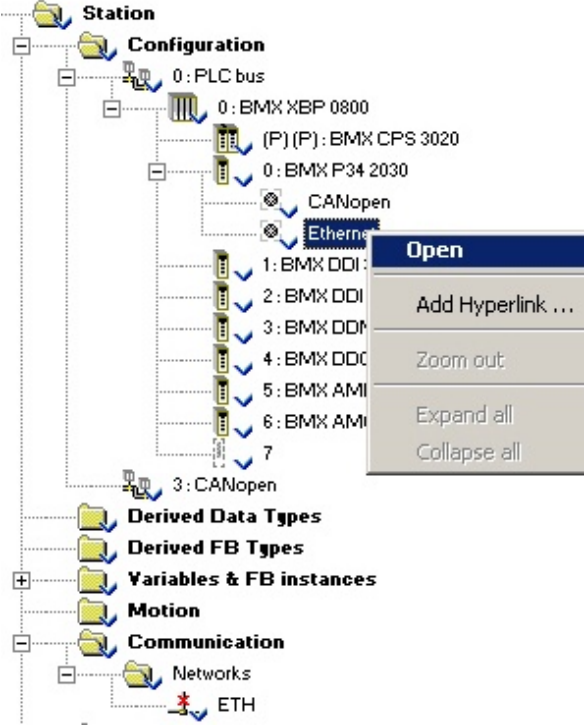
<p>1</p>	<p>Ethernet and CANopen interfaces are used in this application.</p> <p>For Ethernet, the first thing you need to do is create a new network.</p> <p>To do this, right-click Networks in the Communication directory and select New Network...</p>	
<p>2</p>	<p>Select Ethernet from the list of networks in the window that appears.</p>	
<p>3</p>	<p>A name must also be entered. You are free to choose any name, but in this example, ETH is used.</p> <p>Click OK to confirm.</p>	
<p>4</p>	<p>Open the parameterization window by right-clicking ETH and selecting Open.</p>	
<p>5</p>	<p>First, select CPU 2030 under Model Family.</p>	

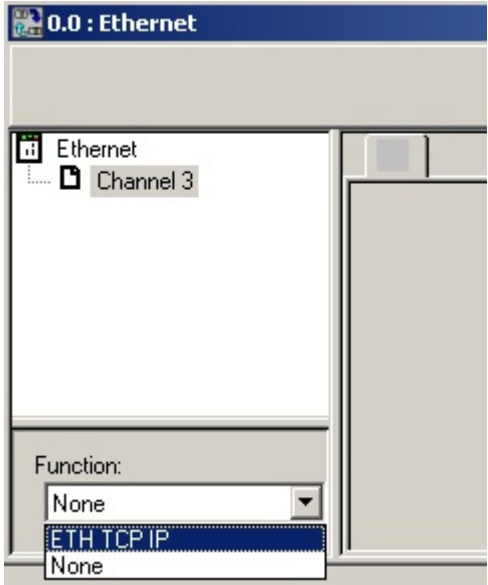
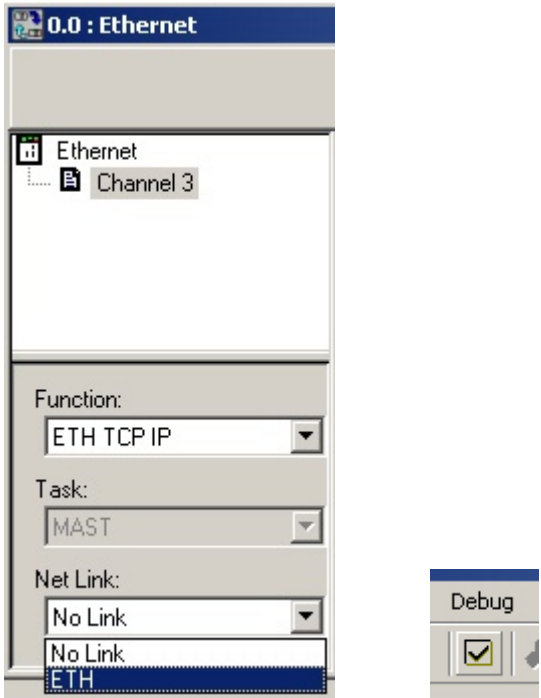

6	<p>Click Yes to confirm the prompt that appears.</p>	
7	<p>Enter the IP address used on the IP Configuration tab. In this application, the following address is used:</p> <p style="text-align: center;">192.168.100.41 255.255.255.0</p> <p>The HMI uses this address for data exchange, and Unity Pro uses it to connect to the PLC.</p> <p>Note: To be able to use this IP address, the rotary switch on the rear of the CPU must be set to the stored IP address. See Communication for further details.</p>	
8	<p>The entries must then be validated.</p> <p>To do this, click the Tick icon in the toolbar.</p>	
9	<p>Under Communication and Networks, a red cross indicates that the network is not assigned to any hardware.</p> <p>The Ethernet interface is available on the CPU being used here.</p> <p>Right-click on Ethernet and select Open to assign the CPU.</p>	

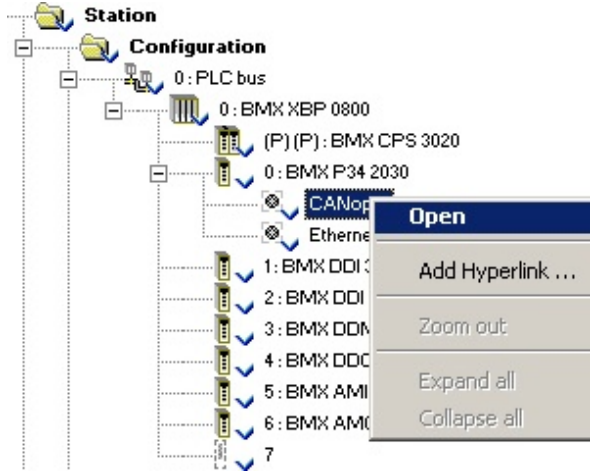
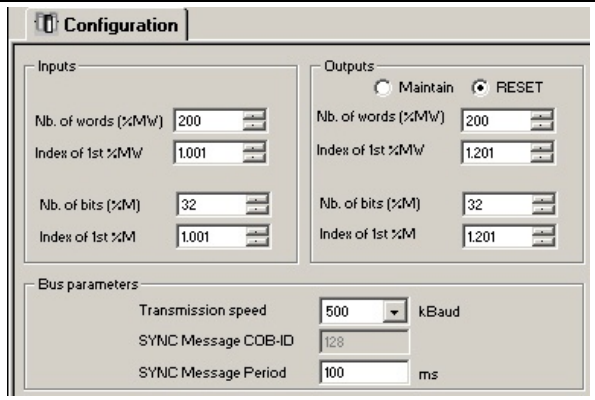
10	<p>Under Function, select:</p> <p>ETH_TCP_IP.</p>	
11	<p>Then, under Net Link, assign the communication network ETH that was created previously.</p> <p>Finally, validate these entries as well.</p>	
12	<p>The red cross under Networks has now disappeared.</p>	

<p>13</p>	<p>To access the CANopen configuration, right-click CANopen in the project browser and select:</p> <p>Open.</p>	
<p>14</p>	<p>A Transmission speed (baud rate) of 500 kBaud is used.</p> <p>Additionally, 200 words are reserved for both Inputs and Outputs. The indices of the 1st %MWs are 1001 (Input) and 1201 (Output) respectively.</p> <p>32 bits are reserved for each of the flags.</p>	
<p>15</p>	<p>Once the application is closed, selecting Build will display the number of flags and words that are actually required.</p>	<p>The configuration needs 179 %MW IN. The configuration needs 147 %MW OUT. The configuration needs 0 %M IN. The configuration needs 0 %M OUT.</p>

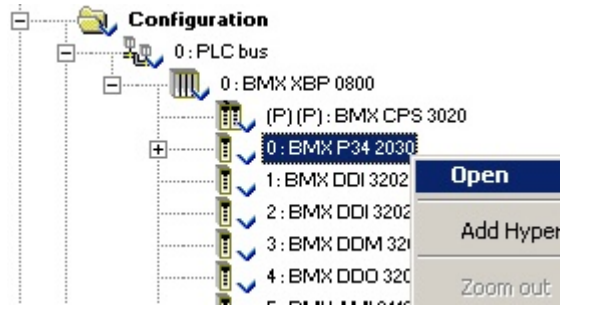
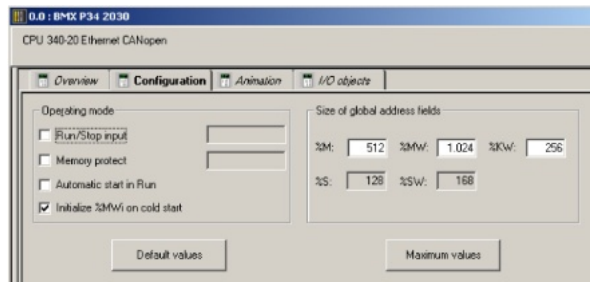
Creating New Variables

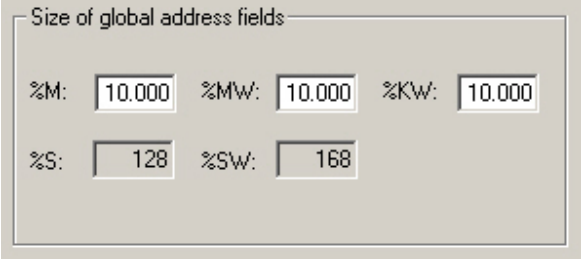
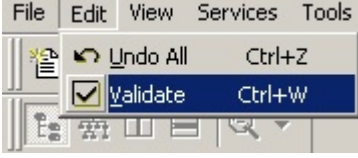
<p>1</p>	<p>Addresses must be assigned to the variables for the purpose of data exchange with the HMI.</p> <p>The size of the addresses can be adjusted.</p> <p>To do this, right-click the CPU and select Open.</p>	
<p>2</p>	<p>The CPU properties appear.</p>	

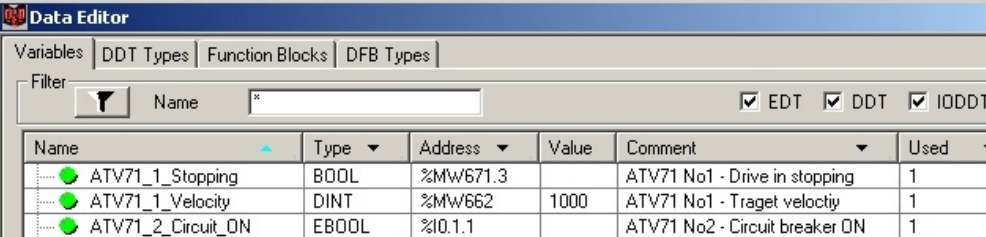
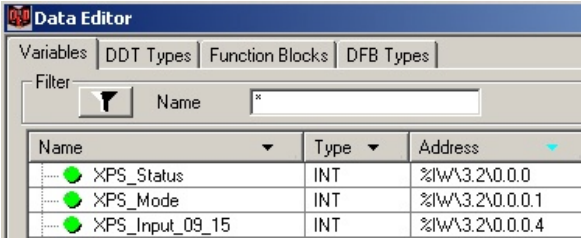
3	<p>For this application, enter the following sizes for the individual global address fields:</p> <p>%M 10000 %MW 10000 %KW 10000</p>	
4	<p>Select Validate under Edit to validate the entries. Alternatively, you can click the icon on the toolbar.</p>	
5	<p>Open the Data Editor by right-clicking</p> <p>Variables & FB instances</p> <p>and selecting</p> <p>Open.</p>	
6	<p>You can enter all variables in the Data Editor. To do this, enter the variable name in the Name column and the variable type in the Type column. An initial value can be set in the Value column.</p> <p>To address the variables (located variables), an address must be entered in the Address column. The following addresses appear on the partial screenshot below:</p> <p>%MW671.3 Bit 3 in word 671 %MW662 Flag word 662 %IO.1.1 Digital input from rack 0; card 1 of input 1.</p>	
7		
8	<p>Here is an address for a CANopen node:</p> <p>%IW\3.3\0.0.0 or %IW\3.3\0.0.0.1 %IW Input word \3.3\ Card 3 (CANopen) CANopen address 3 0.0.0 1st word (also 0.0.0.0) 0.0.0.1 2nd word</p>	

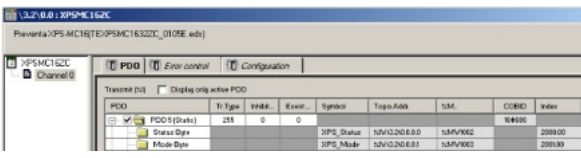
<p>9</p>	<p>Once entered in the Data Editor, the variable name relating to the CANopen node is displayed in the Symbol column of the PDO tab.</p> <p>Please consult the documentation for other address types.</p>																									
<p>10</p>	<table border="1" data-bbox="526 492 1372 627"> <thead> <tr> <th>PDO</th> <th>Tr.Type</th> <th>Inhibit...</th> <th>Event ...</th> <th>Symbol</th> <th>Topo.Addr.</th> </tr> </thead> <tbody> <tr> <td>[-] [x] [Folder] PDO 5 (Static)</td> <td>255</td> <td>0</td> <td>0</td> <td></td> <td></td> </tr> <tr> <td> [-] [Folder] Status Byte</td> <td></td> <td></td> <td></td> <td>XPS_Status</td> <td>%Iw13.2\0.0.0.0</td> </tr> <tr> <td> [-] [Folder] Mode Byte</td> <td></td> <td></td> <td></td> <td>XPS_Mode</td> <td>%Iw13.2\0.0.0.1</td> </tr> </tbody> </table>	PDO	Tr.Type	Inhibit...	Event ...	Symbol	Topo.Addr.	[-] [x] [Folder] PDO 5 (Static)	255	0	0			[-] [Folder] Status Byte				XPS_Status	%Iw13.2\0.0.0.0	[-] [Folder] Mode Byte				XPS_Mode	%Iw13.2\0.0.0.1	
PDO	Tr.Type	Inhibit...	Event ...	Symbol	Topo.Addr.																					
[-] [x] [Folder] PDO 5 (Static)	255	0	0																							
[-] [Folder] Status Byte				XPS_Status	%Iw13.2\0.0.0.0																					
[-] [Folder] Mode Byte				XPS_Mode	%Iw13.2\0.0.0.1																					

Adding CANopen Nodes

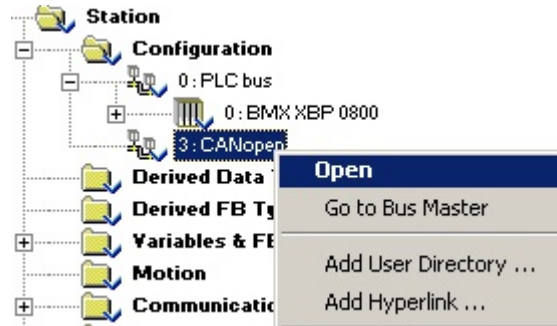
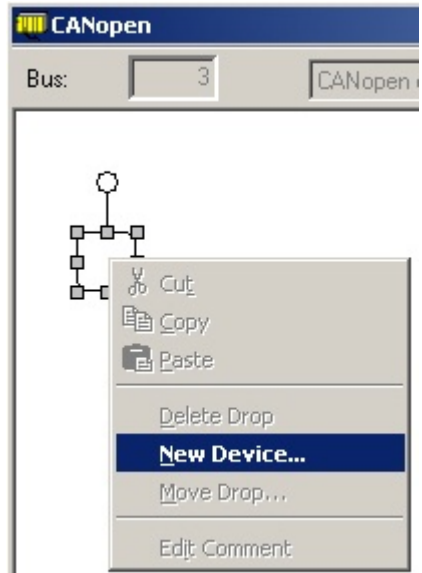
<p>1</p>	<p>The CANopen bus window can be used to add up to 63 CANopen nodes.</p> <p>To do this, select CANopen in the project browser and Open from the pop-up menu.</p>	
<p>2</p>	<p>The CANopen window appears.</p> <p>Click the empty field and select New Device from the menu.</p>	

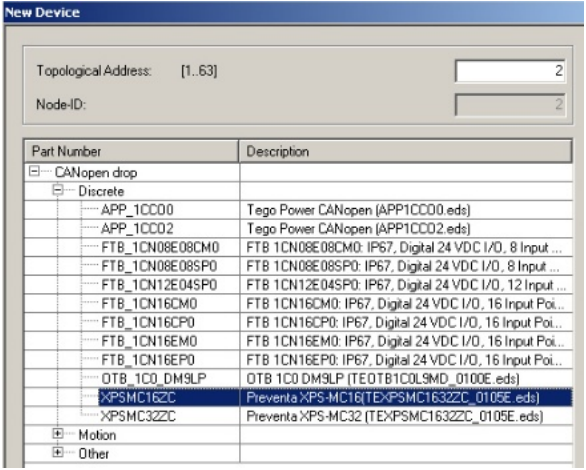
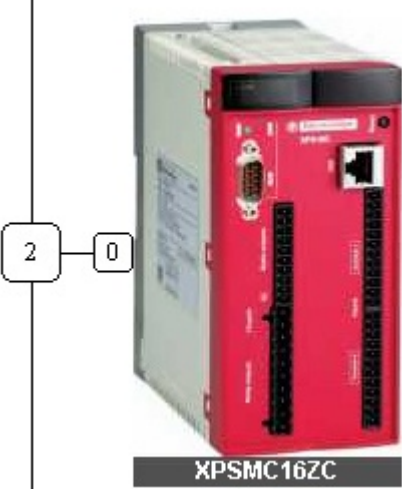
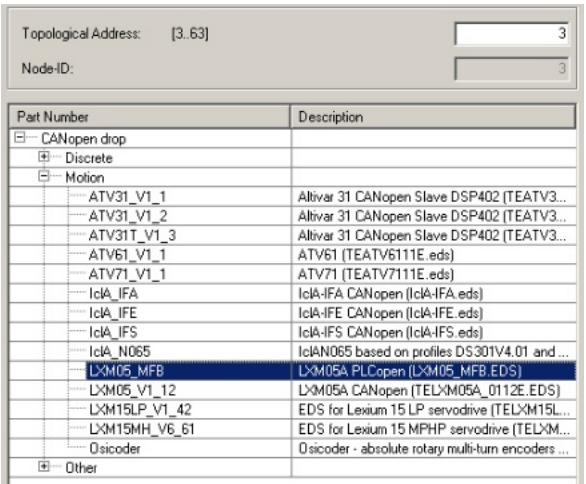

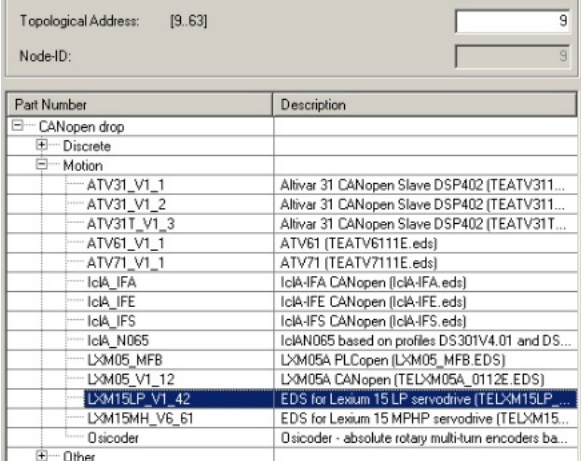
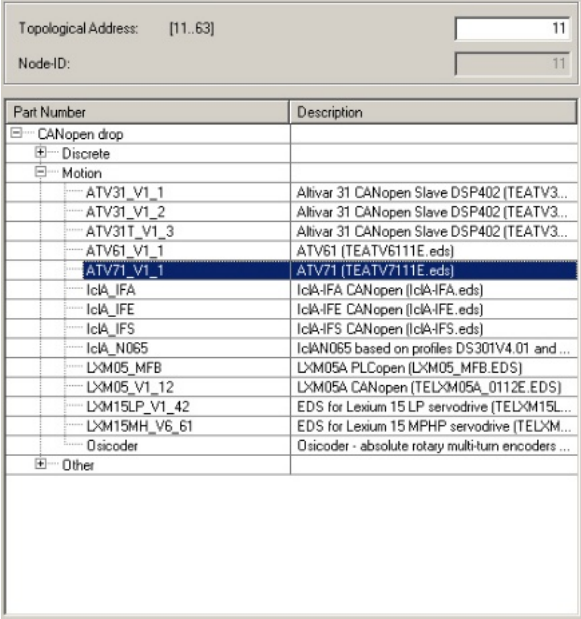
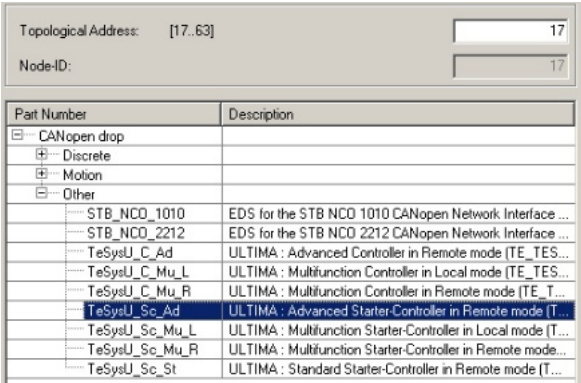
<p>3</p>	<p>Add the safety controller as the first node.</p> <p>Enter the CANopen address 2 in the Topological Address field.</p> <p>As Part Number, select the device XPSMC16ZC under Discrete and click OK to confirm.</p>	
<p>4</p>	<p>The device with its CANopen address is now displayed.</p> <p>Click New Device in the next field, as described above.</p>	 <p style="text-align: center;">XPSMC16ZC</p>
<p>5</p>	<p>Since the six Lexium 05 CANopen nodes are being controlled by MFB (Motion Function Block), you must select LXM05_MFB under Motion.</p> <p>Enter a value between 3 and 8 for the Topological Address.</p>	

<p>6</p>	<p>For the two Lexium 15 LPs, select LXM15LP_V1_42 under Motion.</p> <p>Enter either 9 or 10 for the Topological Address.</p>	 <p>Topological Address: [9..63] <input type="text" value="9"/></p> <p>Node-ID: <input type="text" value="9"/></p> <table border="1"> <thead> <tr> <th>Part Number</th> <th>Description</th> </tr> </thead> <tbody> <tr><td>[-] CANopen drop</td><td></td></tr> <tr><td>[-] Discrete</td><td></td></tr> <tr><td>[-] Motion</td><td></td></tr> <tr><td> ATV31_V1_1</td><td>Altivar 31 CANopen Slave DSP402 (TEATV311E.eds)</td></tr> <tr><td> ATV31_V1_2</td><td>Altivar 31 CANopen Slave DSP402 (TEATV311E.eds)</td></tr> <tr><td> ATV31T_V1_3</td><td>Altivar 31 CANopen Slave DSP402 (TEATV311E.eds)</td></tr> <tr><td> ATV61_V1_1</td><td>ATV61 (TEATV6111E.eds)</td></tr> <tr><td> ATV71_V1_1</td><td>ATV71 (TEATV7111E.eds)</td></tr> <tr><td> IcA_IFA</td><td>IcA-IFA CANopen (IcA-IFA.eds)</td></tr> <tr><td> IcA_IFE</td><td>IcA-IFE CANopen (IcA-IFE.eds)</td></tr> <tr><td> IcA_IFS</td><td>IcA-IFS CANopen (IcA-IFS.eds)</td></tr> <tr><td> IcA_N065</td><td>IcAN065 based on profiles DS301V4.01 and DS301V4.02</td></tr> <tr><td> LXM05_MFB</td><td>LXM05A PLCopen (LXM05_MFB.EDS)</td></tr> <tr><td> LXM05_V1_12</td><td>LXM05A CANopen (TELXM05A_0112E.EDS)</td></tr> <tr><td> LXM15LP_V1_42</td><td>EDS for Lexium 15 LP servodrive (TELXM15LP_V1_42.EDS)</td></tr> <tr><td> LXM15MH_V6_61</td><td>EDS for Lexium 15 MPHP servodrive (TELXM15MH_V6_61.EDS)</td></tr> <tr><td> Oscoder</td><td>Oscoder - absolute rotary multi-turn encoders based on DS301V4.01 and DS301V4.02</td></tr> <tr><td>[-] Other</td><td></td></tr> </tbody> </table>	Part Number	Description	[-] CANopen drop		[-] Discrete		[-] Motion		ATV31_V1_1	Altivar 31 CANopen Slave DSP402 (TEATV311E.eds)	ATV31_V1_2	Altivar 31 CANopen Slave DSP402 (TEATV311E.eds)	ATV31T_V1_3	Altivar 31 CANopen Slave DSP402 (TEATV311E.eds)	ATV61_V1_1	ATV61 (TEATV6111E.eds)	ATV71_V1_1	ATV71 (TEATV7111E.eds)	IcA_IFA	IcA-IFA CANopen (IcA-IFA.eds)	IcA_IFE	IcA-IFE CANopen (IcA-IFE.eds)	IcA_IFS	IcA-IFS CANopen (IcA-IFS.eds)	IcA_N065	IcAN065 based on profiles DS301V4.01 and DS301V4.02	LXM05_MFB	LXM05A PLCopen (LXM05_MFB.EDS)	LXM05_V1_12	LXM05A CANopen (TELXM05A_0112E.EDS)	LXM15LP_V1_42	EDS for Lexium 15 LP servodrive (TELXM15LP_V1_42.EDS)	LXM15MH_V6_61	EDS for Lexium 15 MPHP servodrive (TELXM15MH_V6_61.EDS)	Oscoder	Oscoder - absolute rotary multi-turn encoders based on DS301V4.01 and DS301V4.02	[-] Other	
Part Number	Description																																							
[-] CANopen drop																																								
[-] Discrete																																								
[-] Motion																																								
ATV31_V1_1	Altivar 31 CANopen Slave DSP402 (TEATV311E.eds)																																							
ATV31_V1_2	Altivar 31 CANopen Slave DSP402 (TEATV311E.eds)																																							
ATV31T_V1_3	Altivar 31 CANopen Slave DSP402 (TEATV311E.eds)																																							
ATV61_V1_1	ATV61 (TEATV6111E.eds)																																							
ATV71_V1_1	ATV71 (TEATV7111E.eds)																																							
IcA_IFA	IcA-IFA CANopen (IcA-IFA.eds)																																							
IcA_IFE	IcA-IFE CANopen (IcA-IFE.eds)																																							
IcA_IFS	IcA-IFS CANopen (IcA-IFS.eds)																																							
IcA_N065	IcAN065 based on profiles DS301V4.01 and DS301V4.02																																							
LXM05_MFB	LXM05A PLCopen (LXM05_MFB.EDS)																																							
LXM05_V1_12	LXM05A CANopen (TELXM05A_0112E.EDS)																																							
LXM15LP_V1_42	EDS for Lexium 15 LP servodrive (TELXM15LP_V1_42.EDS)																																							
LXM15MH_V6_61	EDS for Lexium 15 MPHP servodrive (TELXM15MH_V6_61.EDS)																																							
Oscoder	Oscoder - absolute rotary multi-turn encoders based on DS301V4.01 and DS301V4.02																																							
[-] Other																																								
<p>7</p>	<p>For the six Altivar 71 drives, select ATV71_V1_1 under Motion.</p> <p>Enter a value between 11 and 16 for the Address.</p>	 <p>Topological Address: [11..63] <input type="text" value="11"/></p> <p>Node-ID: <input type="text" value="11"/></p> <table border="1"> <thead> <tr> <th>Part Number</th> <th>Description</th> </tr> </thead> <tbody> <tr><td>[-] CANopen drop</td><td></td></tr> <tr><td>[-] Discrete</td><td></td></tr> <tr><td>[-] Motion</td><td></td></tr> <tr><td> ATV31_V1_1</td><td>Altivar 31 CANopen Slave DSP402 (TEATV311E.eds)</td></tr> <tr><td> ATV31_V1_2</td><td>Altivar 31 CANopen Slave DSP402 (TEATV311E.eds)</td></tr> <tr><td> ATV31T_V1_3</td><td>Altivar 31 CANopen Slave DSP402 (TEATV311E.eds)</td></tr> <tr><td> ATV61_V1_1</td><td>ATV61 (TEATV6111E.eds)</td></tr> <tr><td> ATV71_V1_1</td><td>ATV71 (TEATV7111E.eds)</td></tr> <tr><td> IcA_IFA</td><td>IcA-IFA CANopen (IcA-IFA.eds)</td></tr> <tr><td> IcA_IFE</td><td>IcA-IFE CANopen (IcA-IFE.eds)</td></tr> <tr><td> IcA_IFS</td><td>IcA-IFS CANopen (IcA-IFS.eds)</td></tr> <tr><td> IcA_N065</td><td>IcAN065 based on profiles DS301V4.01 and DS301V4.02</td></tr> <tr><td> LXM05_MFB</td><td>LXM05A PLCopen (LXM05_MFB.EDS)</td></tr> <tr><td> LXM05_V1_12</td><td>LXM05A CANopen (TELXM05A_0112E.EDS)</td></tr> <tr><td> LXM15LP_V1_42</td><td>EDS for Lexium 15 LP servodrive (TELXM15LP_V1_42.EDS)</td></tr> <tr><td> LXM15MH_V6_61</td><td>EDS for Lexium 15 MPHP servodrive (TELXM15MH_V6_61.EDS)</td></tr> <tr><td> Oscoder</td><td>Oscoder - absolute rotary multi-turn encoders based on DS301V4.01 and DS301V4.02</td></tr> <tr><td>[-] Other</td><td></td></tr> </tbody> </table>	Part Number	Description	[-] CANopen drop		[-] Discrete		[-] Motion		ATV31_V1_1	Altivar 31 CANopen Slave DSP402 (TEATV311E.eds)	ATV31_V1_2	Altivar 31 CANopen Slave DSP402 (TEATV311E.eds)	ATV31T_V1_3	Altivar 31 CANopen Slave DSP402 (TEATV311E.eds)	ATV61_V1_1	ATV61 (TEATV6111E.eds)	ATV71_V1_1	ATV71 (TEATV7111E.eds)	IcA_IFA	IcA-IFA CANopen (IcA-IFA.eds)	IcA_IFE	IcA-IFE CANopen (IcA-IFE.eds)	IcA_IFS	IcA-IFS CANopen (IcA-IFS.eds)	IcA_N065	IcAN065 based on profiles DS301V4.01 and DS301V4.02	LXM05_MFB	LXM05A PLCopen (LXM05_MFB.EDS)	LXM05_V1_12	LXM05A CANopen (TELXM05A_0112E.EDS)	LXM15LP_V1_42	EDS for Lexium 15 LP servodrive (TELXM15LP_V1_42.EDS)	LXM15MH_V6_61	EDS for Lexium 15 MPHP servodrive (TELXM15MH_V6_61.EDS)	Oscoder	Oscoder - absolute rotary multi-turn encoders based on DS301V4.01 and DS301V4.02	[-] Other	
Part Number	Description																																							
[-] CANopen drop																																								
[-] Discrete																																								
[-] Motion																																								
ATV31_V1_1	Altivar 31 CANopen Slave DSP402 (TEATV311E.eds)																																							
ATV31_V1_2	Altivar 31 CANopen Slave DSP402 (TEATV311E.eds)																																							
ATV31T_V1_3	Altivar 31 CANopen Slave DSP402 (TEATV311E.eds)																																							
ATV61_V1_1	ATV61 (TEATV6111E.eds)																																							
ATV71_V1_1	ATV71 (TEATV7111E.eds)																																							
IcA_IFA	IcA-IFA CANopen (IcA-IFA.eds)																																							
IcA_IFE	IcA-IFE CANopen (IcA-IFE.eds)																																							
IcA_IFS	IcA-IFS CANopen (IcA-IFS.eds)																																							
IcA_N065	IcAN065 based on profiles DS301V4.01 and DS301V4.02																																							
LXM05_MFB	LXM05A PLCopen (LXM05_MFB.EDS)																																							
LXM05_V1_12	LXM05A CANopen (TELXM05A_0112E.EDS)																																							
LXM15LP_V1_42	EDS for Lexium 15 LP servodrive (TELXM15LP_V1_42.EDS)																																							
LXM15MH_V6_61	EDS for Lexium 15 MPHP servodrive (TELXM15MH_V6_61.EDS)																																							
Oscoder	Oscoder - absolute rotary multi-turn encoders based on DS301V4.01 and DS301V4.02																																							
[-] Other																																								
<p>8</p>	<p>The two TeSysU devices are the last of the CANopen nodes.</p> <p>In this case, select TeSysU_Sc_Ad under Other. This represents a TeSysU StarterController (sc) with an advanced (Ad = Advanced) trip unit.</p> <p>Enter either 17 or 18 for the Address.</p>	 <p>Topological Address: [17..63] <input type="text" value="17"/></p> <p>Node-ID: <input type="text" value="17"/></p> <table border="1"> <thead> <tr> <th>Part Number</th> <th>Description</th> </tr> </thead> <tbody> <tr><td>[-] CANopen drop</td><td></td></tr> <tr><td>[-] Discrete</td><td></td></tr> <tr><td>[-] Motion</td><td></td></tr> <tr><td>[-] Other</td><td></td></tr> <tr><td> STB_NCO_1010</td><td>EDS for the STB NCO 1010 CANopen Network Interface (STB_NCO_1010.EDS)</td></tr> <tr><td> STB_NCO_2212</td><td>EDS for the STB NCO 2212 CANopen Network Interface (STB_NCO_2212.EDS)</td></tr> <tr><td> TeSysU_C_Ad</td><td>ULTIMA : Advanced Controller in Remote mode (TE_TES_U_C_Ad.EDS)</td></tr> <tr><td> TeSysU_C_Mu_L</td><td>ULTIMA : Multifunction Controller in Local mode (TE_TES_U_C_Mu_L.EDS)</td></tr> <tr><td> TeSysU_C_Mu_R</td><td>ULTIMA : Multifunction Controller in Remote mode (TE_TES_U_C_Mu_R.EDS)</td></tr> <tr><td> TeSysU_Sc_Ad</td><td>ULTIMA : Advanced Starter-Controller in Remote mode (TE_TES_U_Sc_Ad.EDS)</td></tr> <tr><td> TeSysU_Sc_Mu_L</td><td>ULTIMA : Multifunction Starter-Controller in Local mode (TE_TES_U_Sc_Mu_L.EDS)</td></tr> <tr><td> TeSysU_Sc_Mu_R</td><td>ULTIMA : Multifunction Starter-Controller in Remote mode (TE_TES_U_Sc_Mu_R.EDS)</td></tr> <tr><td> TeSysU_Sc_St</td><td>ULTIMA : Standard Starter-Controller in Remote mode (TE_TES_U_Sc_St.EDS)</td></tr> </tbody> </table>	Part Number	Description	[-] CANopen drop		[-] Discrete		[-] Motion		[-] Other		STB_NCO_1010	EDS for the STB NCO 1010 CANopen Network Interface (STB_NCO_1010.EDS)	STB_NCO_2212	EDS for the STB NCO 2212 CANopen Network Interface (STB_NCO_2212.EDS)	TeSysU_C_Ad	ULTIMA : Advanced Controller in Remote mode (TE_TES_U_C_Ad.EDS)	TeSysU_C_Mu_L	ULTIMA : Multifunction Controller in Local mode (TE_TES_U_C_Mu_L.EDS)	TeSysU_C_Mu_R	ULTIMA : Multifunction Controller in Remote mode (TE_TES_U_C_Mu_R.EDS)	TeSysU_Sc_Ad	ULTIMA : Advanced Starter-Controller in Remote mode (TE_TES_U_Sc_Ad.EDS)	TeSysU_Sc_Mu_L	ULTIMA : Multifunction Starter-Controller in Local mode (TE_TES_U_Sc_Mu_L.EDS)	TeSysU_Sc_Mu_R	ULTIMA : Multifunction Starter-Controller in Remote mode (TE_TES_U_Sc_Mu_R.EDS)	TeSysU_Sc_St	ULTIMA : Standard Starter-Controller in Remote mode (TE_TES_U_Sc_St.EDS)										
Part Number	Description																																							
[-] CANopen drop																																								
[-] Discrete																																								
[-] Motion																																								
[-] Other																																								
STB_NCO_1010	EDS for the STB NCO 1010 CANopen Network Interface (STB_NCO_1010.EDS)																																							
STB_NCO_2212	EDS for the STB NCO 2212 CANopen Network Interface (STB_NCO_2212.EDS)																																							
TeSysU_C_Ad	ULTIMA : Advanced Controller in Remote mode (TE_TES_U_C_Ad.EDS)																																							
TeSysU_C_Mu_L	ULTIMA : Multifunction Controller in Local mode (TE_TES_U_C_Mu_L.EDS)																																							
TeSysU_C_Mu_R	ULTIMA : Multifunction Controller in Remote mode (TE_TES_U_C_Mu_R.EDS)																																							
TeSysU_Sc_Ad	ULTIMA : Advanced Starter-Controller in Remote mode (TE_TES_U_Sc_Ad.EDS)																																							
TeSysU_Sc_Mu_L	ULTIMA : Multifunction Starter-Controller in Local mode (TE_TES_U_Sc_Mu_L.EDS)																																							
TeSysU_Sc_Mu_R	ULTIMA : Multifunction Starter-Controller in Remote mode (TE_TES_U_Sc_Mu_R.EDS)																																							
TeSysU_Sc_St	ULTIMA : Standard Starter-Controller in Remote mode (TE_TES_U_Sc_St.EDS)																																							

<p>9</p>	<p>All CANopen nodes should now be displayed in the project browser.</p>	
----------	--	--

CANopen PDO Parameterization

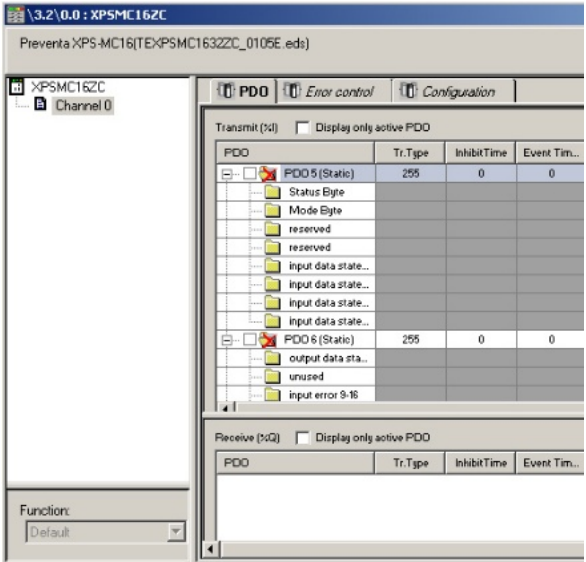
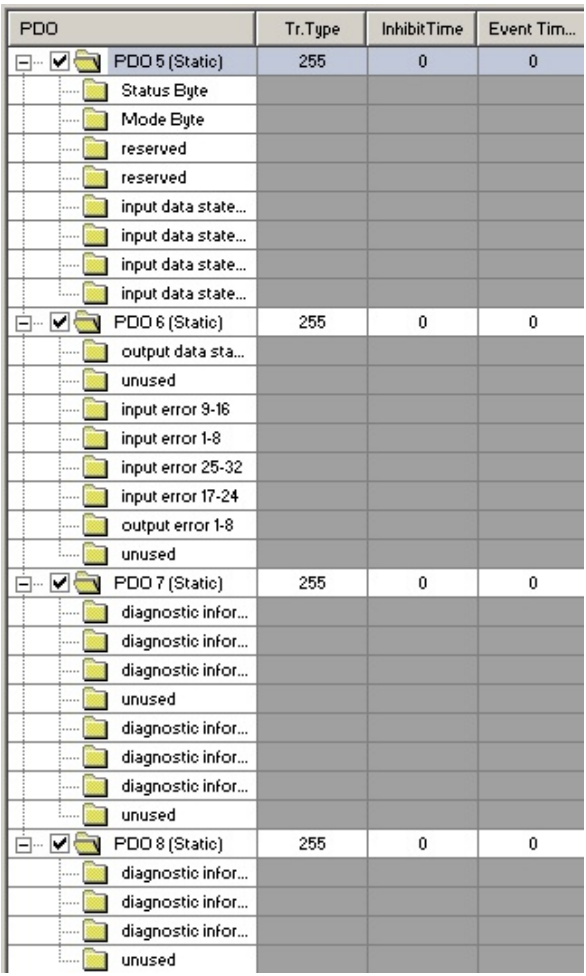
<p>1</p>	<p>You must now parameterize the cyclic data exchange that takes place via the PDOs.</p> <p>To do this, select Open from the pop-up menu for each node and go to the PDO tab in the window that appears.</p>	
----------	--	--

<p>2</p> <p>Initially, no PDO is activated for the safety controller.</p> <p>The following PDOs are selected for operation:</p> <p style="text-align: center;"> PDO 5 transmit PDO 6 transmit PDO 7 transmit PDO 8 transmit </p> <p>Note: Further details on the PDOs used, COB_ID, Transmission Type, Inhibit and Event Time for all CANopen nodes can be found in the chapter "Communication".</p>	 <table border="1" data-bbox="1077 302 1453 571"> <thead> <tr> <th>PDO</th> <th>Tr.Type</th> <th>InhibitTime</th> <th>Event Tim...</th> </tr> </thead> <tbody> <tr> <td><input checked="" type="checkbox"/> PDO 5 (Static)</td> <td>255</td> <td>0</td> <td>0</td> </tr> <tr> <td> Status Byte</td> <td></td> <td></td> <td></td> </tr> <tr> <td> Mode Byte</td> <td></td> <td></td> <td></td> </tr> <tr> <td> reserved</td> <td></td> <td></td> <td></td> </tr> <tr> <td> reserved</td> <td></td> <td></td> <td></td> </tr> <tr> <td> input data state...</td> <td></td> <td></td> <td></td> </tr> <tr> <td> input data state...</td> <td></td> <td></td> <td></td> </tr> <tr> <td> input data state...</td> <td></td> <td></td> <td></td> </tr> <tr> <td> input data state...</td> <td></td> <td></td> <td></td> </tr> <tr> <td><input checked="" type="checkbox"/> PDO 6 (Static)</td> <td>255</td> <td>0</td> <td>0</td> </tr> <tr> <td> output data sta...</td> <td></td> <td></td> <td></td> </tr> <tr> <td> unused</td> <td></td> <td></td> <td></td> </tr> <tr> <td> input error 9-16</td> <td></td> <td></td> <td></td> </tr> </tbody> </table>	PDO	Tr.Type	InhibitTime	Event Tim...	<input checked="" type="checkbox"/> PDO 5 (Static)	255	0	0	Status Byte				Mode Byte				reserved				reserved				input data state...				input data state...				input data state...				input data state...				<input checked="" type="checkbox"/> PDO 6 (Static)	255	0	0	output data sta...				unused				input error 9-16																																																																															
PDO	Tr.Type	InhibitTime	Event Tim...																																																																																																																																		
<input checked="" type="checkbox"/> PDO 5 (Static)	255	0	0																																																																																																																																		
Status Byte																																																																																																																																					
Mode Byte																																																																																																																																					
reserved																																																																																																																																					
reserved																																																																																																																																					
input data state...																																																																																																																																					
input data state...																																																																																																																																					
input data state...																																																																																																																																					
input data state...																																																																																																																																					
<input checked="" type="checkbox"/> PDO 6 (Static)	255	0	0																																																																																																																																		
output data sta...																																																																																																																																					
unused																																																																																																																																					
input error 9-16																																																																																																																																					
<p>3</p> <p>The PDOs selected for the safety controller are displayed here.</p>	 <table border="1" data-bbox="869 741 1458 1713"> <thead> <tr> <th>PDO</th> <th>Tr.Type</th> <th>InhibitTime</th> <th>Event Tim...</th> </tr> </thead> <tbody> <tr> <td><input checked="" type="checkbox"/> PDO 5 (Static)</td> <td>255</td> <td>0</td> <td>0</td> </tr> <tr> <td> Status Byte</td> <td></td> <td></td> <td></td> </tr> <tr> <td> Mode Byte</td> <td></td> <td></td> <td></td> </tr> <tr> <td> reserved</td> <td></td> <td></td> <td></td> </tr> <tr> <td> reserved</td> <td></td> <td></td> <td></td> </tr> <tr> <td> input data state...</td> <td></td> <td></td> <td></td> </tr> <tr> <td> input data state...</td> <td></td> <td></td> <td></td> </tr> <tr> <td> input data state...</td> <td></td> <td></td> <td></td> </tr> <tr> <td> input data state...</td> <td></td> <td></td> <td></td> </tr> <tr> <td><input checked="" type="checkbox"/> PDO 6 (Static)</td> <td>255</td> <td>0</td> <td>0</td> </tr> <tr> <td> output data sta...</td> <td></td> <td></td> <td></td> </tr> <tr> <td> unused</td> <td></td> <td></td> <td></td> </tr> <tr> <td> input error 9-16</td> <td></td> <td></td> <td></td> </tr> <tr> <td> input error 1-8</td> <td></td> <td></td> <td></td> </tr> <tr> <td> input error 25-32</td> <td></td> <td></td> <td></td> </tr> <tr> <td> input error 17-24</td> <td></td> <td></td> <td></td> </tr> <tr> <td> output error 1-8</td> <td></td> <td></td> <td></td> </tr> <tr> <td> unused</td> <td></td> <td></td> <td></td> </tr> <tr> <td><input checked="" type="checkbox"/> PDO 7 (Static)</td> <td>255</td> <td>0</td> <td>0</td> </tr> <tr> <td> diagnostic infor...</td> <td></td> <td></td> <td></td> </tr> <tr> <td> diagnostic infor...</td> <td></td> <td></td> <td></td> </tr> <tr> <td> diagnostic infor...</td> <td></td> <td></td> <td></td> </tr> <tr> <td> unused</td> <td></td> <td></td> <td></td> </tr> <tr> <td> diagnostic infor...</td> <td></td> <td></td> <td></td> </tr> <tr> <td> diagnostic infor...</td> <td></td> <td></td> <td></td> </tr> <tr> <td> diagnostic infor...</td> <td></td> <td></td> <td></td> </tr> <tr> <td> unused</td> <td></td> <td></td> <td></td> </tr> <tr> <td><input checked="" type="checkbox"/> PDO 8 (Static)</td> <td>255</td> <td>0</td> <td>0</td> </tr> <tr> <td> diagnostic infor...</td> <td></td> <td></td> <td></td> </tr> <tr> <td> diagnostic infor...</td> <td></td> <td></td> <td></td> </tr> <tr> <td> diagnostic infor...</td> <td></td> <td></td> <td></td> </tr> <tr> <td> unused</td> <td></td> <td></td> <td></td> </tr> </tbody> </table>	PDO	Tr.Type	InhibitTime	Event Tim...	<input checked="" type="checkbox"/> PDO 5 (Static)	255	0	0	Status Byte				Mode Byte				reserved				reserved				input data state...				input data state...				input data state...				input data state...				<input checked="" type="checkbox"/> PDO 6 (Static)	255	0	0	output data sta...				unused				input error 9-16				input error 1-8				input error 25-32				input error 17-24				output error 1-8				unused				<input checked="" type="checkbox"/> PDO 7 (Static)	255	0	0	diagnostic infor...				diagnostic infor...				diagnostic infor...				unused				diagnostic infor...				diagnostic infor...				diagnostic infor...				unused				<input checked="" type="checkbox"/> PDO 8 (Static)	255	0	0	diagnostic infor...				diagnostic infor...				diagnostic infor...				unused			
PDO	Tr.Type	InhibitTime	Event Tim...																																																																																																																																		
<input checked="" type="checkbox"/> PDO 5 (Static)	255	0	0																																																																																																																																		
Status Byte																																																																																																																																					
Mode Byte																																																																																																																																					
reserved																																																																																																																																					
reserved																																																																																																																																					
input data state...																																																																																																																																					
input data state...																																																																																																																																					
input data state...																																																																																																																																					
input data state...																																																																																																																																					
<input checked="" type="checkbox"/> PDO 6 (Static)	255	0	0																																																																																																																																		
output data sta...																																																																																																																																					
unused																																																																																																																																					
input error 9-16																																																																																																																																					
input error 1-8																																																																																																																																					
input error 25-32																																																																																																																																					
input error 17-24																																																																																																																																					
output error 1-8																																																																																																																																					
unused																																																																																																																																					
<input checked="" type="checkbox"/> PDO 7 (Static)	255	0	0																																																																																																																																		
diagnostic infor...																																																																																																																																					
diagnostic infor...																																																																																																																																					
diagnostic infor...																																																																																																																																					
unused																																																																																																																																					
diagnostic infor...																																																																																																																																					
diagnostic infor...																																																																																																																																					
diagnostic infor...																																																																																																																																					
unused																																																																																																																																					
<input checked="" type="checkbox"/> PDO 8 (Static)	255	0	0																																																																																																																																		
diagnostic infor...																																																																																																																																					
diagnostic infor...																																																																																																																																					
diagnostic infor...																																																																																																																																					
unused																																																																																																																																					
<p>4</p> <p>Click the tick icon to validate the entries.</p>																																																																																																																																					

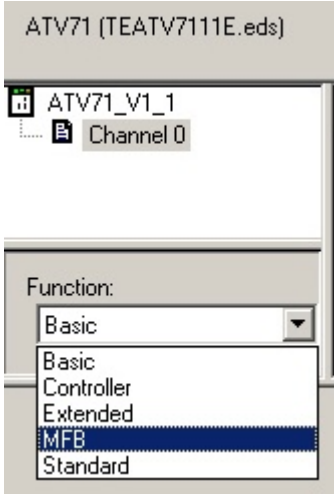
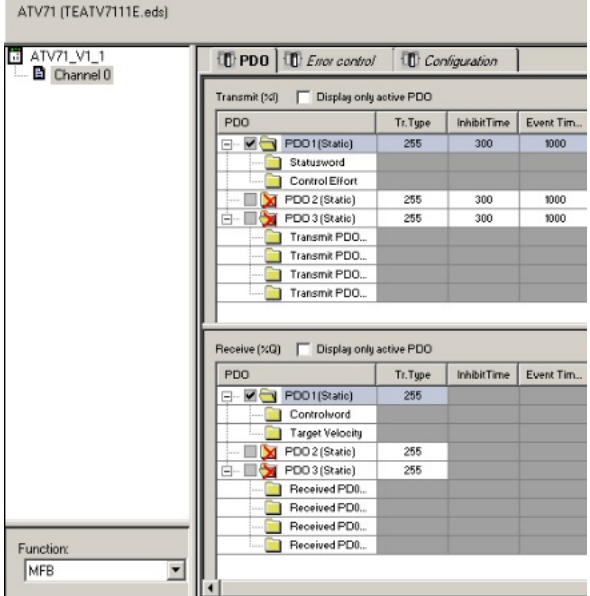
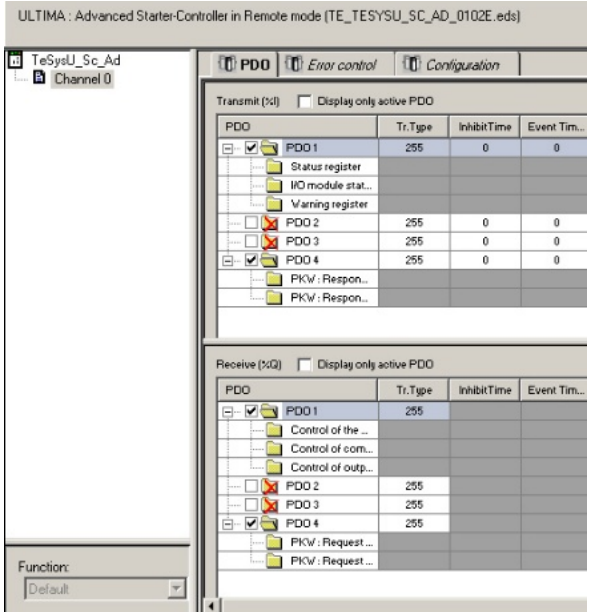

<p>5</p>	<p>If variables with topological addresses have been assigned, these are displayed in the Symbol column.</p>	
<p>6</p>	<p>Since the Lexium 05 servo drive is controlled via MFB, no changes can be made to the PDOs.</p> <p>These are set as follows:</p> <p>PDO 1 transmit PDO 4 transmit PDO 1 receive</p>	
<p>7</p>	<p>The Lexium 15 LP servo drive is controlled via MFB.</p> <p>The PDOs are set as follows:</p> <p>PDO 1 transmit PDO 2 transmit PDO 1 receive PDO 2 receive PDO 3 receive</p>	

<p>8</p>	<p>MFB is also used with the Altivar 71 variable speed drive.</p> <p>To activate this, you must select MFB in the Function drop-down list.</p>	 <p>ATV71 (TEATV7111E.eds)</p> <p>ATV71_V1_1 Channel 0</p> <p>Function: Basic Basic Controller Extended MFB Standard</p>																																																																																
<p>9</p>	<p>The PDOs will then be set as follows:</p> <p>PDO 1 transmit PDO 1 receive</p>	 <p>ATV71 (TEATV7111E.eds)</p> <p>ATV71_V1_1 Channel 0</p> <p>Transmit (Tx) <input type="checkbox"/> Display only active PDO</p> <table border="1"> <thead> <tr> <th>PDO</th> <th>Tr.Type</th> <th>InhibitTime</th> <th>Event Tim...</th> </tr> </thead> <tbody> <tr> <td><input checked="" type="checkbox"/> PDO 1 (Static)</td> <td>255</td> <td>300</td> <td>1000</td> </tr> <tr> <td>Statusword</td> <td></td> <td></td> <td></td> </tr> <tr> <td>Control Effort</td> <td></td> <td></td> <td></td> </tr> <tr> <td><input checked="" type="checkbox"/> PDO 2 (Static)</td> <td>255</td> <td>300</td> <td>1000</td> </tr> <tr> <td><input checked="" type="checkbox"/> PDO 3 (Static)</td> <td>255</td> <td>300</td> <td>1000</td> </tr> <tr> <td>Transmit PDO...</td> <td></td> <td></td> <td></td> </tr> <tr> <td>Transmit PDO...</td> <td></td> <td></td> <td></td> </tr> <tr> <td>Transmit PDO...</td> <td></td> <td></td> <td></td> </tr> <tr> <td>Transmit PDO...</td> <td></td> <td></td> <td></td> </tr> </tbody> </table> <p>Receive (Rx) <input type="checkbox"/> Display only active PDO</p> <table border="1"> <thead> <tr> <th>PDO</th> <th>Tr.Type</th> <th>InhibitTime</th> <th>Event Tim...</th> </tr> </thead> <tbody> <tr> <td><input checked="" type="checkbox"/> PDO 1 (Static)</td> <td>255</td> <td></td> <td></td> </tr> <tr> <td>Controlword</td> <td></td> <td></td> <td></td> </tr> <tr> <td>Target Velocity</td> <td></td> <td></td> <td></td> </tr> <tr> <td><input checked="" type="checkbox"/> PDO 2 (Static)</td> <td>255</td> <td></td> <td></td> </tr> <tr> <td><input checked="" type="checkbox"/> PDO 3 (Static)</td> <td>255</td> <td></td> <td></td> </tr> <tr> <td>Received PDO...</td> <td></td> <td></td> <td></td> </tr> <tr> <td>Received PDO...</td> <td></td> <td></td> <td></td> </tr> <tr> <td>Received PDO...</td> <td></td> <td></td> <td></td> </tr> <tr> <td>Received PDO...</td> <td></td> <td></td> <td></td> </tr> </tbody> </table> <p>Function: MFB</p>	PDO	Tr.Type	InhibitTime	Event Tim...	<input checked="" type="checkbox"/> PDO 1 (Static)	255	300	1000	Statusword				Control Effort				<input checked="" type="checkbox"/> PDO 2 (Static)	255	300	1000	<input checked="" type="checkbox"/> PDO 3 (Static)	255	300	1000	Transmit PDO...				Transmit PDO...				Transmit PDO...				Transmit PDO...				PDO	Tr.Type	InhibitTime	Event Tim...	<input checked="" type="checkbox"/> PDO 1 (Static)	255			Controlword				Target Velocity				<input checked="" type="checkbox"/> PDO 2 (Static)	255			<input checked="" type="checkbox"/> PDO 3 (Static)	255			Received PDO...				Received PDO...				Received PDO...				Received PDO...			
PDO	Tr.Type	InhibitTime	Event Tim...																																																																															
<input checked="" type="checkbox"/> PDO 1 (Static)	255	300	1000																																																																															
Statusword																																																																																		
Control Effort																																																																																		
<input checked="" type="checkbox"/> PDO 2 (Static)	255	300	1000																																																																															
<input checked="" type="checkbox"/> PDO 3 (Static)	255	300	1000																																																																															
Transmit PDO...																																																																																		
Transmit PDO...																																																																																		
Transmit PDO...																																																																																		
Transmit PDO...																																																																																		
PDO	Tr.Type	InhibitTime	Event Tim...																																																																															
<input checked="" type="checkbox"/> PDO 1 (Static)	255																																																																																	
Controlword																																																																																		
Target Velocity																																																																																		
<input checked="" type="checkbox"/> PDO 2 (Static)	255																																																																																	
<input checked="" type="checkbox"/> PDO 3 (Static)	255																																																																																	
Received PDO...																																																																																		
Received PDO...																																																																																		
Received PDO...																																																																																		
Received PDO...																																																																																		
<p>10</p>	<p>The default PDOs are accepted for the TeSysU.</p> <p>These are:</p> <p>PDO 1 transmit PDO 4 transmit PDO 1 receive PDO 4 receive</p>	 <p>ULTIMA : Advanced Starter-Controller in Remote mode (TE_TESYSU_SC_AD_0102E.eds)</p> <p>TeSysU_Sc_Ad Channel 0</p> <p>Transmit (Tx) <input type="checkbox"/> Display only active PDO</p> <table border="1"> <thead> <tr> <th>PDO</th> <th>Tr.Type</th> <th>InhibitTime</th> <th>Event Tim...</th> </tr> </thead> <tbody> <tr> <td><input checked="" type="checkbox"/> PDO 1</td> <td>255</td> <td>0</td> <td>0</td> </tr> <tr> <td>Status register</td> <td></td> <td></td> <td></td> </tr> <tr> <td>IO module stat...</td> <td></td> <td></td> <td></td> </tr> <tr> <td>Warning register</td> <td></td> <td></td> <td></td> </tr> <tr> <td><input checked="" type="checkbox"/> PDO 2</td> <td>255</td> <td>0</td> <td>0</td> </tr> <tr> <td><input checked="" type="checkbox"/> PDO 3</td> <td>255</td> <td>0</td> <td>0</td> </tr> <tr> <td><input checked="" type="checkbox"/> PDO 4</td> <td>255</td> <td>0</td> <td>0</td> </tr> <tr> <td>PKW: Respon...</td> <td></td> <td></td> <td></td> </tr> <tr> <td>PKW: Respon...</td> <td></td> <td></td> <td></td> </tr> </tbody> </table> <p>Receive (Rx) <input type="checkbox"/> Display only active PDO</p> <table border="1"> <thead> <tr> <th>PDO</th> <th>Tr.Type</th> <th>InhibitTime</th> <th>Event Tim...</th> </tr> </thead> <tbody> <tr> <td><input checked="" type="checkbox"/> PDO 1</td> <td>255</td> <td></td> <td></td> </tr> <tr> <td>Control of the ...</td> <td></td> <td></td> <td></td> </tr> <tr> <td>Control of com...</td> <td></td> <td></td> <td></td> </tr> <tr> <td>Control of outp...</td> <td></td> <td></td> <td></td> </tr> <tr> <td><input checked="" type="checkbox"/> PDO 2</td> <td>255</td> <td></td> <td></td> </tr> <tr> <td><input checked="" type="checkbox"/> PDO 3</td> <td>255</td> <td></td> <td></td> </tr> <tr> <td><input checked="" type="checkbox"/> PDO 4</td> <td>255</td> <td></td> <td></td> </tr> <tr> <td>PKW: Request ...</td> <td></td> <td></td> <td></td> </tr> <tr> <td>PKW: Request ...</td> <td></td> <td></td> <td></td> </tr> </tbody> </table> <p>Function: Default</p>	PDO	Tr.Type	InhibitTime	Event Tim...	<input checked="" type="checkbox"/> PDO 1	255	0	0	Status register				IO module stat...				Warning register				<input checked="" type="checkbox"/> PDO 2	255	0	0	<input checked="" type="checkbox"/> PDO 3	255	0	0	<input checked="" type="checkbox"/> PDO 4	255	0	0	PKW: Respon...				PKW: Respon...				PDO	Tr.Type	InhibitTime	Event Tim...	<input checked="" type="checkbox"/> PDO 1	255			Control of the ...				Control of com...				Control of outp...				<input checked="" type="checkbox"/> PDO 2	255			<input checked="" type="checkbox"/> PDO 3	255			<input checked="" type="checkbox"/> PDO 4	255			PKW: Request ...				PKW: Request ...			
PDO	Tr.Type	InhibitTime	Event Tim...																																																																															
<input checked="" type="checkbox"/> PDO 1	255	0	0																																																																															
Status register																																																																																		
IO module stat...																																																																																		
Warning register																																																																																		
<input checked="" type="checkbox"/> PDO 2	255	0	0																																																																															
<input checked="" type="checkbox"/> PDO 3	255	0	0																																																																															
<input checked="" type="checkbox"/> PDO 4	255	0	0																																																																															
PKW: Respon...																																																																																		
PKW: Respon...																																																																																		
PDO	Tr.Type	InhibitTime	Event Tim...																																																																															
<input checked="" type="checkbox"/> PDO 1	255																																																																																	
Control of the ...																																																																																		
Control of com...																																																																																		
Control of outp...																																																																																		
<input checked="" type="checkbox"/> PDO 2	255																																																																																	
<input checked="" type="checkbox"/> PDO 3	255																																																																																	
<input checked="" type="checkbox"/> PDO 4	255																																																																																	
PKW: Request ...																																																																																		
PKW: Request ...																																																																																		

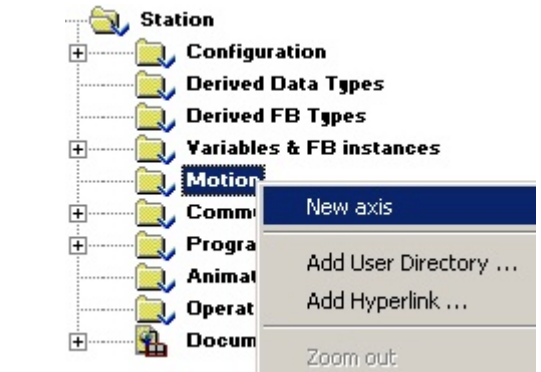
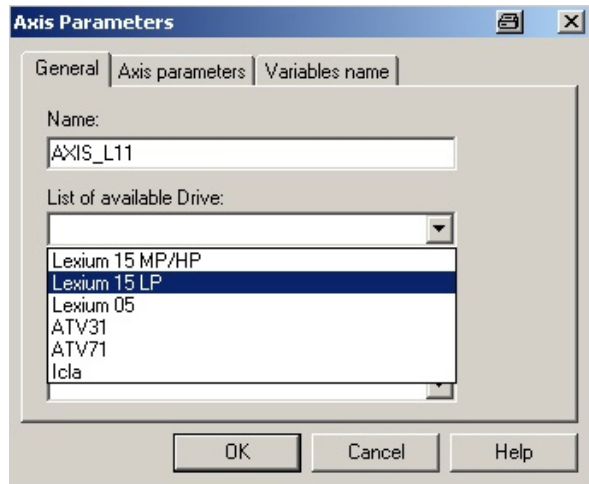
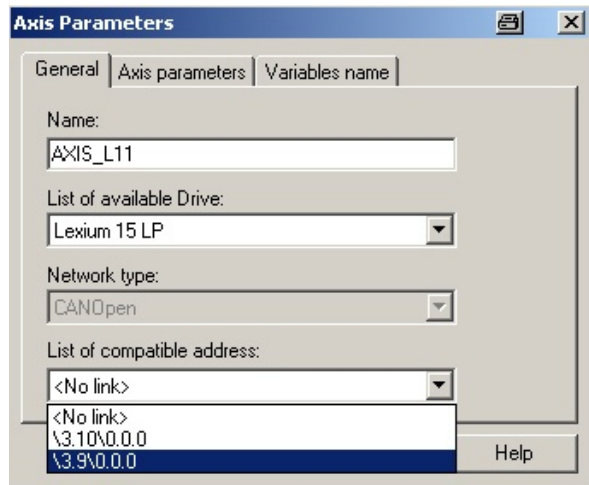
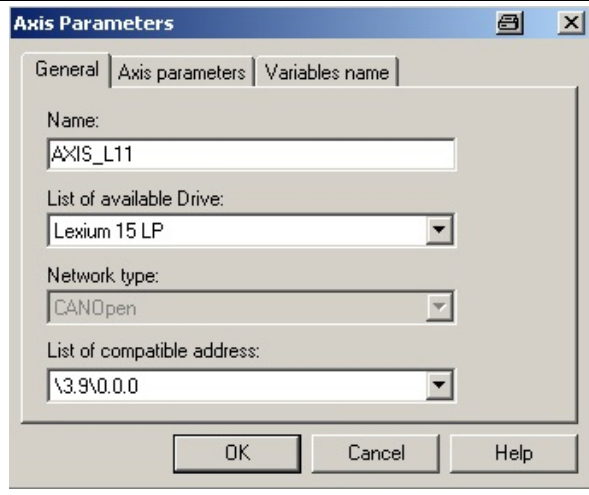
Setting Up Axes For the Drives

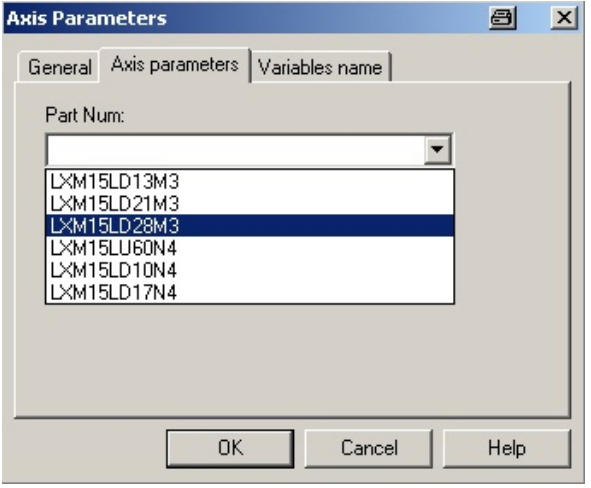
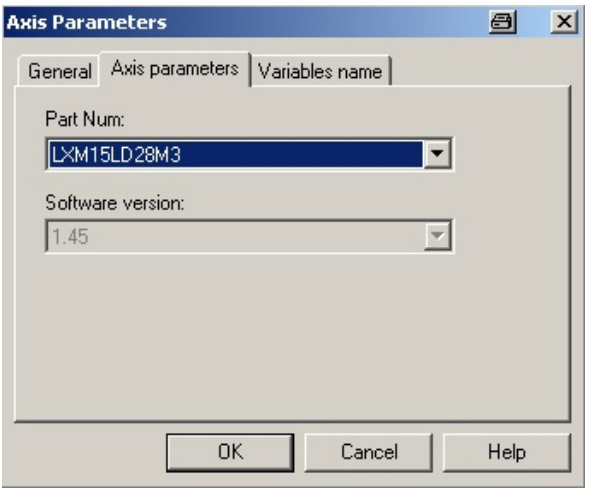
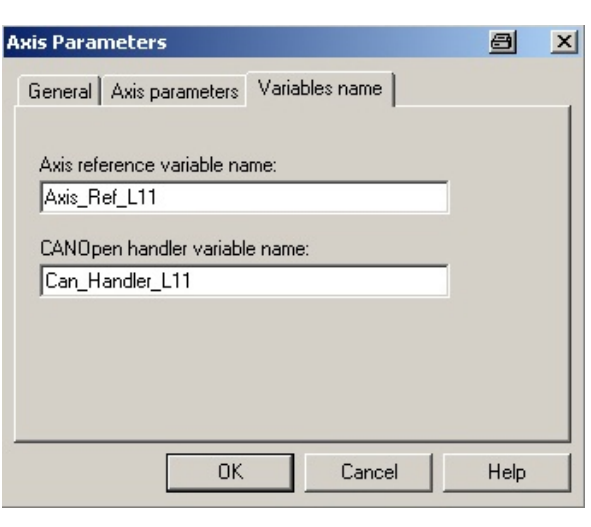
<p>1</p>	<p>To use the drive with MFB (Motion Function Block), you must first set up an axis.</p> <p>To do this, select Motion in the project browser followed by New axis from the pop-up menu.</p>	
<p>2</p>	<p>For the two Lexium 15 LP servo drives, first assign an axis name and a drive type on the General tab.</p> <p>In this application, the following apply:</p> <p>Name: AXIS_L11 (1st LXM) AXIS_L12 (2nd LXM)</p> <p>Type: Lexium 15 LP</p>	
<p>3</p>	<p>Unity Pro provides a list of compatible CANopen addresses to choose from.</p> <p>In this application, the following can be selected:</p> <p>Address: \3.9\ (1st LXM) \3.10\ (2nd LXM)</p>	
<p>4</p>	<p>The completed General tab is shown here.</p>	

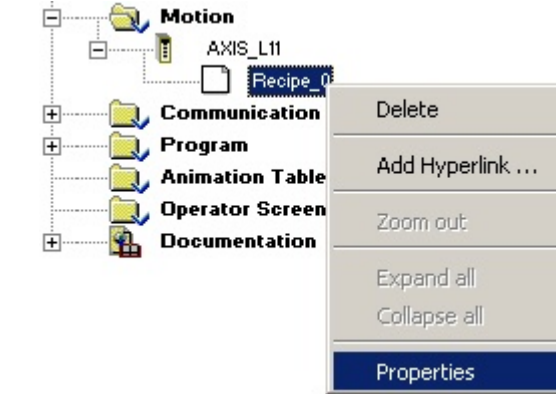
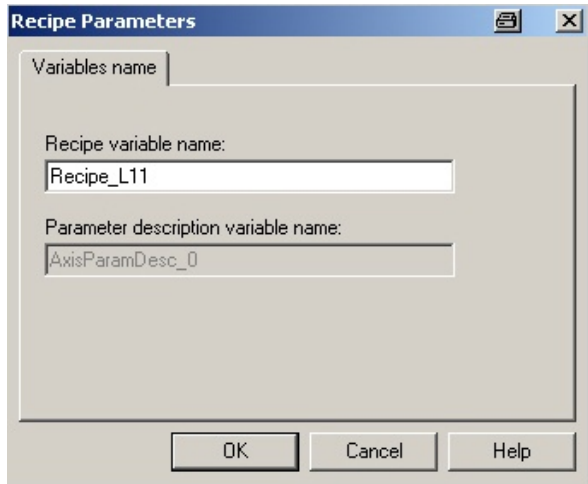
<p>5</p>	<p>Enter the order reference on the Axis parameters tab.</p> <p>In this application, the following is used:</p> <p>Reference: LXM15LD28M3</p>	
<p>6</p>	<p>The software version cannot be changed.</p> <p>SV: 1.45</p>	
<p>7</p>	<p>Define the associated variables on the Variables name tab.</p> <p>For the 1st Lexium 15, the following are used:</p> <p style="padding-left: 40px;">Axis_Ref_L11 Can_Handler_L11</p> <p>and for the 2nd Lexium 15:</p> <p style="padding-left: 40px;">Axis_Ref_L12 Can_Handler_L12</p> <p>Click OK to confirm.</p>	

8	<p>A recipe is assigned to the axis.</p> <p>To adjust the settings, you must highlight it and select Properties.</p>					
9	<p>Enter the recipe variable name here. Unity accepts the parameter assignment.</p> <p>For the Lexium 15 LP, the following apply:</p> <p>Name: Recipe_L11 (1st LXM) Recipe_L12 (2nd LXM)</p> <p>Click OK to exit the window.</p>					
10	<p>The contents of the project browser is updated.</p>					
11	<p>The table below provides a summary of the entries for all drives.</p>					
<p>Drive</p>		<p>CANopen Address</p>		<p>Variable Names with Axis for</p>		
		<p>Name: AXIS</p>	<p>Axis_Ref</p>	<p>CAN_Handler</p>	<p>Recipe</p>	<p>AxisParam</p>
1. LXM05	\3.3\	_L01	_L01	_L01	_L01	Desc_2
2. LXM05	\3.4\	_L02	_L02	_L02	_L02	Desc_2
3. LXM05	\3.5\	_L03	_L03	_L03	_L03	Desc_2
4. LXM05	\3.6\	_L04	_L04	_L04	_L04	Desc_2
5. LXM05	\3.7\	_L05	_L05	_L05	_L05	Desc_2
6. LXM05	\3.8\	_L06	_L06	_L06	_L06	Desc_2
1. LXM15	\3.9\	_L11	_L11	_L11	_L11	Desc_0
2. LXM15	\3.10\	_L12	_L12	_L12	_L12	Desc_0
1. ATV71	\3.11\	_A01	_A01	_A01	_A01	Desc_1
2. ATV71	\3.12\	_A02	_A02	_A02	_A02	Desc_1
3. ATV71	\3.13\	_A03	_A03	_A03	_A03	Desc_1
4. ATV71	\3.14\	_A04	_A04	_A04	_A04	Desc_1
5. ATV71	\3.15\	_A05	_A05	_A05	_A05	Desc_1
6. ATV71	\3.16\	_A06	_A06	_A06	_A06	Desc_1
<p>Note: The AxisParam name is automatically assigned by Unity Pro, and depends on the parameterization order. Although discrepancies may occur in this respect, in effect the function remains the same.</p>						

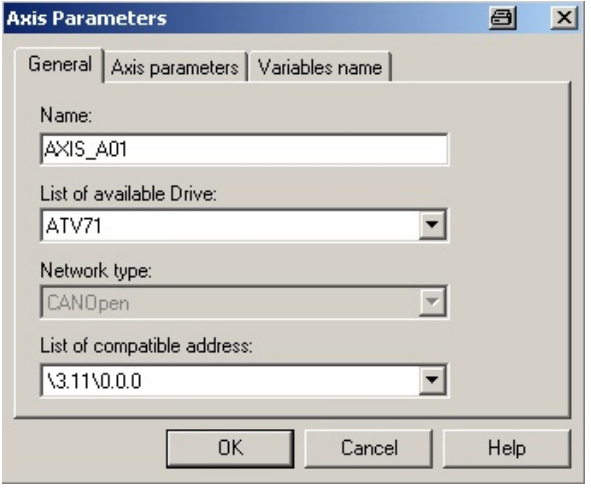
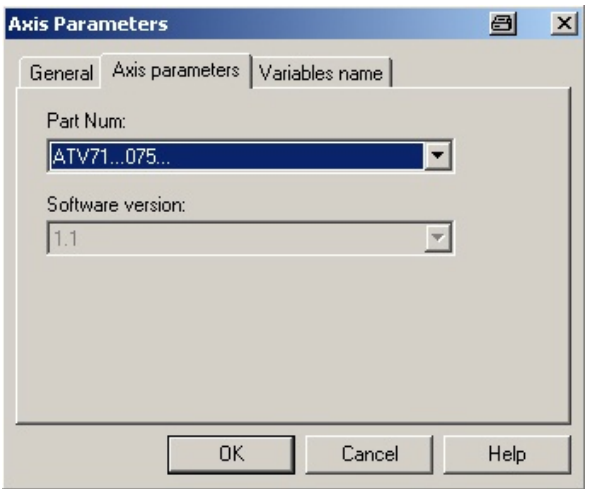
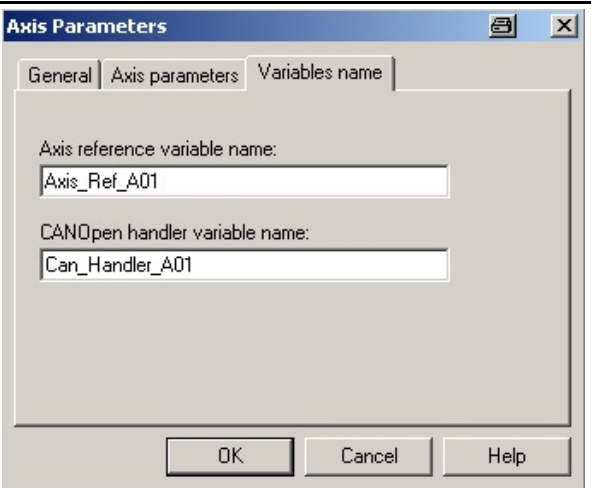
<p>12</p>	<p>For the six Altivar 71 variable speed drives, enter the following on the General tab:</p> <p>Name: AXIS_A01 (1st ATV) to ... A06 (6th ATV)</p> <p>Type: ATV71</p> <p>Address: \3.11\0.0.0 to \3.16\0.0.0</p>	
<p>13</p>	<p>Enter the following on the Axis parameters tab:</p> <p>Reference: ATV71...075... SV: Automatic</p>	
<p>14</p>	<p>The following variables are used on the Variables name tab.</p> <p>(These apply to the first to sixth Altivar drives):</p> <p>Axis_Ref_A01 to Axis_Ref_A06</p> <p>Can_Handler_A01 to Can_Handler_A06</p>	

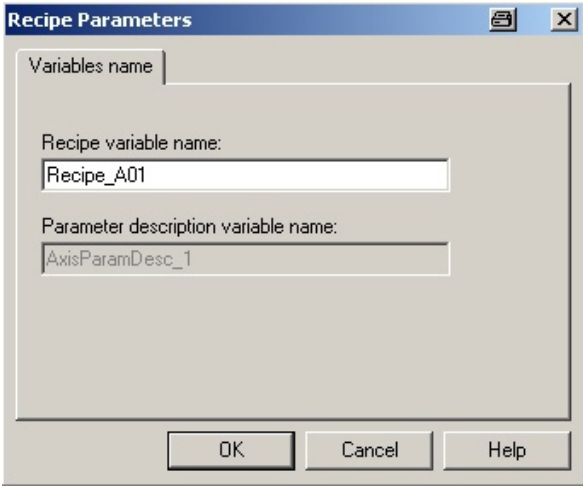
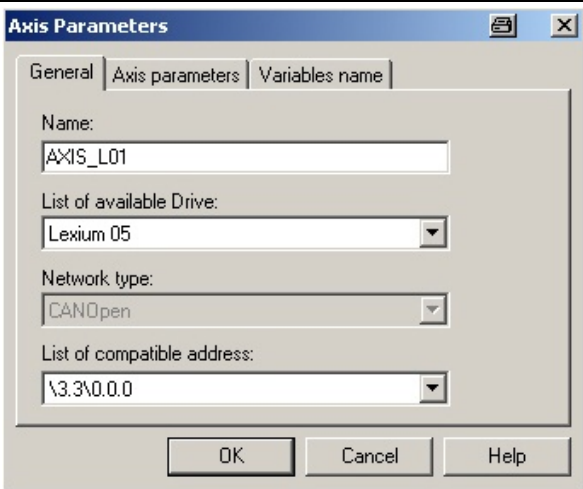
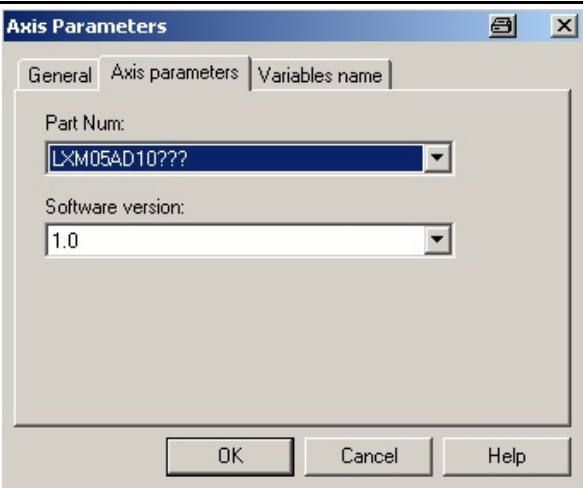
15	<p>The following variable name is used for the recipe:</p> <p>Name: Recipe_A01 to Recipe_A06</p>	
16	<p>For the six Lexium 05 servo drives, enter the following on the General tab:</p> <p>Name: AXIS_L01 to AXIS_L06</p> <p>Type: Lexium 05</p> <p>Address: \3.3\0.0.0 to \3.8\0.0.0</p>	
17	<p>Enter the following on the Axis parameters tab:</p> <p>Reference: LXM05AD10??? SV: 1.0</p>	

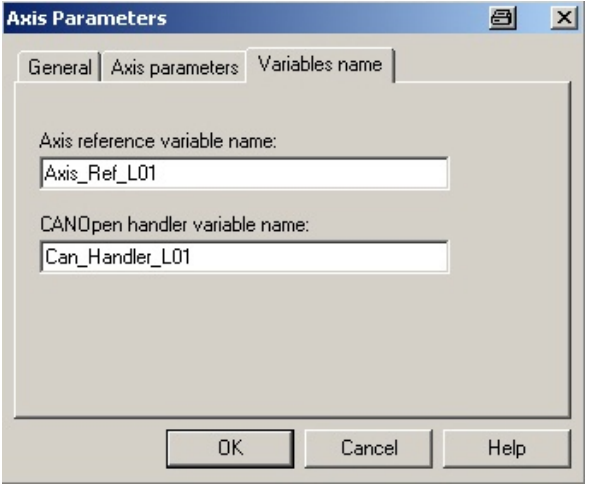
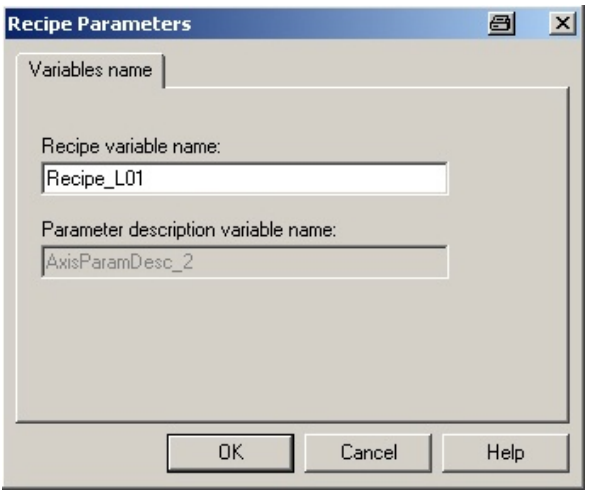
<p>18</p>	<p>The following variables are used on the Variables name tab:</p> <p>Axis_Ref_L01 to Axis_Ref_L06</p> <p>Can_Handler_L01 to Can_Handler_L06</p>	 <p>Axis Parameters</p> <p>General Axis parameters Variables name</p> <p>Axis reference variable name: Axis_Ref_L01</p> <p>CANOpen handler variable name: Can_Handler_L01</p> <p>OK Cancel Help</p>
<p>19</p>	<p>The following variable name is used for the recipe:</p> <p>Name: Recipe_L01 to Recipe_L06</p>	 <p>Recipe Parameters</p> <p>Variables name</p> <p>Recipe variable name: Recipe_L01</p> <p>Parameter description variable name: AxisParamDesc_2</p> <p>OK Cancel Help</p>

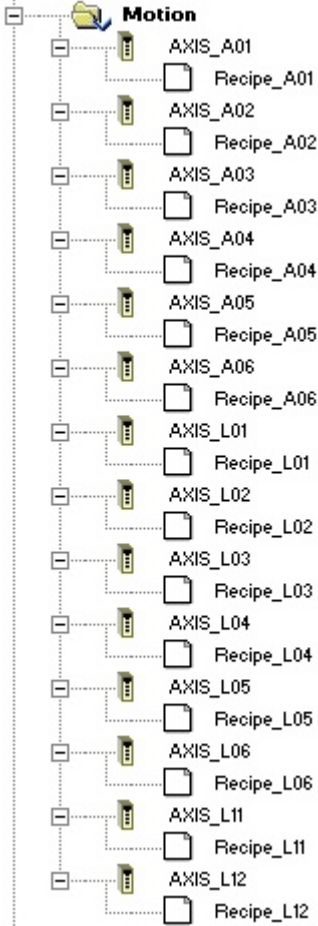
<p>20</p>	<p>Under Motion in the project browser, the axes are displayed as shown.</p>	 <p>The screenshot shows a hierarchical project browser structure. At the top is a folder icon labeled 'Motion'. Below it, there are 12 entries, each consisting of a folder icon, an axis name, and a recipe name. The entries are: <ul style="list-style-type: none"> AXIS_A01 (Recipe_A01) AXIS_A02 (Recipe_A02) AXIS_A03 (Recipe_A03) AXIS_A04 (Recipe_A04) AXIS_A05 (Recipe_A05) AXIS_A06 (Recipe_A06) AXIS_L01 (Recipe_L01) AXIS_L02 (Recipe_L02) AXIS_L03 (Recipe_L03) AXIS_L04 (Recipe_L04) AXIS_L05 (Recipe_L05) AXIS_L06 (Recipe_L06) AXIS_L11 (Recipe_L11) AXIS_L12 (Recipe_L12) Each axis name is preceded by a small folder icon, and each recipe name is preceded by a document icon. Dotted lines connect the axis names to their respective recipe names, indicating a one-to-one relationship. </p>
-----------	---	---

Program Assignment

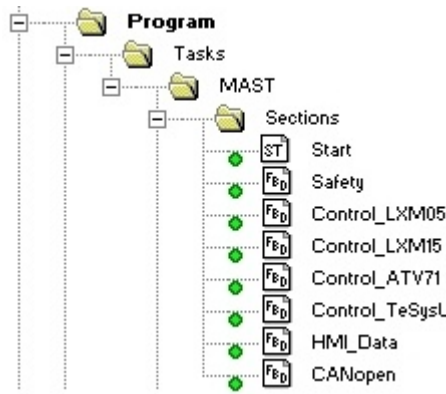
1	<p>The individual program sections are displayed under Program in the project browser.</p>															
2	<p>Here is a brief overview:</p> <table border="0"> <tr> <td>Start</td> <td>Consists of the functions that must be carried out when the application program is started (e.g., initialize variables).</td> </tr> <tr> <td>Safety</td> <td>Analyzes the information provided by the safety controller.</td> </tr> <tr> <td>Control_LXM05</td> <td rowspan="3">These sections are responsible for controlling the Lexium 15, Lexium 05 and Altivar 71 drives with Motion Function Block.</td> </tr> <tr> <td>Control_LXM15</td> </tr> <tr> <td>Control_ATV71</td> </tr> <tr> <td>Control_TeSysU</td> <td>Conventional control of two TeSysU motor starters.</td> </tr> <tr> <td>HMI_Data</td> <td>Manages the communication data with the HMI.</td> </tr> <tr> <td>CANopen</td> <td>Summarizes the CANopen information of each node.</td> </tr> </table>		Start	Consists of the functions that must be carried out when the application program is started (e.g., initialize variables).	Safety	Analyzes the information provided by the safety controller.	Control_LXM05	These sections are responsible for controlling the Lexium 15, Lexium 05 and Altivar 71 drives with Motion Function Block.	Control_LXM15	Control_ATV71	Control_TeSysU	Conventional control of two TeSysU motor starters.	HMI_Data	Manages the communication data with the HMI.	CANopen	Summarizes the CANopen information of each node.
Start	Consists of the functions that must be carried out when the application program is started (e.g., initialize variables).															
Safety	Analyzes the information provided by the safety controller.															
Control_LXM05	These sections are responsible for controlling the Lexium 15, Lexium 05 and Altivar 71 drives with Motion Function Block.															
Control_LXM15																
Control_ATV71																
Control_TeSysU	Conventional control of two TeSysU motor starters.															
HMI_Data	Manages the communication data with the HMI.															
CANopen	Summarizes the CANopen information of each node.															

**MFB
Motion
Function
Block**

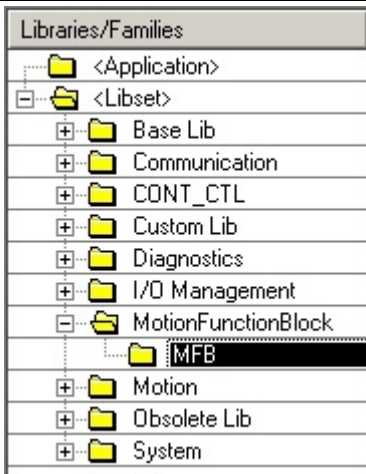
1	<p>The Motion Function Block library contains blocks for the straightforward control of servo drives and variable speed drives.</p>	
---	---	--

2 These are listed in the **FBD-Editor** under **MotionFunctionBlock** and **MFB**.

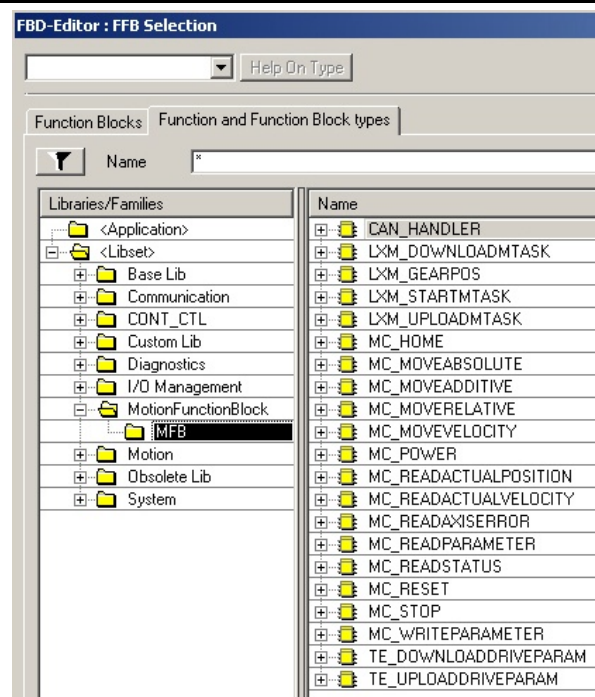

3 The following assignment table shows which blocks are available for which drive types:

Type	Block name	Lexium15 HP, MP, LP	Icla IFA, IFE, IFX	ATV31	ATV71	Lexium05
PLCopen	MC_ReadParameter	X	X	X	X	X
	MC_WriteParameter	X	X	X	X	X
	MC_ReadActualPosition	X	X			X
	MC_ReadActualVelocity	X	X	X	X	X
	MC_Reset	X	X	X	X	X
	MC_Stop	X	X	X	X	X
	MC_Power	X	X	X	X	X
	MC_MoveAbsolute	X	X			X
	MC_MoveRelative	X				X
	MC_MoveAdditive		X			X
	MC_MoveVelocity	X	X	X	X	X
	MC_ReadAxisError	X	X	X	X	X
	MC_ReadStatus	X	X	X	X	X
	MC_Home	X	X			X
Parameter set save and restore functions for management of recipes or replacement of faulty servodrives	TE_UploadDriveParam	X	X	X	X	X
	TE_DownloadDriveParam	X	X	X	X	X
Advanced functions for the Lexium 15	Lxm_GearPos	X				
	Lxm_DownloadMTask	X				
	Lxm_UploadMTask	X				
	Lxm_StartMTask	X				
System function	CAN_Handler	X	X	X	X	X

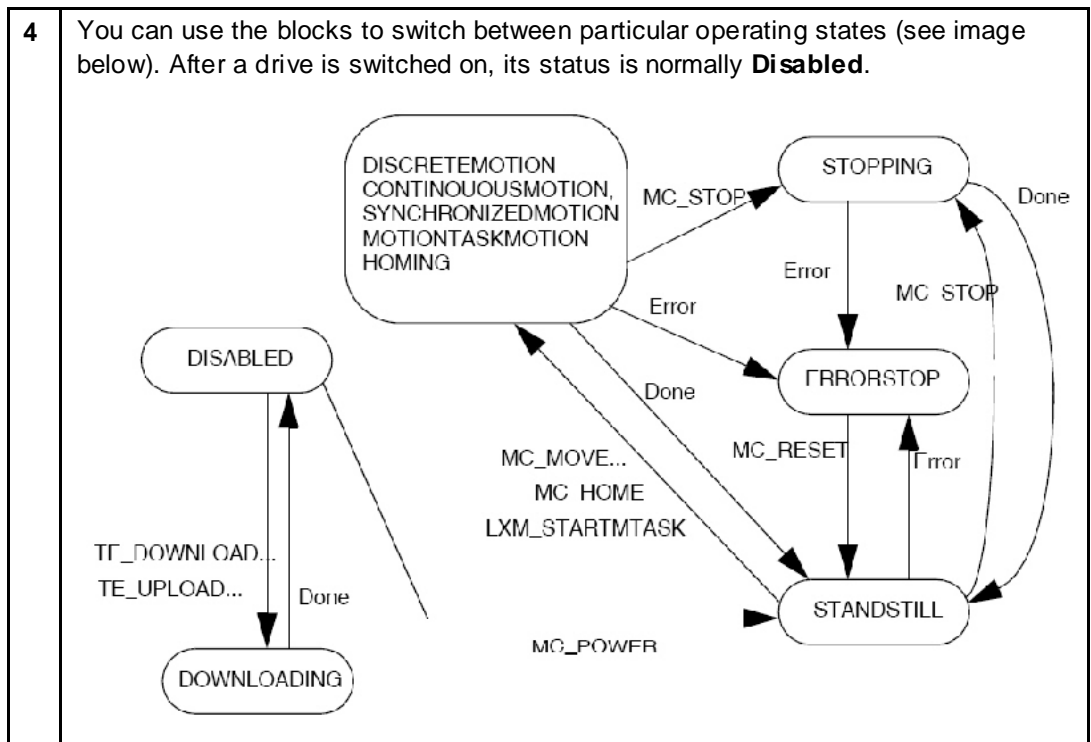

5 A **CAN_HANDLER** is absolutely essential for each drive and must be addressed in each PLC cycle. The block uses the **AXISREADY** output to indicate whether the axis/drive is available for control. The axes described above are used as parameters.

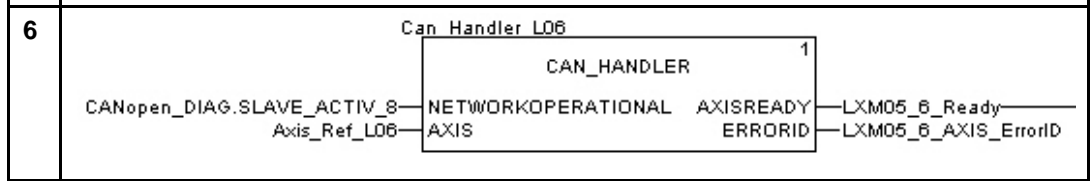

7 The image opposite shows another block which, with the assistance of the axis parameters, can control a drive using CANopen.

Please refer to the block and startup documentation for an exact description.

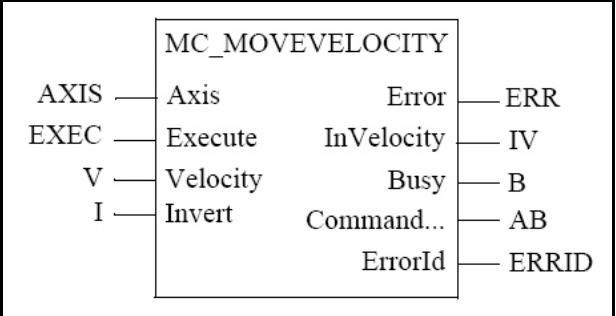

Creating and Using DFB

1 To get a compact and clear overview of the configuration, it is possible to group entire functions in a DFB.

Two DFBs have been created in this application, each of which contains the Altivar and Lexium MFBs mentioned above.

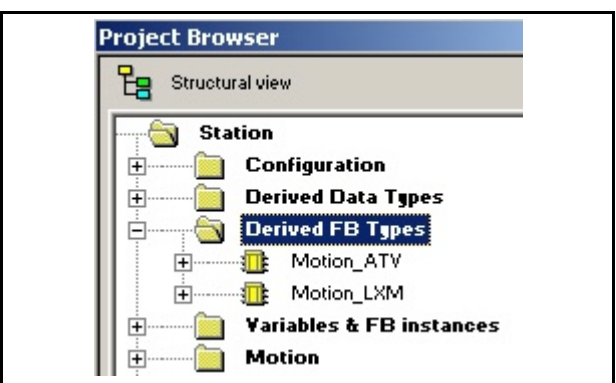

2 First, specify the block inputs and outputs.

You can determine the position on the block using the number entered.

Motion_LXM		FB		
Inputs				
Ready	1	DOOL		Axis ready from CANHANCED
Power	2	RNOI		S4 into position error
Stop	3	RNOI		S4 velocity position
Dir	4	BOOL		Change direction
Mode_VE	5	BOOL		Mode velocity
Mode_VE	6	BOOL		Mode position absolute
Mode_Rel	7	BOOL		Mode position relative
Velocity	8	DI^		Set point velocity
Position	9	DI^		Set point position
Acc	10	UDINT		S4 acceleration
Dec	11	UDINT		S4 deceleration
Axis	12	WORD_REF		Axis info
Reset	13	BOOL		Reset fault
Outputs				
Active	1	DOOL		Axis ready and powered
Disable	2	DOOL		Axis in CANAL status
Stall	3	RNOI		Axis in STANDBY status
Stopping	4	BOOL		Axis in STOPPING status
IN_VE	5	BOOL		Velocity mode active
IN_AB	6	BOOL		Absolute position mode active
IN_Rel	7	BOOL		Relative position mode active
Act_Velocity	8	DI^		Actual velocity
in_Velocity	9	DOOL		Set point velocity reached
Act_Position	10	DI^		Actual position
in_Position	11	RNOI		S4 point position reached
Error	12	BOOL		Error
ErrorID	13	UDINT		Error code
ErrorMap	14	INT		Error mapping no

3 In the Motion_LXM block, for instance, there are three sections available.

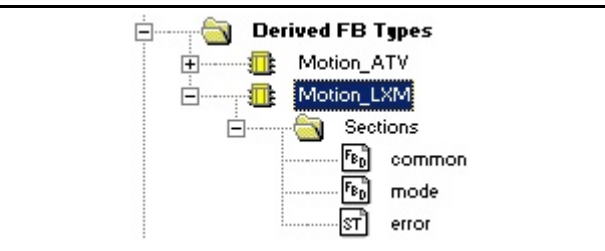

4 Common control commands are processed in the **common** section. These are:

- Block status
- Axis error message
- Power connection
- Error acknowledgement
- Actual velocity and
- Actual position

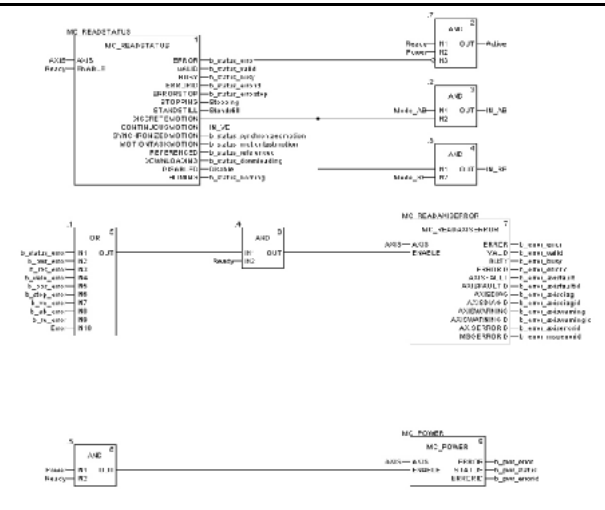

5 The **mode** section consists of:

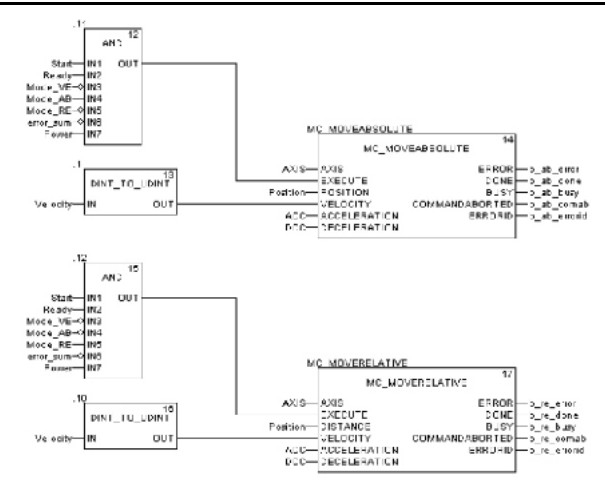

- Stop drive
- Velocity mode
- Absolute positioning mode
- Relative positioning mode



6	<p>The error section provides a summary of the error messages.</p>	<pre> ELSIF MC_READAXISERROR.MSGERRORID <> 0 THEN ErrorID := UINT_TO_UDINT (MC_READAXISERROR.MSGERRORID); ErrorMA := 16; END_IF; IF ErrorMA <> 0 THEN Error := true; ELSE Error := false; END_IF; </pre>
----------	---	---

Required Blocks

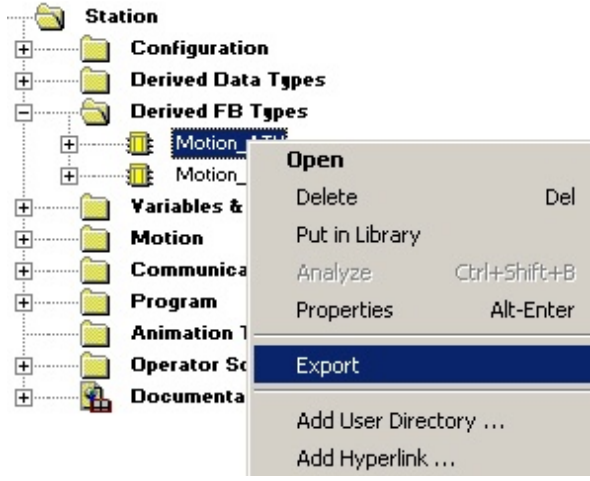
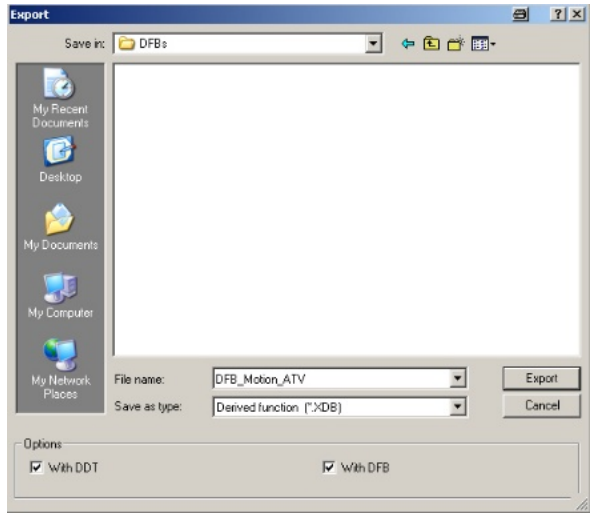
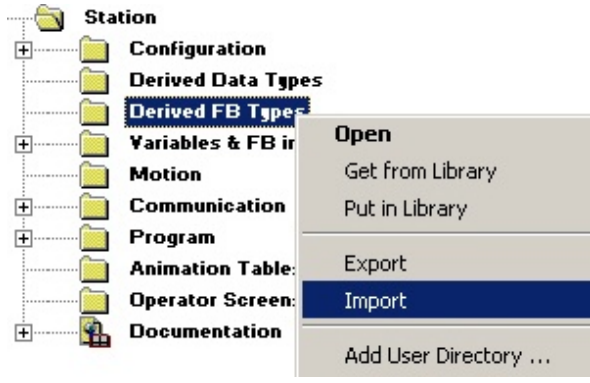

1	<p>As well as the standard blocks, two DFBs are used in the application. These are:</p> <ul style="list-style-type: none"> • Motion_LXM for Lexium 15 and Lexium 05 • Motion_ATV for Altivar 71. <p>The difference between the two blocks is that, in the case of Motion_LXM, positioning is also possible.</p>	<p>The diagram illustrates the hardware configuration for motion control. It features three main components: two CAN handlers (CAN_Handler_A01 and CAN_Handler_L06) and two FBI modules (FBI_24 and FBI_23). Each CAN handler is connected to a corresponding FBI module. The CAN_Handler_A01 is connected to FBI_24, which contains a Motion_ATV block. The CAN_Handler_L06 is connected to FBI_23, which contains a Motion_LXM block. The connections are as follows:</p> <ul style="list-style-type: none"> CAN_Handler_A01: NETWORKOPERATIONAL to FBI_24; AXISREADY to FBI_24; ERRORID to FBI_24. CAN_Handler_L06: NETWORKOPERATIONAL to FBI_23; AXISREADY to FBI_23; ERRORID to FBI_23. FBI_24 (Motion_ATV): Ready, Power, Start, Dir, Velocity, Position, ACC, DCC, AXIS, Reset, Active, Disable, Standstill, Stopping, IN_VE, Act_Velocity, in_Velocity, Error, ErrorID, ErrorMA. FBI_23 (Motion_LXM): Ready, Power, Start, Dir, Velocity, Position, ACC, DCC, AXIS, Reset, Active, Disable, Standstill, Stopping, IN_VE, Act_Velocity, in_Velocity, Error, ErrorID, ErrorMA.
----------	---	--

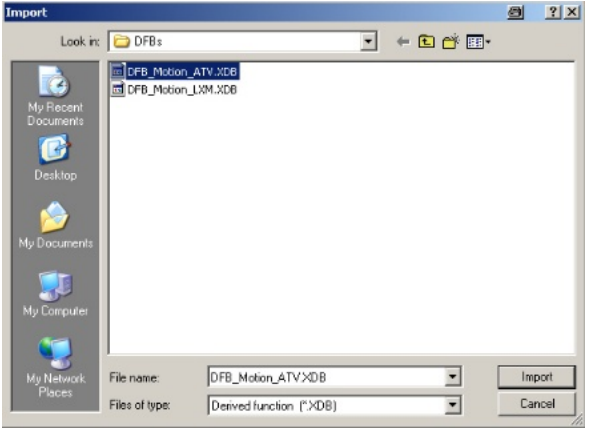
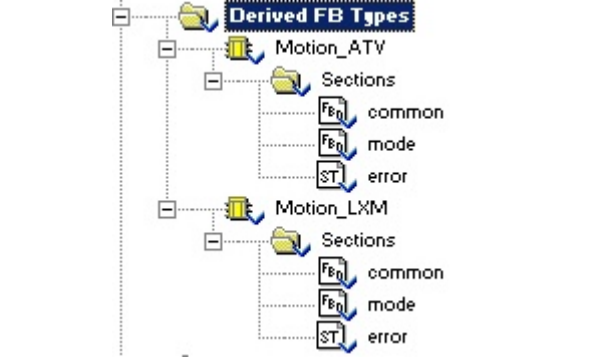

2	<p>These can be exported separately by right-clicking on the corresponding DFB and selecting Export.</p>	
3	<p>You can select any directory and file name here.</p> <p>The file name extension is .XDB.</p>	
4	<p>These can be imported into a new project at any time.</p> <p>To do this, select Import from the menu.</p>	
5	<p>Click Yes to confirm the modification and save project messages.</p>	

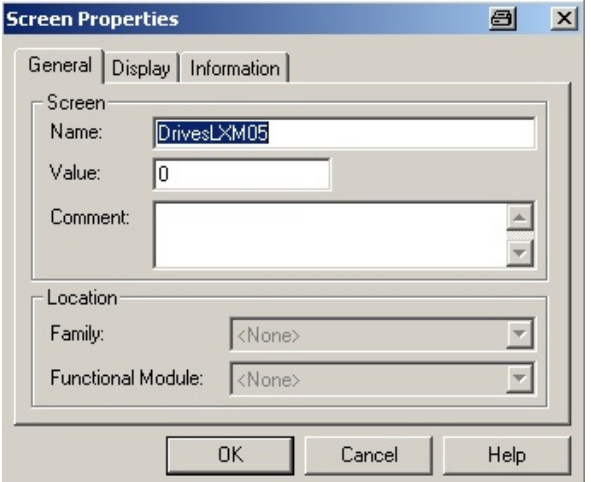
6	<p>Select the relevant file and click Import.</p>	
7	<p>The DFBs are displayed in the Derived FB Types directory.</p>	

Creating a New Operator Screen

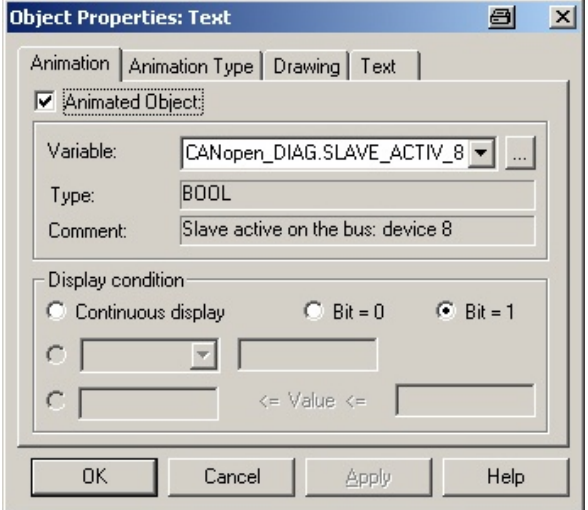
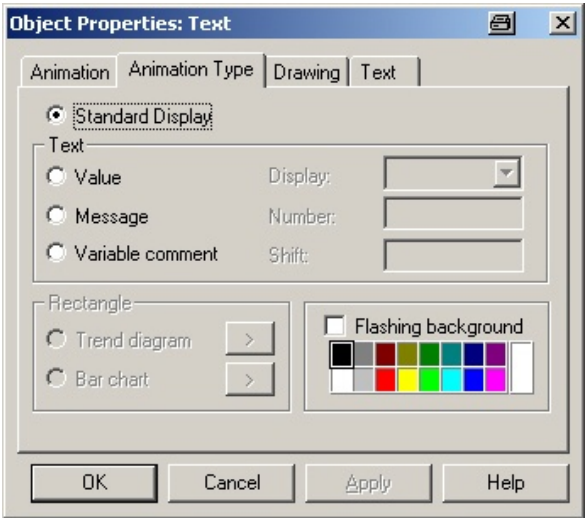
1	<p>The operator screen is used to animate graphic objects that symbolize the application.</p> <p>Select the New screen menu command under Operator Screens to create a new operator screen.</p>	
2	<p>Enter the name of the operator screen in the Name field of the properties window that opens.</p> <p>Click OK to display the empty operator screen.</p>	

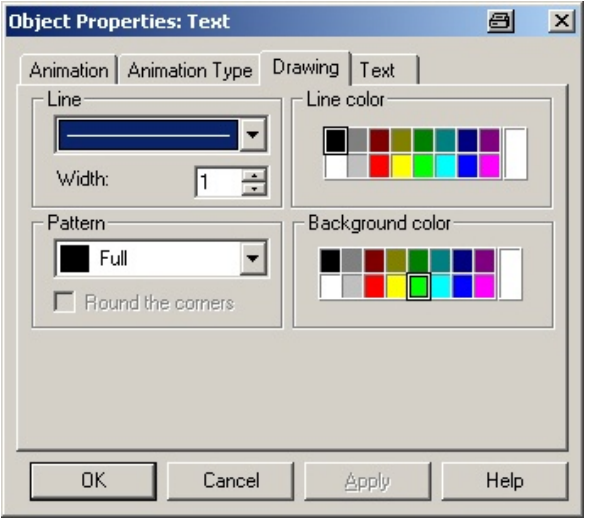
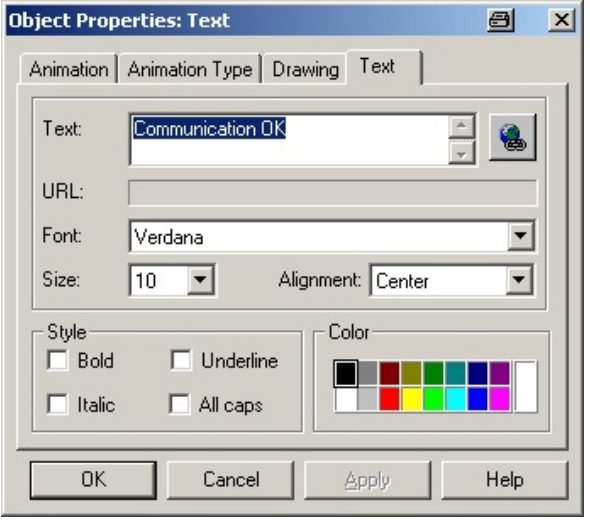

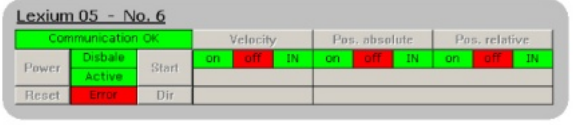
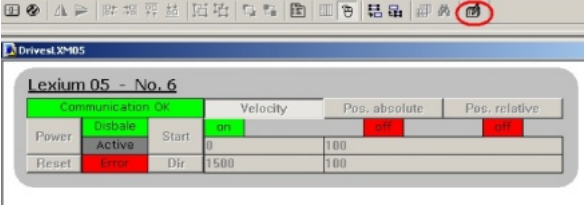
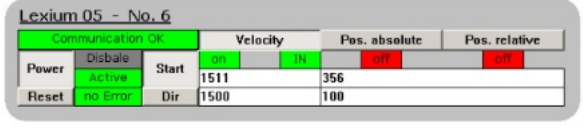
3	The various elements are available in the toolbar .	
4	Select the Text element and then specify the text position and area.	
5	<p>The animation is enabled by checking the Animated Object box on the Animation tab of the properties window.</p> <p>Enter the Variable.</p> <p>In this case, the text is only visible if Bit = 1 is selected.</p>	
6	Select Standard Display on the Animation Type tab.	



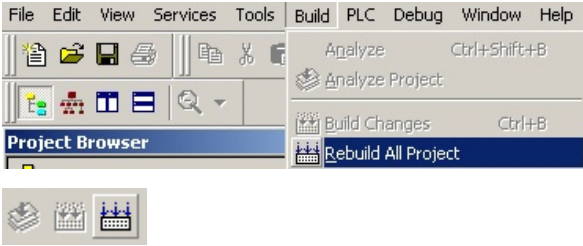
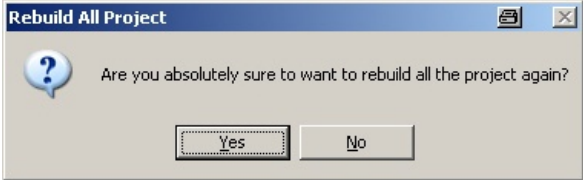
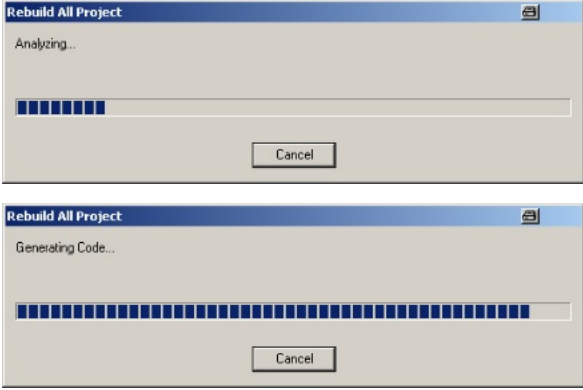
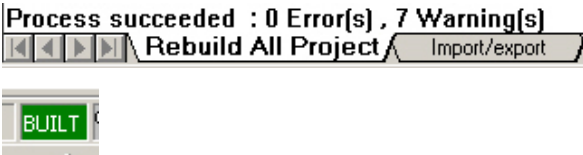

7	Line and field properties can be specified on the Drawing tab.	
8	Both the text itself and its properties are displayed on the Text tab.	
9	The text now appears as follows:	
10	The screenshot opposite shows the control settings for a Lexium 05 servo drive. Unity is currently not connected to the PLC.	
11	If a connection to the PLC is established (Online), the elements are animated. To operate objects in online mode, you must click the circled symbol .	
12	The view shown here displays the elements that can be operated.	

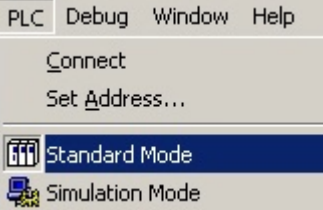

Building a Project

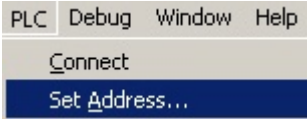
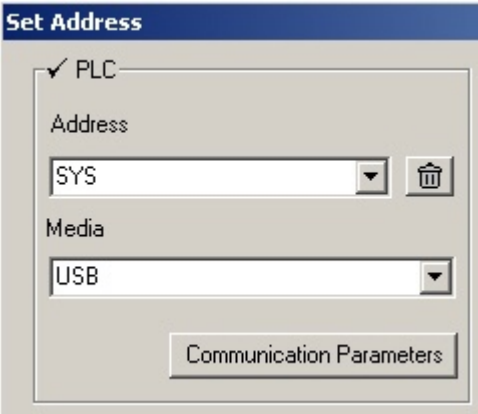
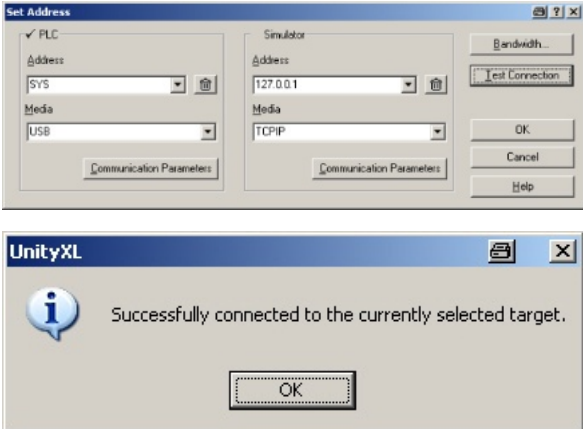

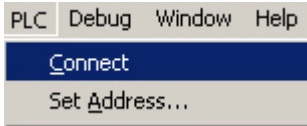

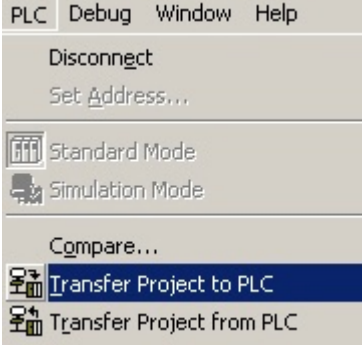
<p>1</p>	<p>A project must be analyzed and compiled before it can be transferred to the PLC.</p> <p>To do this, select Build and Rebuild All Project in the menu bar.</p> <p>Alternatively, click the corresponding icon in the toolbar.</p>	
<p>2</p>	<p>Click Yes to confirm the message that follows.</p>	
<p>3</p>	<p>The project is analyzed and the code generated.</p>	
<p>4</p>	<p>Once this is complete, the number of errors and warnings is displayed.</p> <p>A box displaying BUILT can also be seen in the bottom right-hand corner of the Unity window.</p>	

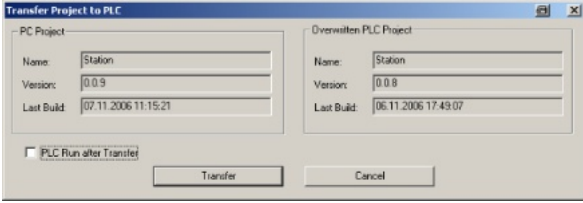
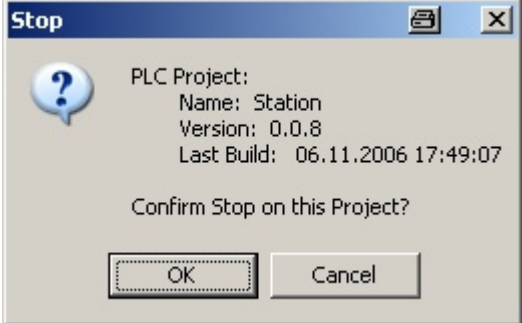
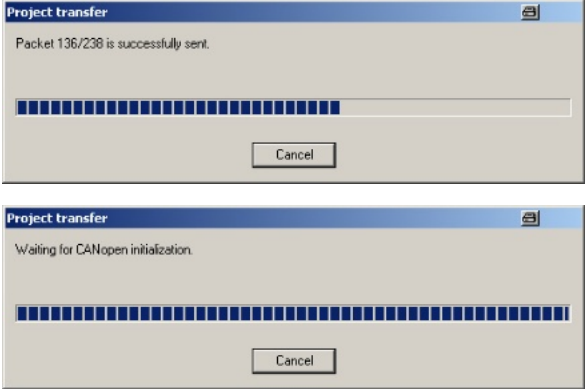
Connecting the PC to the PLC and Transferring a Project

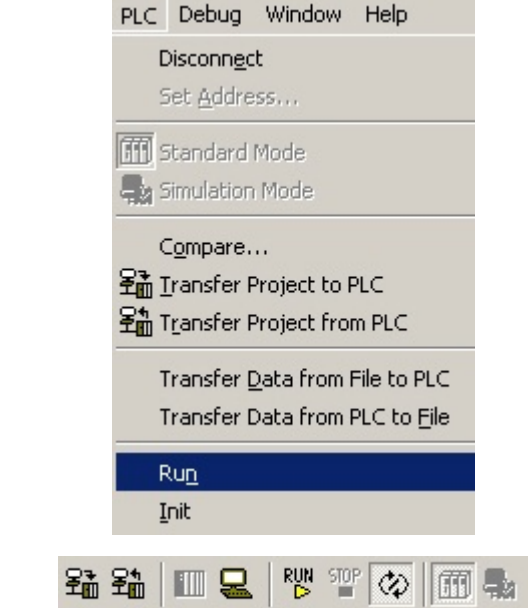
<p>1</p>	<p>To establish a connection to the PLC, Standard Mode must first be activated.</p>	
<p>2</p>	<p>If the PLC is connected to the PC via the USB cable, an icon indicating this will be displayed in the PC status bar.</p> <p>The Modicon M340 – BMX CPU is displayed in the Windows screen.</p>	

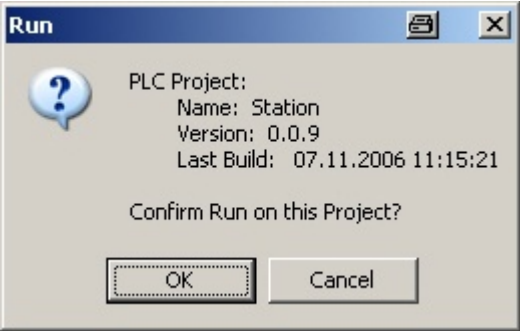
3	Select PLC->Set Address to set the address.	
4	<p>The following parameters are set for a USB connection:</p> <p>Address: SYS Media: USB</p>	
5	<p>These entries can be tested directly. To do this, click Test Connection on the right-hand side.</p> <p>A message window will appear to indicate that connection has been successful. Click OK to confirm.</p> <p>Close the Set Address window by clicking OK.</p>	
6	In Unity Pro, the mode of connection that has been selected is displayed in the status bar at the bottom.	
7	Select PLC->Connect to connect to the PLC.	
8	The status bar shows that the PLC status is set to RUN and that the current program is not the same as the one in the PLC (DIFFERENT).	
9	<p>Select:</p> <p>PLC->Transfer Project to PLC</p> <p>to download the project.</p>	

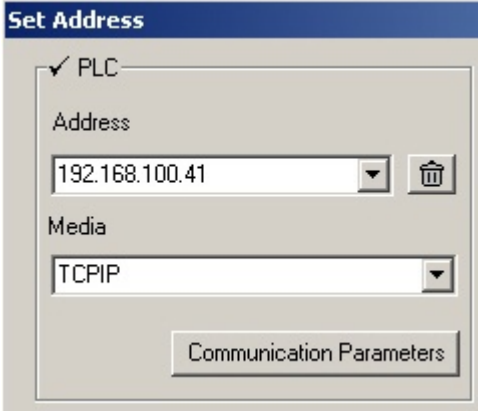
10	<p>Both the PC and PLC projects, along with their version and date, are displayed in the window that opens next.</p> <p>Click Transfer to start the download process.</p>	
11	<p>The project running on the PLC must be stopped.</p> <p>Click OK to continue.</p>	
12	<p>The project is transferred and the CANopen bus initialized.</p>	
13	<p>The status bar shows that the project is the same (EQUAL), but that it is still in STOP status.</p>	
14	<p>Select PLC -> Run to start the program.</p>	

15	Click OK to confirm.	 <p>The 'Run' dialog box shows the following information: PLC Project: Name: Station, Version: 0.0.9, Last Build: 07.11.2006 11:15:21. It asks 'Confirm Run on this Project?' and has 'OK' and 'Cancel' buttons.</p>
16	The project begins to run.	 <p>The status bar shows 'HMI R/W mode' with 'EQUAL' and 'RUN' buttons highlighted in green, followed by 'UPLOAD INFO OK' and 'USB:SYS'.</p>
17	<p>If an IP address has been configured, it can be used to establish a connection between the PC and PLC.</p> <p>To do this, enter the IP address in the Address field in the Set Address window, and select TCPIP under Media.</p>	 <p>The 'Set Address' dialog box shows 'PLC' checked. The 'Address' field contains '192.168.100.41' and the 'Media' dropdown is set to 'TCPIP'. A 'Communication Parameters' button is at the bottom.</p>
18	The IP address is displayed in the status bar.	 <p>The status bar now shows 'HMI R/W mode' with 'EQUAL' and 'RUN' buttons highlighted in green, followed by 'UPLOAD INFO OK' and 'TCPIP:192.168.100.41'.</p>

Exporting and Archiving a Project

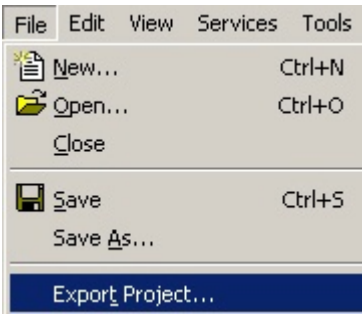
1	<p>The following are exported as part of a project export:</p> <ul style="list-style-type: none"> • Input/output configuration • Sections • SR program modules • Event processing • Unprotected DFB types • DDTs • Variables • Animation tables • References to protected DFB types <p>To perform an export, select File -> Export Project via the menu bar.</p>	 <p>The 'File' menu is shown with options: New... (Ctrl+N), Open... (Ctrl+O), Close, Save (Ctrl+S), Save As..., and Export Project... (highlighted).</p>
---	---	--

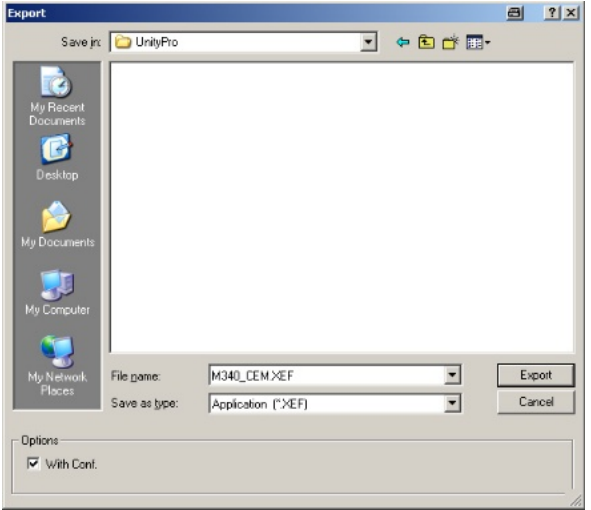
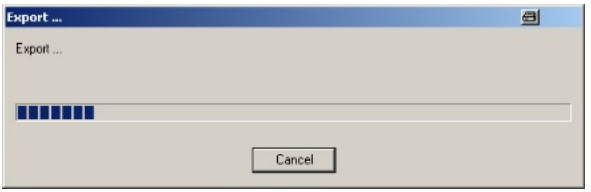
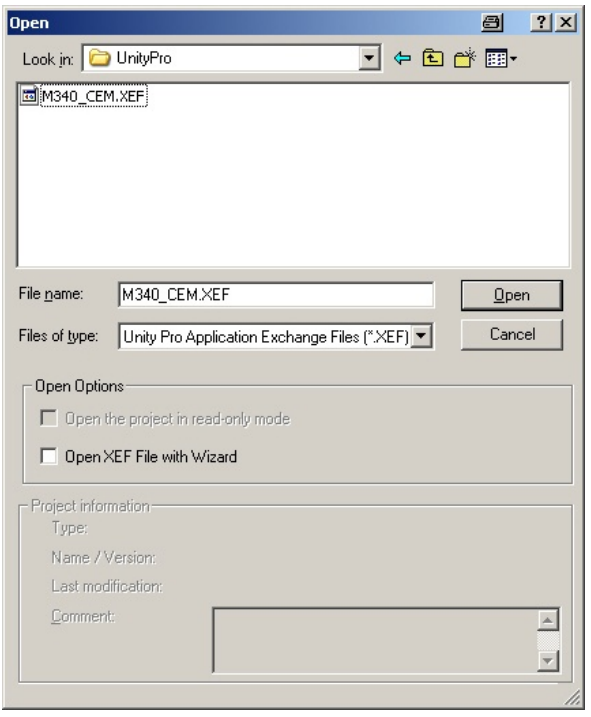
<p>2</p>	<p>When a project is exported, the software generates a *.XEF file.</p> <p>You can select any location in which to save the file and any file name.</p> <p>Click Export to begin exporting.</p>	
<p>3</p>	<p>The project is exported. The progress bar is displayed.</p>	
<p>4</p>	<p>An exported project can be opened directly with Unity Pro.</p>	
<p>5</p>	<p>As well as the XEF export file and the STU project file, there is an STA project archive.</p> <p>The properties of the STA file are as follows:</p> <ul style="list-style-type: none"> • The STA file is highly compressed (around 50 times more than the STU file). It is used to transfer projects to networks (e.g, local or Internet networks). • The STA file can be used to transfer projects between different versions of the Unity Pro software. • The STA file contains the entire project: <ul style="list-style-type: none"> - The PLC binary files - The read-out information Comments and animation tables - The operator screen 	

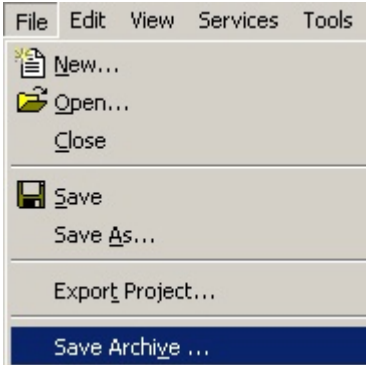
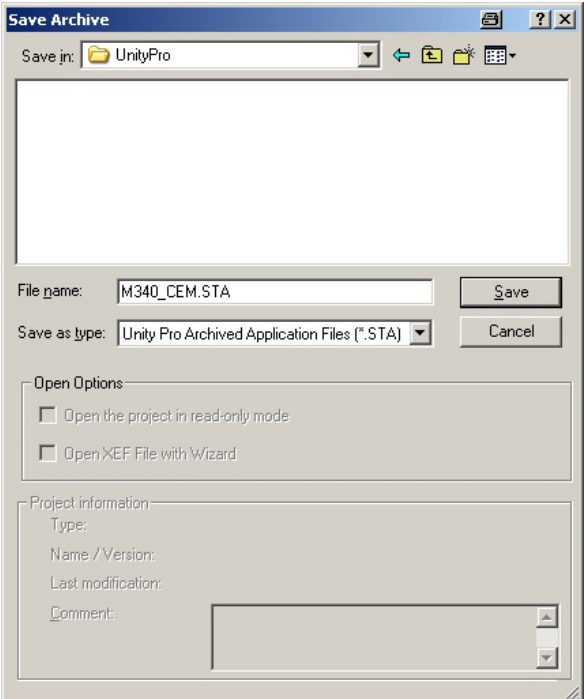
<p>6</p>	<p>If an STA file is selected, the software offers a certain amount of information:</p> <ul style="list-style-type: none"> • Project name • Accompanying comment • Version and date of project generation • The project's target PLC • The date when the source code was last changed. • The version of Unity Pro used to generate this archive. <p>Select File->Save Archive via the menu bar.</p>	
<p>7</p>	<p>Select the location for saving the file and the file name.</p> <p>Click Save to begin archiving.</p>	

HMI

Introduction

This application features a Magelis XBT-GT 2330 HMI, which is connected to the PLC via the Modbus TCP/IP protocol.

Vijeo Designer software is used to program and configure the terminal. The steps to be taken in order to create and download a program are described on the pages that follow.

Setting up the HMI is done as follows:

- Vijeo Designer function overview
- Create new project (specify platform, hardware, communication).
- Communication settings
- Create new variables
- Create screens
- Display error message
- Check the project and download it
- Application overview

Function Overview

<p>1 The Vijeo Designer environment consists of the following elements:</p> <ol style="list-style-type: none"> 1 Navigator 2 Information display 3 Inspector 4 Data list 5 Feedback area 6 Toolbox 	
--	--

Creating a New Project

<p>1 After starting Vijeo Designer, a new project can be created. To do this, select,</p> <p>File -> New Project</p> <p>in the menu bar.</p>	
--	--

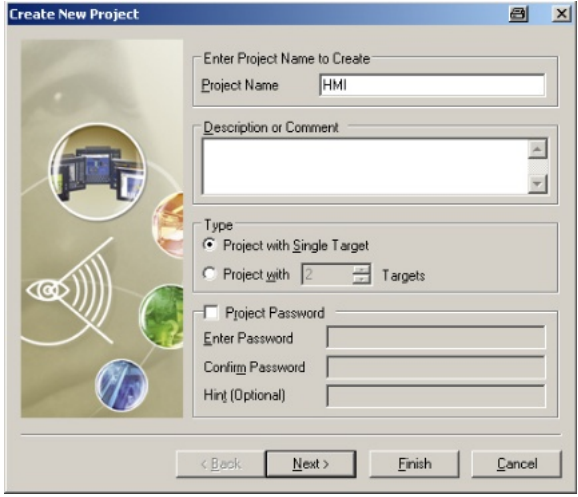
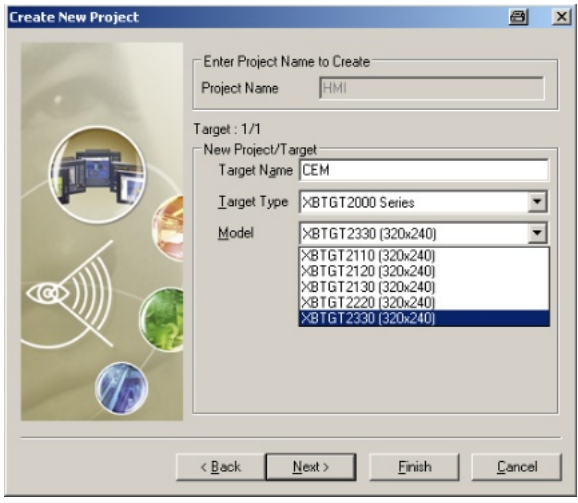
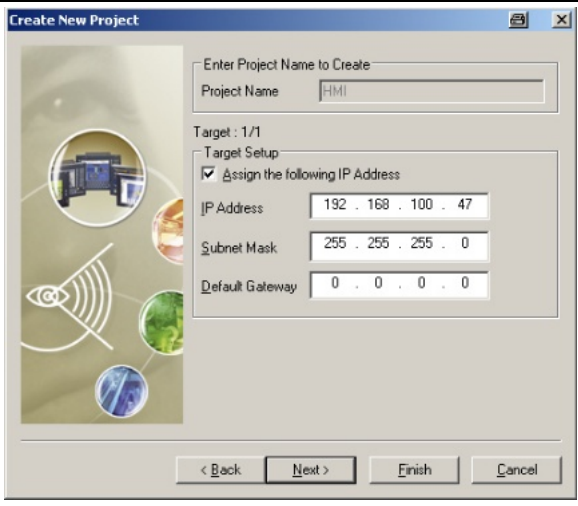

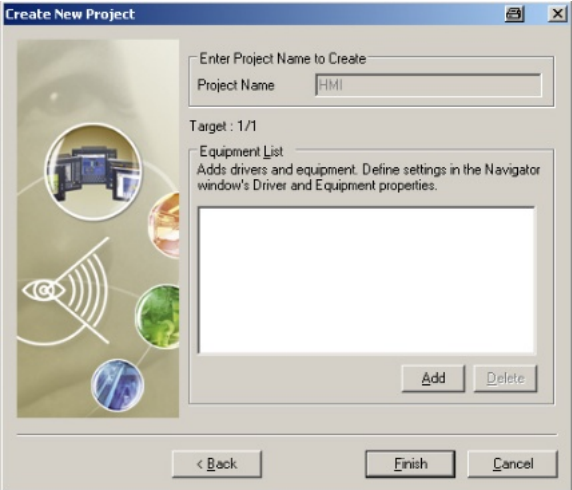
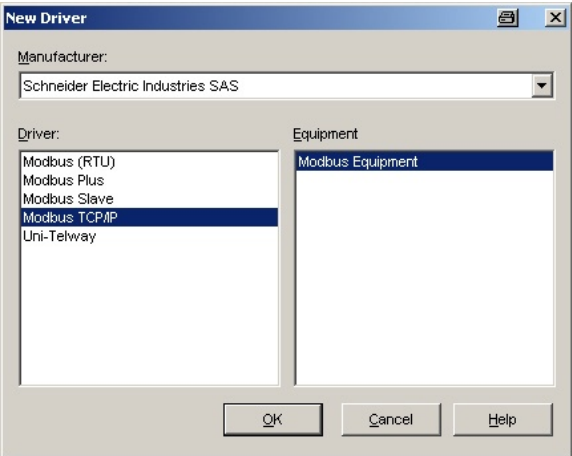
<p>2</p>	<p>Enter a Project Name for the application and a comment (optional).</p>	
<p>3</p>	<p>Next, select the target device used and enter a logical name.</p> <p>Example project:</p> <p>Target Name: CEM</p> <p>Target Type XBTGT 2000</p> <p>Model: XBTGT2330</p>	
<p>4</p>	<p>In order to use the device's Ethernet interface, you need to enter the IP Address, Subnet Mask and, if applicable, the Default Gateway.</p>	

<p>5</p> <p>In order to be able to exchange data with other devices, the Magelis HMI requires a communication driver.</p> <p>To set one up, click Add.</p>	
<p>6</p> <p>Start by selecting Schneider Electric Industries SAS from Manufacturer list.</p> <p>For communication with the PLC, select Modbus TCP/IP in the Driver list and Modbus Equipment under Equipment.</p> <p>Once you have selected a communication driver, you can complete the creation of the new project by clicking OK followed by Finish.</p>	

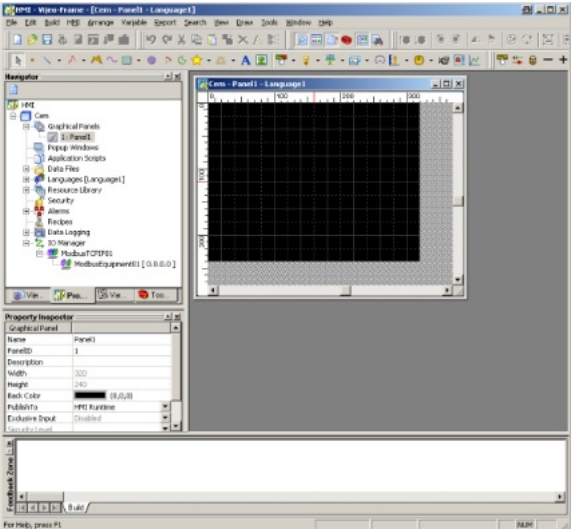
Communication Settings

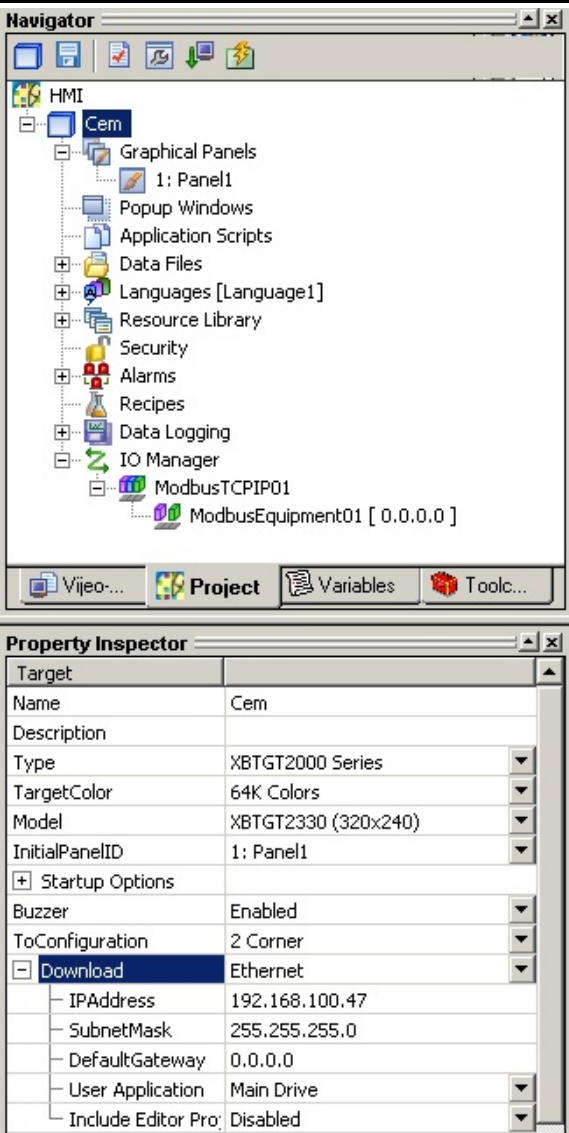
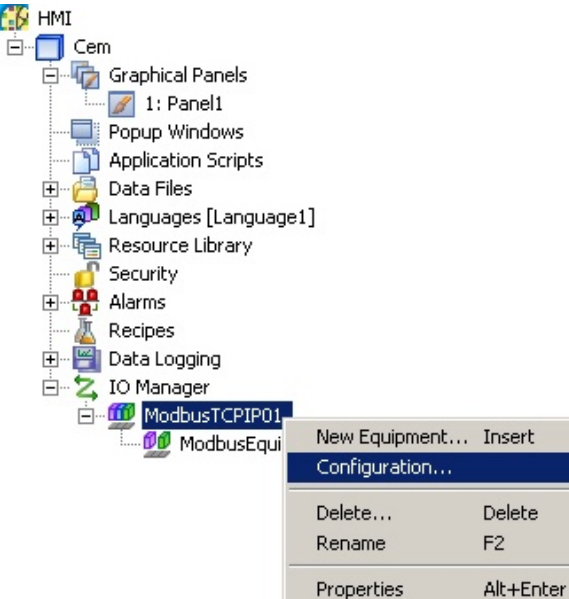
<p>1</p> <p>Once you have created the project, Vijeo Designer will display the workspace described above with an empty edit screen on the right-hand side.</p>	
---	--

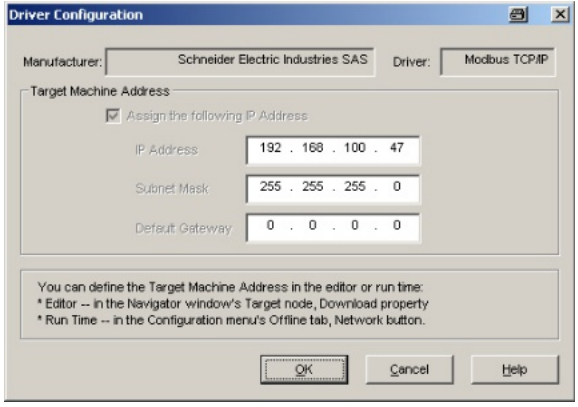
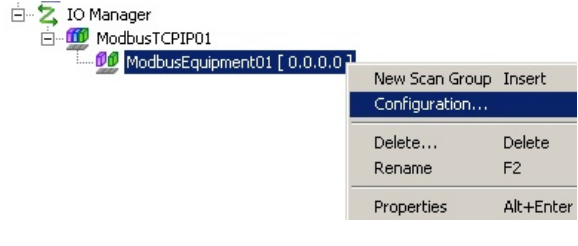
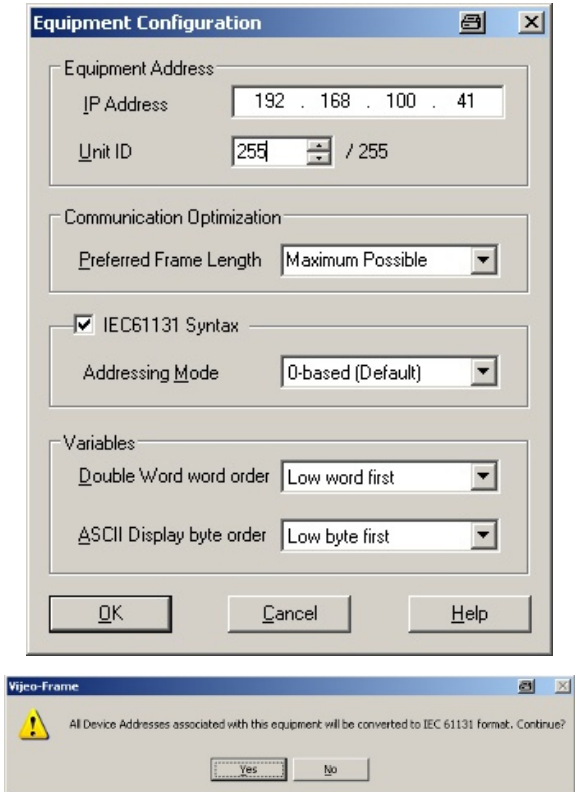
<p>2</p> <p>It is possible to change the settings for downloading the project to the HMI.</p> <p>To do this, click the target in the Navigator (in this case, Cem) and select Download in the Property Inspector.</p> <p>In order that the project can be transferred to the Magelis HMI, you will need to select Ethernet as well as the IPAddress and the SubnetMask of the HMI.</p>	 <p>The screenshot shows two windows. The top window is the 'Navigator' showing a tree view under 'HMI' with 'Cem' selected. Below it is the 'Property Inspector' window. The 'Target' is 'Cem'. The 'Download' section is expanded to 'Ethernet', showing fields for 'IPAddress' (192.168.100.47) and 'SubnetMask' (255.255.255.0).</p>
<p>3</p> <p>The interface parameters must be declared to the Modbus TCP/IP driver for communication with the PLC.</p> <p>Right-click ModbusTCPIP01 and select Configuration....</p>	 <p>The screenshot shows the 'Navigator' window with 'ModbusTCPIP01' selected. A context menu is open over it, with 'Configuration...' highlighted. Other options include 'New Equipment...', 'Delete...', 'Rename', and 'Properties'.</p>

<p>4</p>	<p>The IP address of the HMI is displayed here.</p>	
<p>5</p>	<p>For the equipment configuration, right-click ModbusEquipment01 and select Configuration....</p>	
<p>6</p>	<p>Enter the IP Address of the PLC here.</p> <p>Under Communication Optimization, select Maximum Possible.</p> <p>Following this, activate the IEC Syntax and set the addressing mode to 0-based (Default). This means that the same addressing is used as in the PLC (%MWxxx).</p> <p>Click Yes to confirm the message that appears.</p>	
<p>7</p>	<p>Right-click and select Rename to change the default names as follows:</p> <p>Change ModbusTCPIP01 to HMI</p> <p>Change ModbusEq. to PLC</p>	

Creating Variables

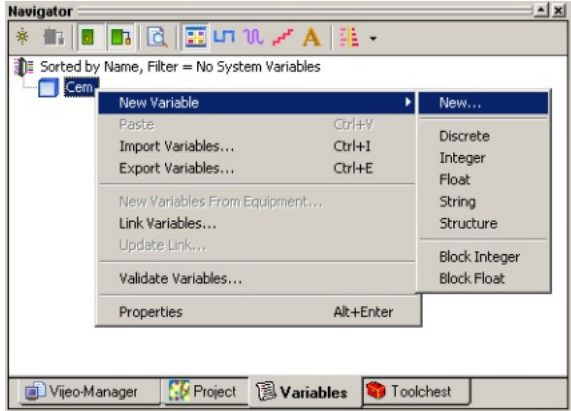
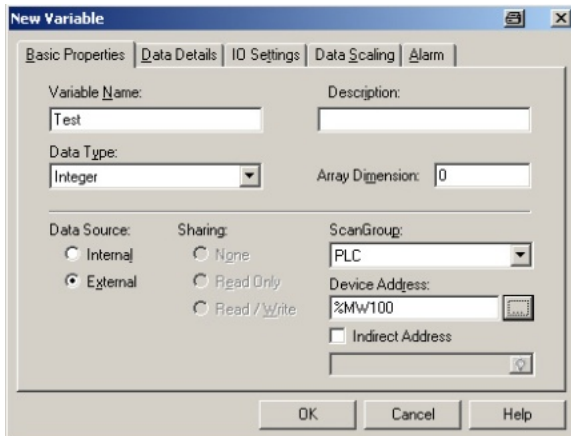
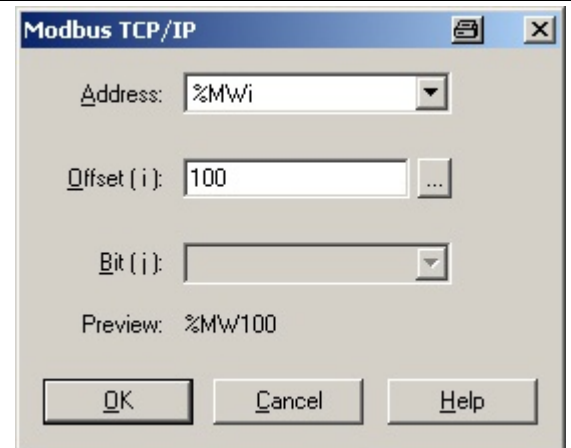
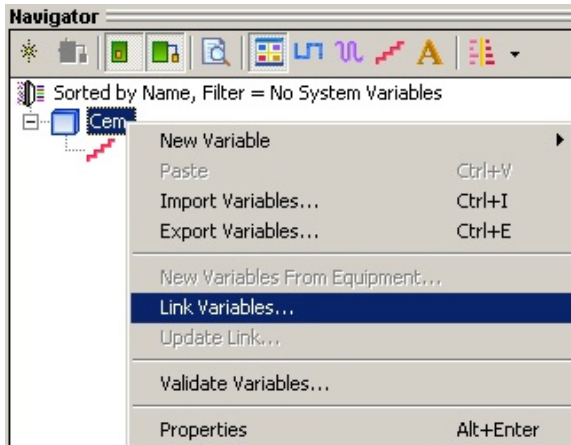
<p>1</p>	<p>To create new variables in the Navigator, select the Variables tab at the bottom of the screen.</p> <p>Right-click the project name to access a popup menu and select</p> <p>New Variable→New....</p>	
<p>2</p>	<p>To create variables, the following information must be entered:</p> <ul style="list-style-type: none"> • Variable Name • Data Type • Data Source (External) • Device Address in the PLC 	
<p>3</p>	<p>All PLC flags (located variables) can be addressed.</p> <p>Types that can be defined include flags (%M), words (%MW), double words (%MD) and floating points (%MF).</p> <p>All data to be displayed on the Viewer must be transferred to one of these types.</p>	
<p>4</p>	<p>It is also possible to both import and export variables. Another extremely convenient way of importing the PLC variables is to establish a direct connection to the PLC project.</p> <p>To do this, select the Link Variables option from the project name menu on the Variables tab.</p>	

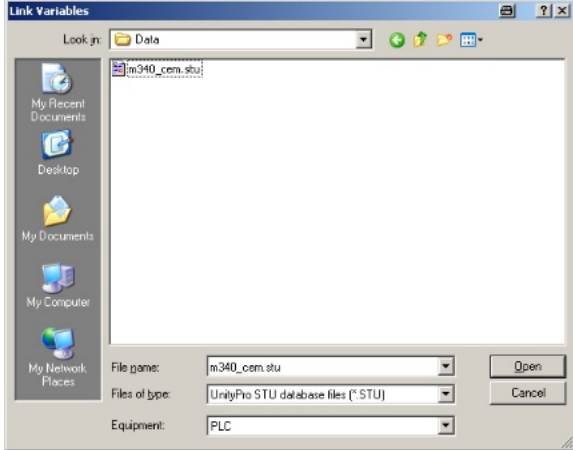
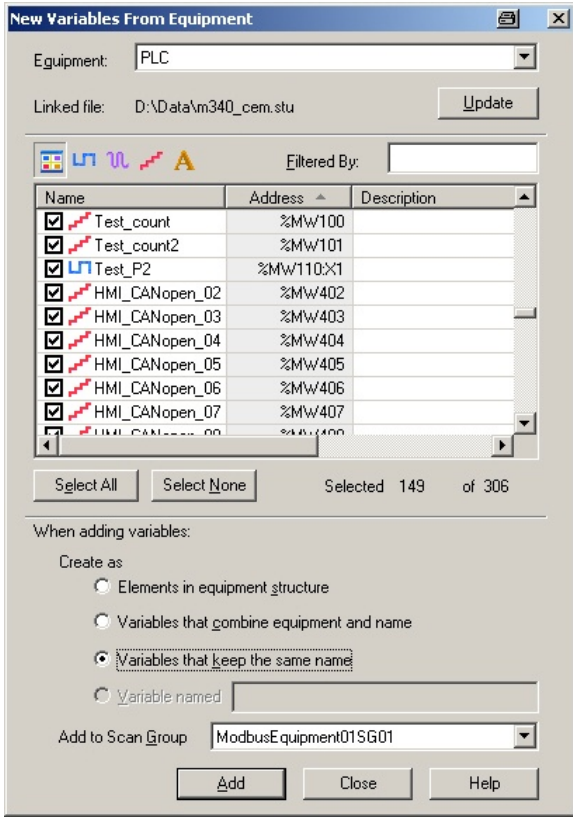
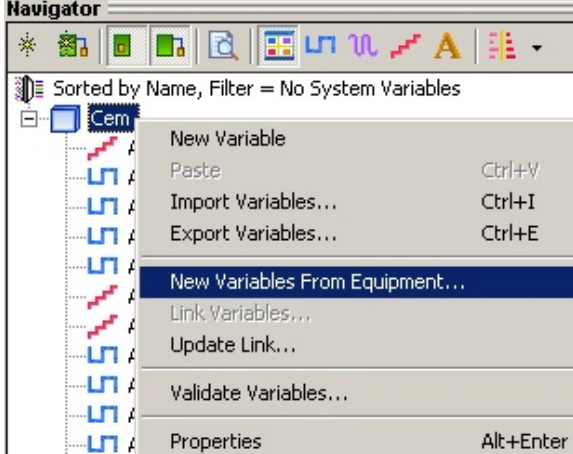
<p>5</p>	<p>Next</p> <p>select the file name/file.</p> <p>Files of type: Unity Pro (*.stu)</p> <p>Equipment: PLC</p> <p>Click Open to continue.</p>	
<p>6</p>	<p>All variables from the PLC project are displayed in this window with a name and address. The required variables can be selected by clicking the checkbox on the left-hand side.</p> <p>To make the connection between the PLC and HMI clear, the same variable names are used here. This option is set by selecting Variables that keep the same name.</p> <p>The selected variables are then transferred by clicking Add. Select Close to close the window.</p>	
<p>7</p>	<p>If other variables are required at a later point, it is possible to recall the window described above by selecting New Variables From Equipment.</p> <p>Update Link... can be selected to update the link in relation to the PLC file.</p>	

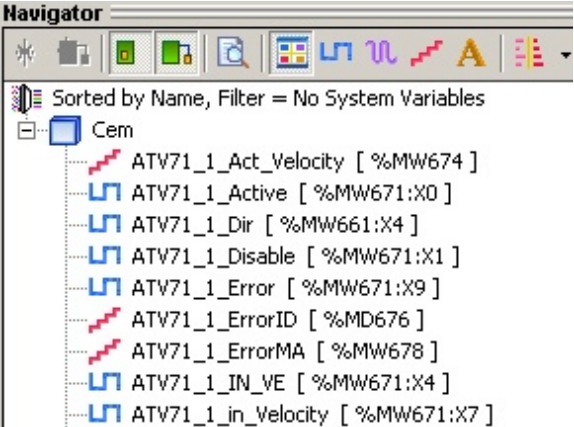
8	<p>The variables created are displayed in the Navigator, along with their names and addresses.</p>	
---	---	--

Creating Screens

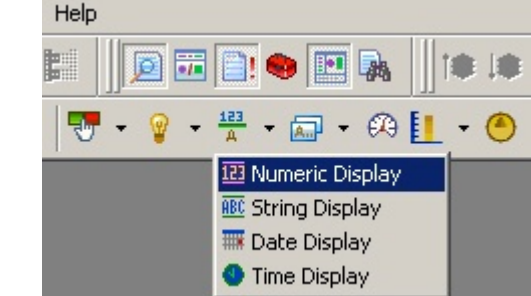
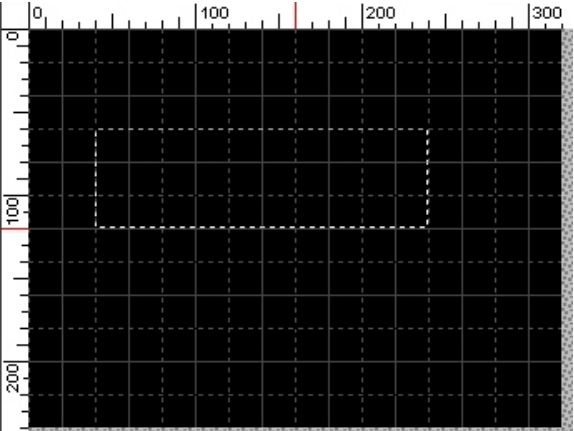
<p>The process for creating animations on screens will now be described using a numerical display. The functions are similar for other animation elements.</p>		
1	<p>Selection from the menu bar.</p> <p>Various icons and elements are available in the menu bar and the toolbox. Select Numeric Display</p>	
2	<p>First, define the position and size of the display area.</p>	

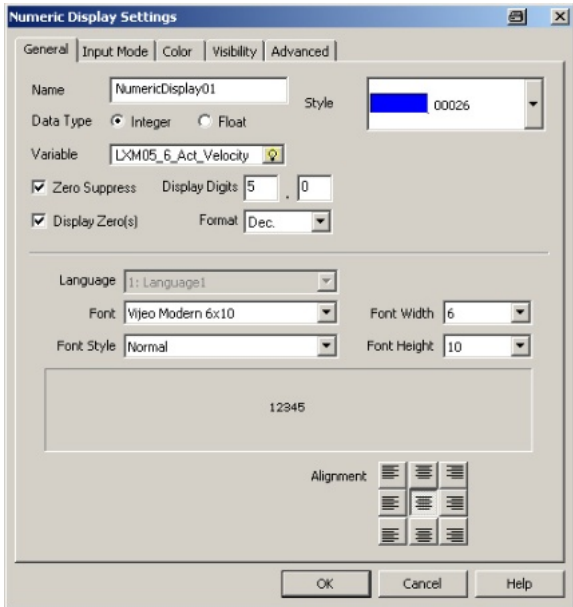
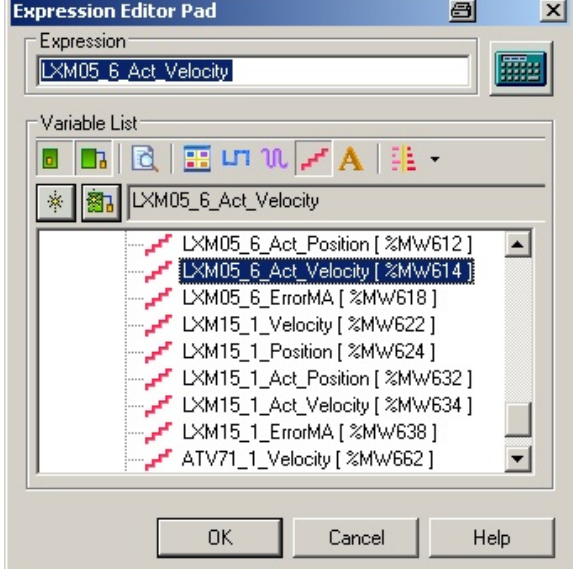
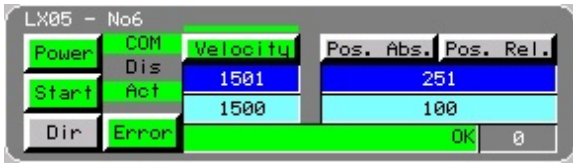
<p>3</p>	<p>Numeric Display Settings:</p> <ul style="list-style-type: none"> • Name • Data Type • Variable • Display Format • Font <p>The variable can be entered directly or can be selected by means of the icon to the right of the field (light bulb).</p> <p>Note:</p> <p>A variable name that has been entered but not recognized appears in red.</p>	
<p>4</p>	<p>The variable to be animated can be transferred from the list by double-clicking it.</p> <p>Additional functions, e.g., value inversion, can be executed by clicking on the calculator icon.</p>	
<p>5</p>	<p>The screenshot opposite (showing part of a complete screen) displays various animation elements.</p>	

<p>6</p>	<p>Property Inspector</p> <p>Each animation element on the screen has its own properties which can be viewed in the Property Inspector (right-click on the object).</p> <p>The property Inspector lists all settings associated with the element and they can be modified.</p>	
-----------------	---	--

Displaying an Error Message

<p>1</p>	<p>In the PLC, servo drive error messages can be displayed as a number from 0 to 16.</p> <p>However, this needs to be displayed as text on the HMI.</p> <p>For this purpose, it is possible to select and position the Message Display.</p>	
-----------------	--	--

2 To begin making the settings, select the **Variable**.

Also enter:

States: **17**

Then click the **New Resource** icon (to the right of the **Color Resource** field).

Note:

On the **I/O Settings** tab in **Variable Properties**, **BIN** must be selected as **Data Format** and **16 bits** as **Data Length**.

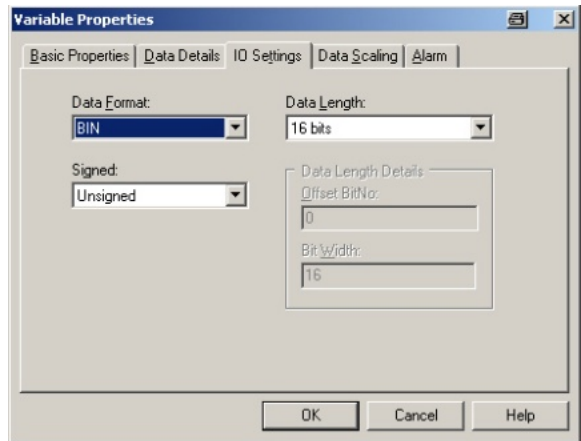
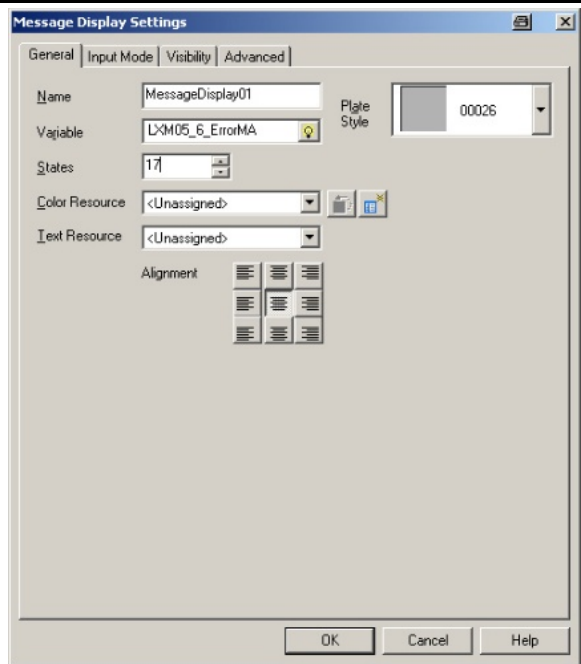

3 In the New Resource window, enter the following:

Color Name: **ErrorColor**

Text Name: **ErrorText**

No. of States **17**

Select **Message Display**.

Data Type: **Integer**

Finally, click **OK** and **Yes**.

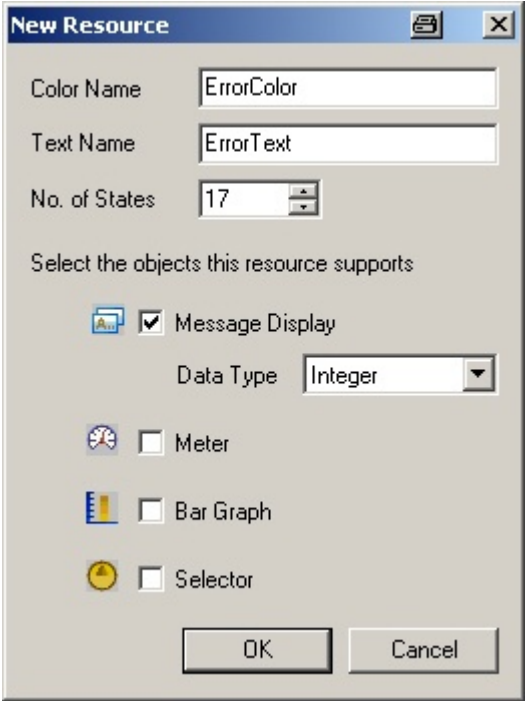
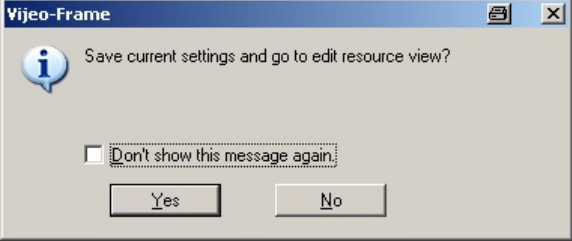

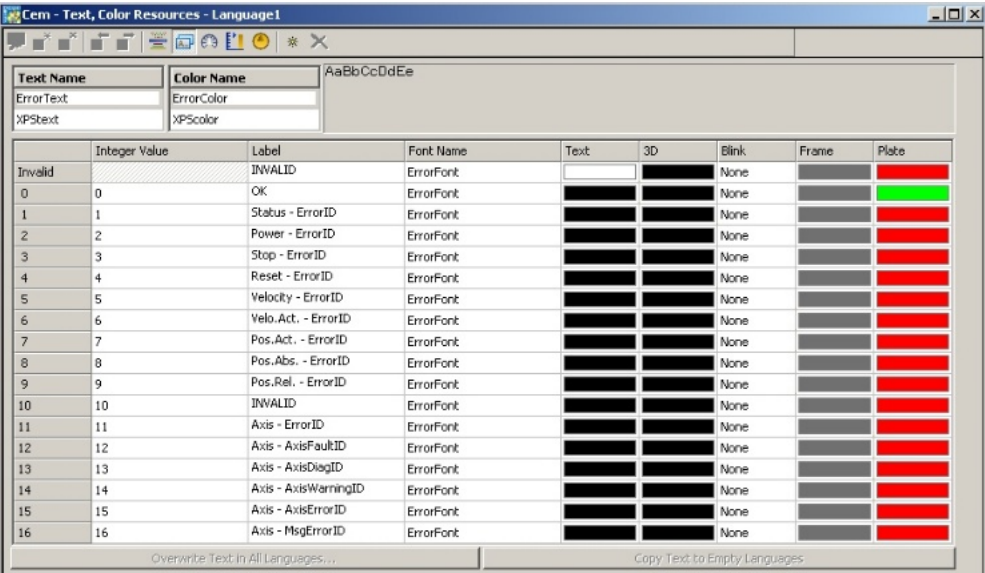

4 In the following table, a **Label** and **Font Name** can be entered for each **Integer Value** (0 – 16).

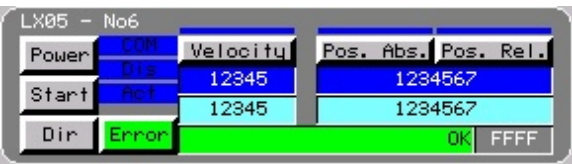

Integer Value	Label	Font Name	Text	3D	Blink	Frame	Plate
Invalid	INVALID	ErrorFont			None		
0	OK	ErrorFont			None		
1	Status - ErrorID	ErrorFont			None		
2	Power - ErrorID	ErrorFont			None		
3	Stop - ErrorID	ErrorFont			None		
4	Reset - ErrorID	ErrorFont			None		
5	Velocity - ErrorID	ErrorFont			None		
6	Velo.Act. - ErrorID	ErrorFont			None		
7	Pos.Act. - ErrorID	ErrorFont			None		
8	Pos.Abs. - ErrorID	ErrorFont			None		
9	Pos.Rel. - ErrorID	ErrorFont			None		
10	INVALID	ErrorFont			None		
11	Axis - ErrorID	ErrorFont			None		
12	Axis - AxisFaultID	ErrorFont			None		
13	Axis - AxisDiagID	ErrorFont			None		
14	Axis - AxisWarningID	ErrorFont			None		
15	Axis - AxisErrorID	ErrorFont			None		
16	Axis - MsgErrorID	ErrorFont			None		

5 The message display appears on the screen, e.g. on the screen for displaying a Lexium 05 error.



6	The appropriate output text will then appear during operation according to the error number.	
---	--	--

Downloading the Project

1	<p>Before being downloaded to the HMI, the project must first be analyzed.</p> <p>To do this, select Validate All from the Build menu.</p> <p>The results are listed in the Feedback Zone.</p>	
2	If Build All is selected instead, the messages are still listed in the Feedback Zone .	
3	<p>Select Download All under Build to transfer the application to the connected Magelis terminal.</p> <p>The configured method of communication (in this case, Ethernet) is used.</p>	

4	<p>Assigning the Ethernet IP Address</p> <p>Unless the project has already been transferred using a USB cable, the HMI will not have the correct IP address. For this reason, the IP address must be entered via the offline setting mode before downloading takes place.</p> <p>This is called up as follows:</p> <ul style="list-style-type: none"> • On powering up, touch the top left-hand corner of the screen. • Alternatively, while the application is being executed, touch three corners of the screen at the same time. (In the platform properties of the Vijeo Designer Editor, you can select the procedure to be followed by your application.) • Next, enter the IP address. • Switch back to online mode.
----------	---

Application Overview

1	<p>The example application features a number of displays that can be selected by the user.</p> <p>The structure is mapped on the welcome screen. Manual operation mode is set by default. There are no logic configuration settings in the PLC for automatic mode.</p> <p>All drives can run in manual mode, controlled directly via the display. To do this, you must switch to the relevant screen.</p> <p>The HMI configuration screen can be reached via System (in the lower right-hand corner of the screen).</p>	
2	<p>The header on subsequent screens is identical and provides information about the status of the machine.</p> <p>If a CANopen bus node is faulty, this will be indicated in the header under Bus. Switch to the Bus screen to identify the node. More information can be accessed by pressing Detail.</p>	

<p>3</p>	<p>A summary of the individual alarms is provided on the Alarm screens. In the header, the Alarm field is a group message.</p>	
<p>4</p>	<p>Safety controller messages are displayed on the Safety screen. The two Emergency Stop buttons are displayed along with their inputs and the two outputs. The details provide information about the status, mode, outputs, inputs and diagnosis.</p>	

<p>5</p>	<p>The screenshot opposite shows two Lexium 15 drives. Each operation mode (velocity, absolute positioning and relative positioning) has a button for selecting it. The drive is activated by means of Power. The operation mode is triggered using Start. The direction is set using Dir (in Velocity mode only). An error message is acknowledged by means of Error. Both the setpoint speed and setpoint position can be set using a virtual keypad.</p> <p>The status message (COM = Communication, Dis = Disabled and Act = Active), the display of the actual speed and actual position, and the error message all act as feedback.</p>	
<p>6</p>	<p>The corresponding screen for the six Lexium 05 drives appears opposite (3 screens for every 2 drives).</p>	
<p>7</p>	<p>Control of the six Altivar 71 variable speed drives is the same as the lexium 05 but has no positioning function. The other control elements remain the same.</p>	

8 The two TeSysU motor starters can be switched on and off using Start. The status is displayed by means of the status elements.

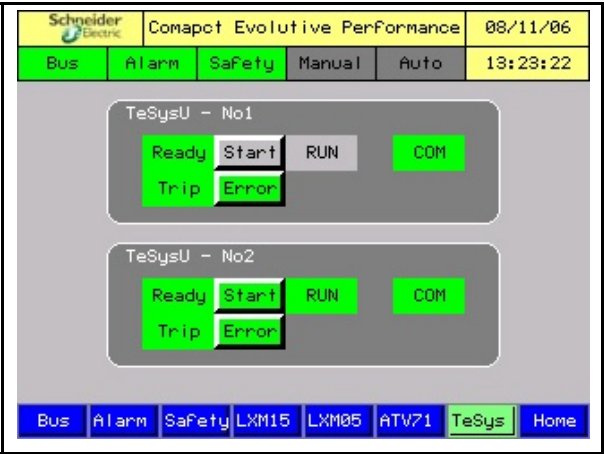

Devices

Introduction

This chapter describes the steps required to initialize and configure the devices to attain the described system function.

General

The following devices are used:

- **Safety controller**

Using the **XPSMCWN** software, the XPSMC safety controller can be configured, started and diagnosed with the aid of a PC. The straightforward user interface facilitates configuration of the XPSMC for a variety of different applications.

- **Lexium 15**

The Lexium 15 LP servo drives are parameterized using the **UniLinkL** software.

With its graphical user interface and Windows dialog boxes, UniLink provides an easy way of configuring parameters for one or more axes.

- **Lexium 05 and Altivar 71**

The Lexium 05 servo drives and the Altivar 71 variable speed drive can be set up via the front operator panel. You also have the option of using the **PowerSuite** software. The advantages of using PowerSuite are that you

- Can save the data on your PC and copy it as you wish
- Can print out the documentation *and*
- Can be assisted in optimizing the parameters online.

- **TeSysU**

The TeSysU motor starter consists of a power base, control unit and communication module. No software is required for parameterization.

Safety controller

Introduction

This chapter describes how to parameterize and transfer programs to the safety controller.

The safety controller permits autonomous control (processing) of safety functions. These functions are integrated in the APSMCWIN software and simply need to be parameterized.

Preconditions



Before carrying out the steps described below, you must ensure the following:

- That the XPSMCWIN parameterization software is installed on your PC.
- That the XPSMC16ZC safety controller is connected to the power supply.
- That the PC is connected to the safety controller via the programming cable.

Proceed as follows to parameterize the safety controller:

- Begin configuration
- Create a new project and parameterize the communication
- Define the stop categories
- Add safety elements
- Save and check the project
- Load and start the controller
- Diagnostics function

Beginning Configuration

1	When Safety Suite starts up, the overview screen is displayed.	
2	From here, call the parameterization software by clicking the XPSMCWIN icon.	 <p>XPSMCWIN</p> <p>2.0</p>

3 When the XPSMCWIN software starts up, the user interface is displayed.

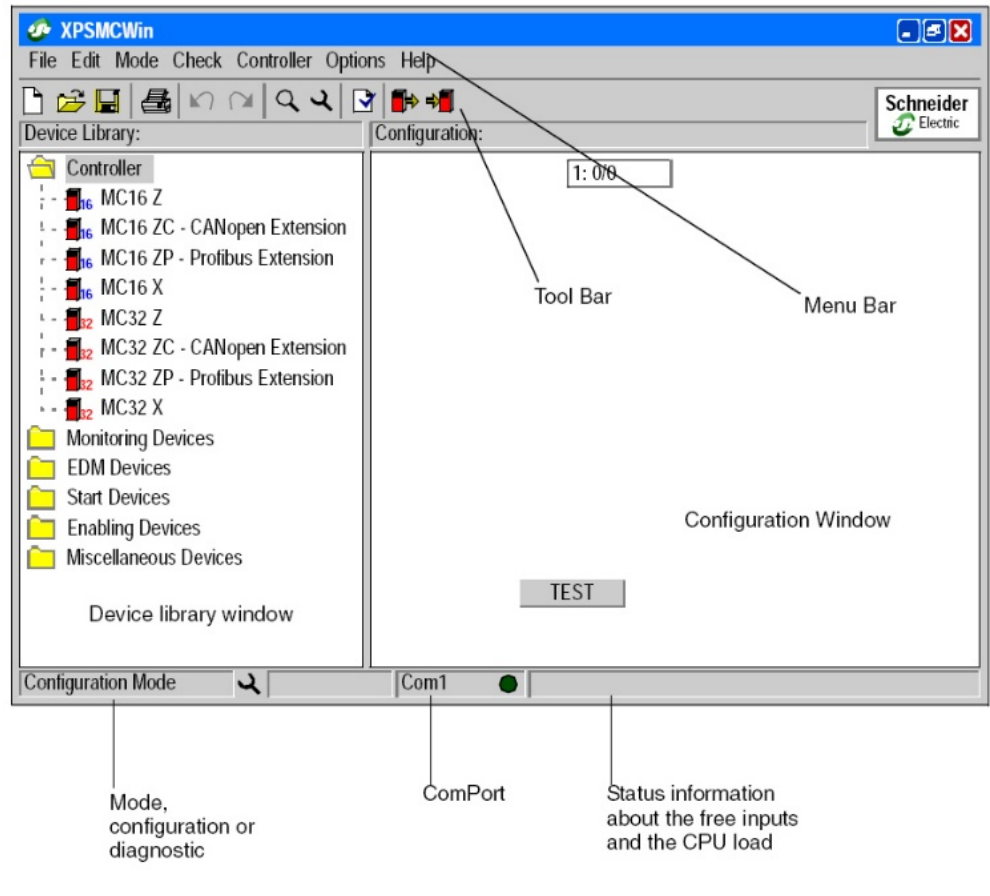

4 To establish a connection to the controller, the method of communication must be specified.

To do this, select **Controller** and **COM Selection...** in the menu bar.

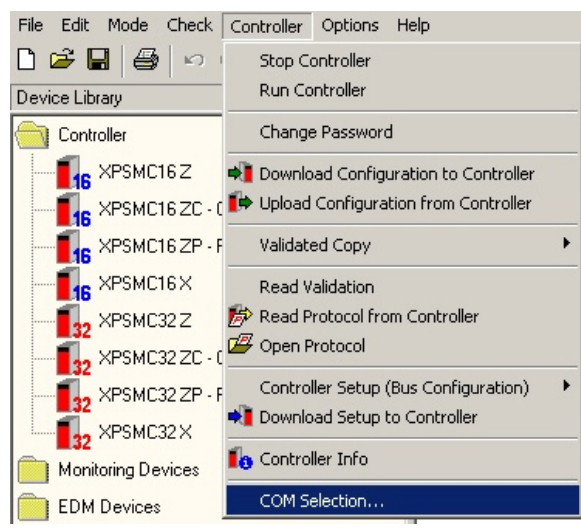

5 Select the **Serial Port** used for connecting the communication cable to the PC.

In this case, it is: **COM 1**.

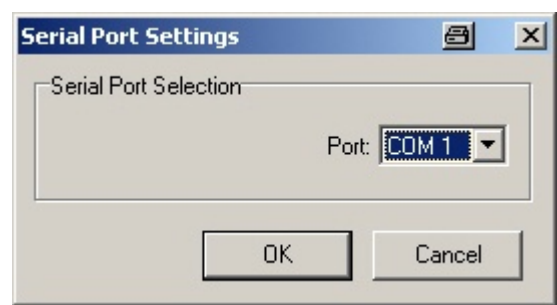

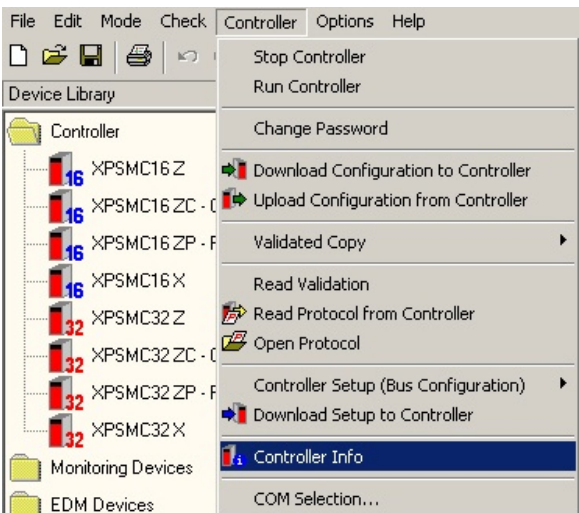
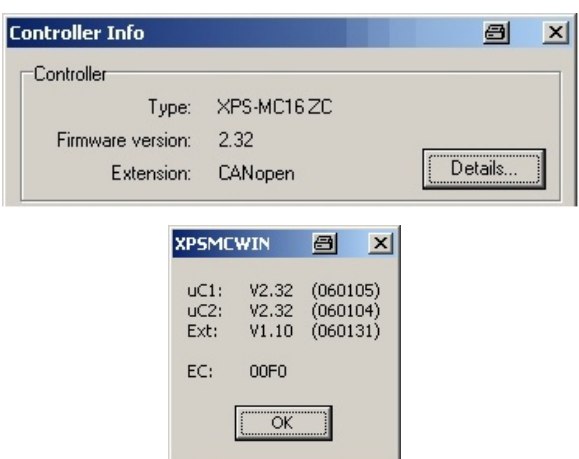
<p>6</p>	<p>To test the connection, your first option is to scan the controller status.</p> <p>To do this, select:</p> <p>Controller->Controller Info.</p>	
<p>7</p>	<p>In the Controller Info window, the Type, Firmware version and Extension are displayed.</p> <p>Further information can be obtained by clicking Details...</p>	

Creating a New Project and Parameterizing the Communication

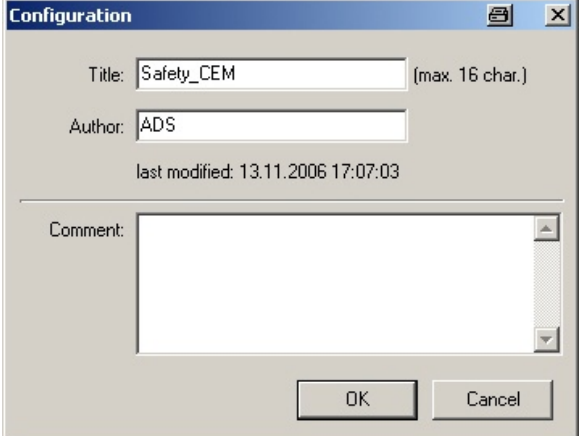
<p>1</p>	<p>Select File->New in the menu bar to create a new project.</p>	
<p>2</p>	<p>In the next window, enter the project name in the Title field.</p> <p>Additional data can be entered in the Author and Comment fields.</p> <p>Click OK to continue.</p>	

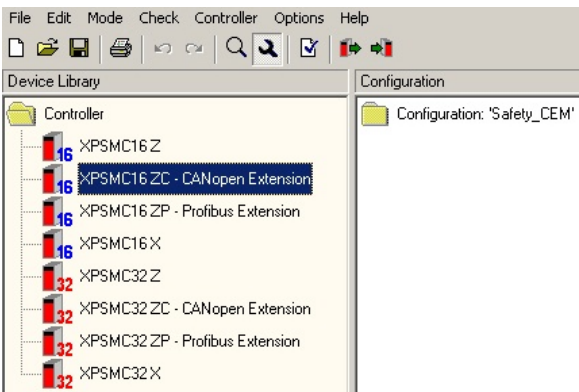
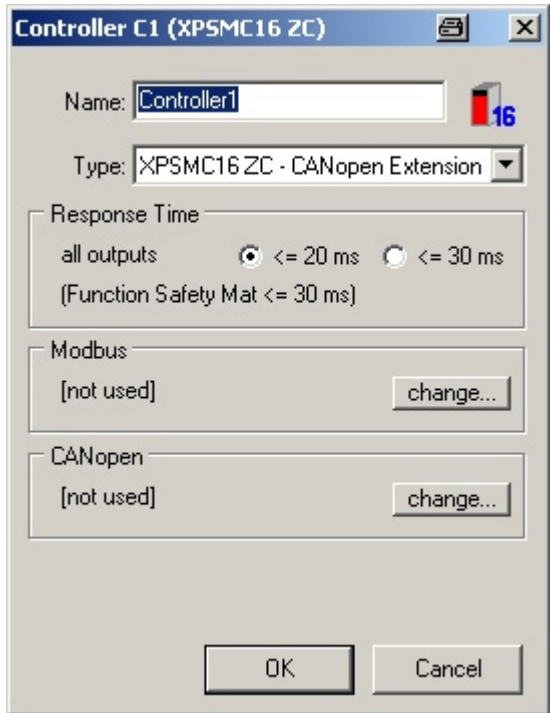
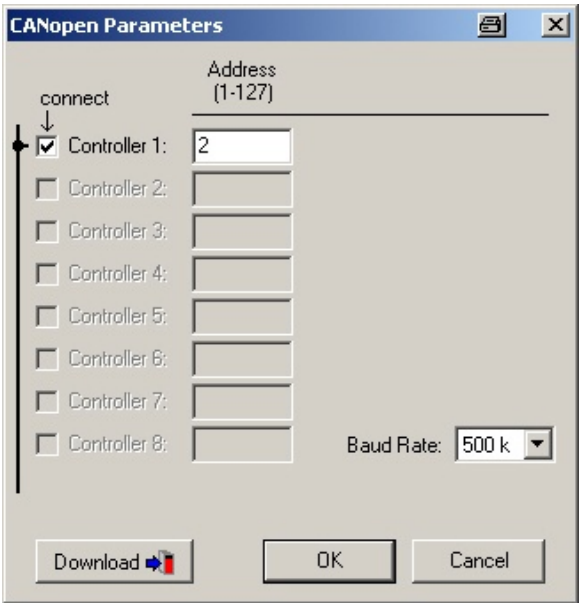
<p>3</p>	<p>In the Device Library window, you must then select the XPSMC16ZC safety controller with CANopen Extension under Controller.</p> <p>Press and hold down the mouse button to drag a copy into the Configuration window.</p>	 <p>The screenshot shows a software window with a menu bar (File, Edit, Mode, Check, Controller, Options, Help) and a toolbar. The 'Device Library' pane on the left lists various controllers, with 'XPSMC16ZC - CANopen Extension' highlighted. The 'Configuration' pane on the right shows a folder named 'Configuration: 'Safety_CEM''.</p>
<p>4</p>	<p>In the window that appears, it is possible to change the default name (Controller1).</p> <p>Click change... in the CANopen section to open the next window.</p>	 <p>The screenshot shows a dialog box titled 'Controller C1 (XPSMC16 ZC)'. It has a 'Name' field containing 'Controller1' and a 'Type' dropdown menu set to 'XPSMC16 ZC - CANopen Extension'. There are sections for 'Response Time' (with radio buttons for '<= 20 ms' and '<= 30 ms'), 'Modbus' (set to '[not used]'), and 'CANopen' (set to '[not used]'). Each of the last two sections has a 'change...' button. 'OK' and 'Cancel' buttons are at the bottom.</p>
<p>5</p>	<p>Here, you can define the CANopen parameters.</p> <p>For Controller 1, the following apply:</p> <p style="text-align: center;">Address 2 Baud Rate 500 kBaud</p> <p>Click OK to confirm and close the window.</p>	 <p>The screenshot shows a dialog box titled 'CANopen Parameters'. It features a table with columns 'connect' and 'Address (1-127)'. The first row is checked and has 'Controller 1:' and '2' in the respective columns. Other rows for Controller 2 through 8 are unchecked and empty. A 'Baud Rate' dropdown is set to '500 k'. 'Download', 'OK', and 'Cancel' buttons are at the bottom.</p>

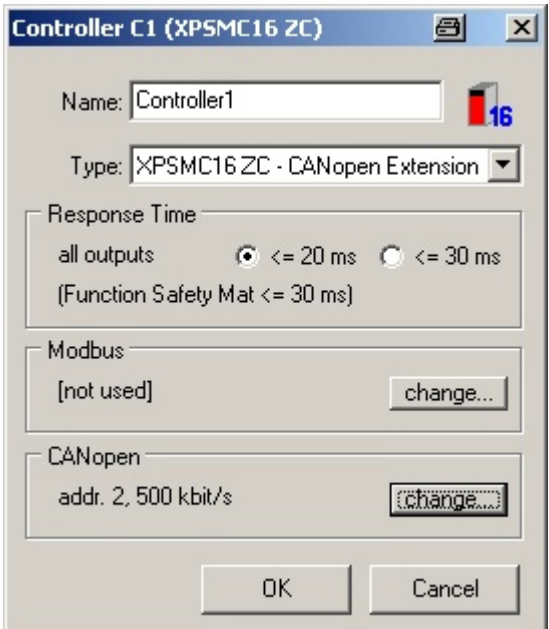
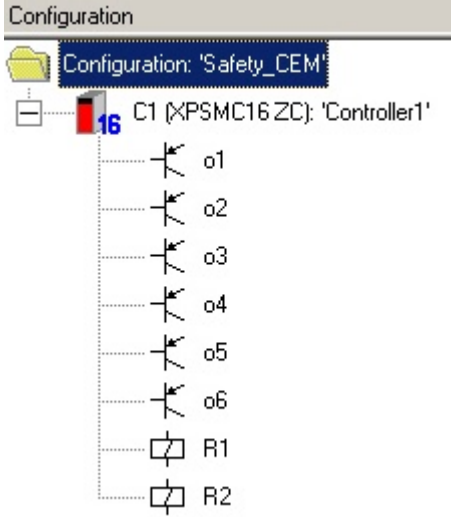
<p>6</p>	<p>The CANopen parameters will now be displayed in the CANopen field.</p> <p>Click OK.</p>	
<p>7</p>	<p>The controller and its outputs are displayed in the Configuration window.</p>	

Defining the Stop Categories

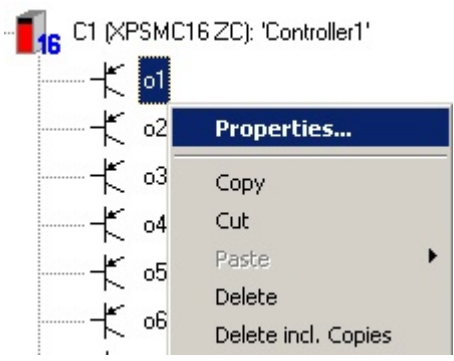
<p>1</p>	<p>A Stop Category can be assigned to the individual outputs.</p> <p>In this application, we will use R1, R2, o1, and o2.</p> <p>Right-click the safety outputs and select Properties... to access the properties screen.</p>	
----------	--	--

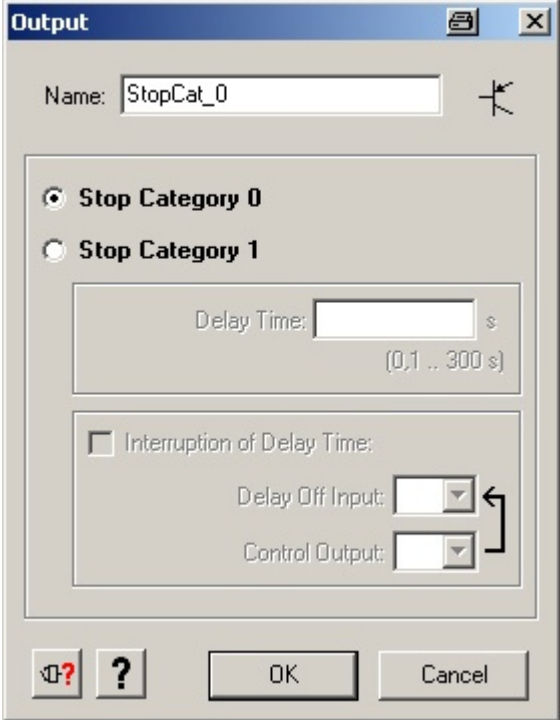
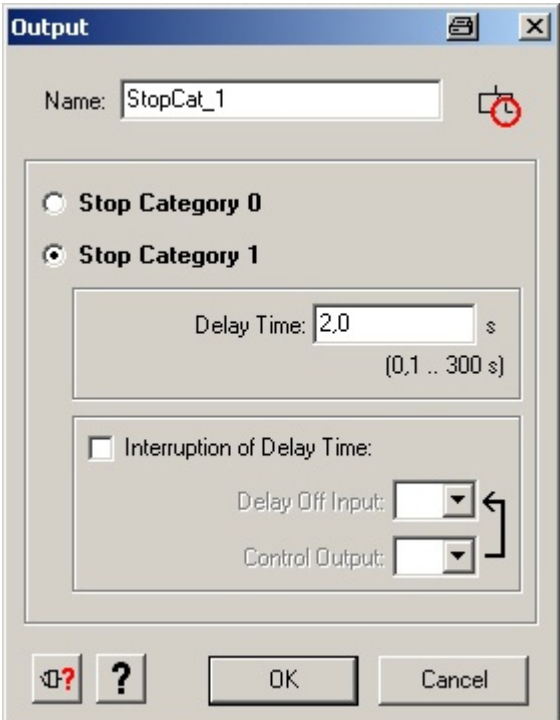
<p>2</p>	<p>Stop Category 0 (stop without delay) is required for R1, o1 and o2.</p> <p>For this purpose, select :</p> <p>Stop Category 0.</p> <p>Now enter a Name.</p> <p>Do not enter anything in the remaining fields.</p> <p>Click OK to confirm.</p>	
<p>3</p>	<p>Stop Category 1 (stop with delay) is required for R2.</p> <p>For this purpose, select</p> <p>Stop Category 1.</p> <p>Now enter a Name and enter 2 seconds in the Delay Time field.</p> <p>Click OK to confirm.</p>	

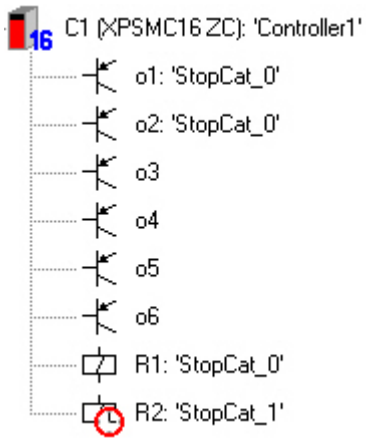
4	The screen should now appear as on the right.	
---	---	--

Adding Safety Elements

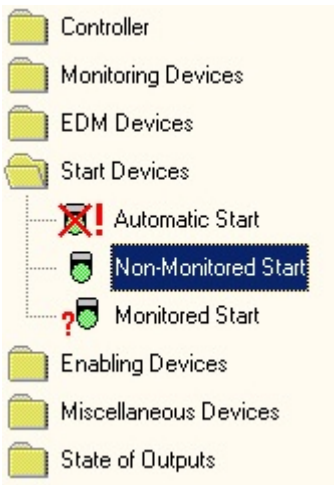

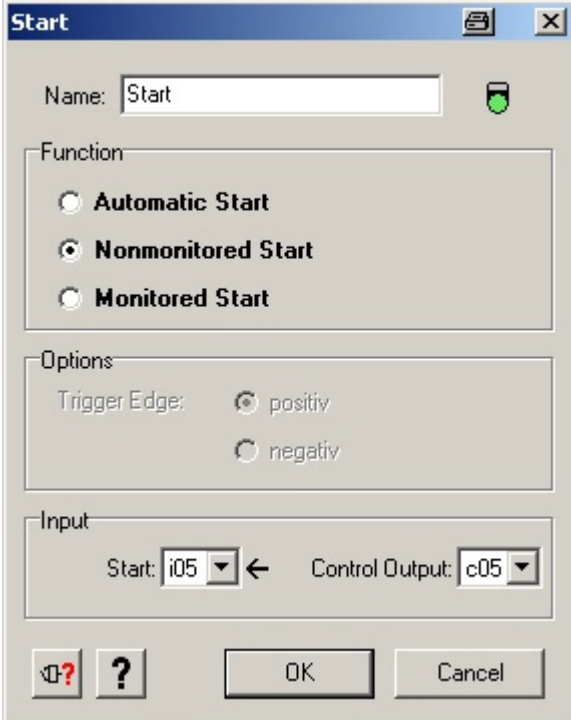
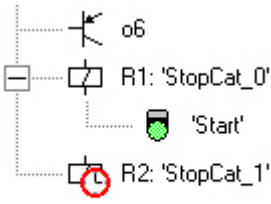
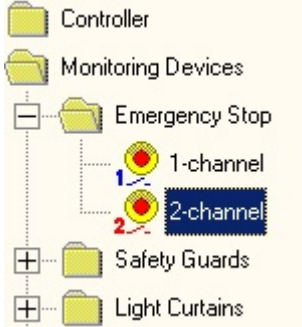
1	The individual safety elements are arranged in various folders in the Device Library window.	
2	<p>The Start Devices folder contains three start block symbols:</p> <p>Automatic Start, Non-Monitored Start Monitored Start.</p> <p>For the purpose of our application, we will be using Non-Monitored Start.</p> <p>For this purpose, drag and drop it to output K1.</p>	

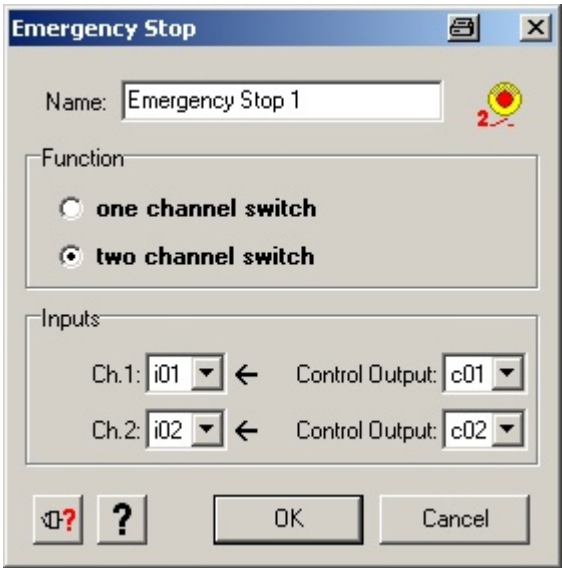
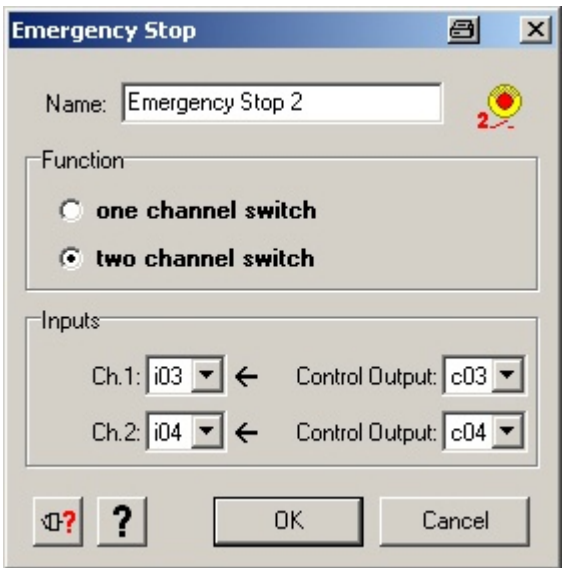
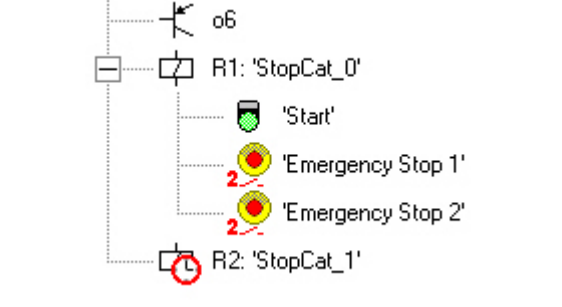
<p>3</p>	<p>The following is entered in the properties window:</p> <p>In the Name field, a particular name (in this case: Start) is assigned.</p> <p>Various types can be selected under Function. In the case of Nonmonitored Start, the safety output is activated as soon as the start button is pressed, provided that all startup requirements have been met.</p> <p>The Options are not available.</p> <p>The safety input (i05) and control output (c05) must be entered under Input.</p>	
<p>4</p>	<p>The start icon is displayed (as shown opposite).</p>	
<p>5</p>	<p>2-channel Emergency Stop buttons are used.</p> <p>For this, select Emergency Stop->2-channel</p> <p>and drag and drop the element to the window on the right.</p>	

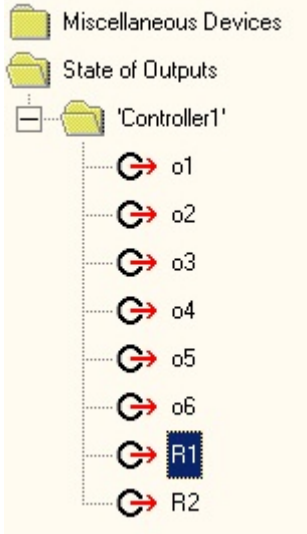
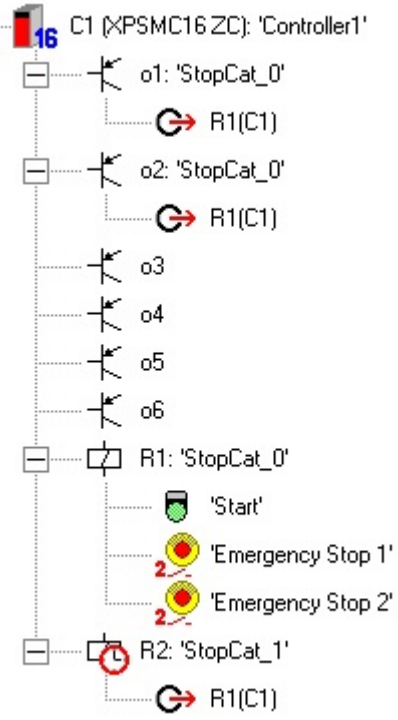
<p>6</p>	<p>For the first Emergency Stop button, the following applies:</p> <p>Select a name (Emergency Stop 1) and function (two channel switch) and set the following under Inputs:</p> <p style="text-align: center;"> Ch.1 i01 Ch.2 i02 Control Output c01 Control Output c02 </p>	
<p>7</p>	<p>For the second emergency stop button, the following applies:</p> <p>Select a name (Emergency Stop 2) and function (two channel switch) and set the following under Inputs:</p> <p style="text-align: center;"> Ch.1 i03 Ch.2 i04 Control Output c03 Control Output c04 </p>	
<p>8</p>	<p>The individual elements are grouped together at output R1, as shown in the screenshot.</p> <p>This means that the function for output R1 has now been set.</p>	

<p>9</p>	<p>In order to make the other outputs (R2, o1 and o2) identical to the function of R1, it is possible to copy the information from the Device Library window by selecting</p> <p>State of Outputs-> Controller1->R1</p> <p>and dragging it onto the outputs in the Configurations window.</p>	
<p>10</p>	<p>The following should now be displayed.</p> <p>The entire parameterization process is now complete.</p>	



Saving and Checking the Project

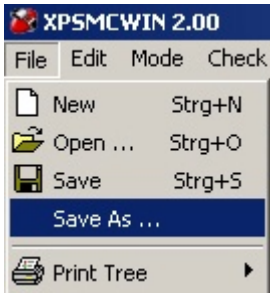
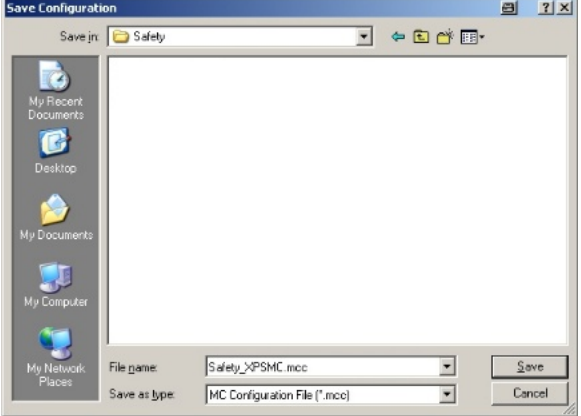

<p>1</p>	<p>The parameterization can be checked by selecting</p> <p>Check->Check Configuration</p>	
<p>2</p>	<p>The result should be that a message window with</p> <p>No errors found</p> <p>is displayed.</p>	

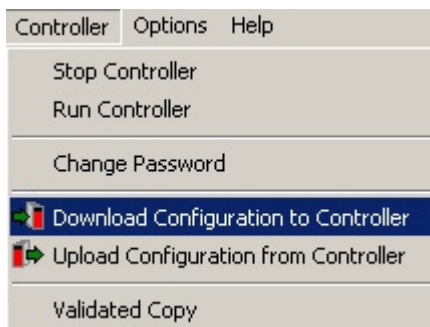
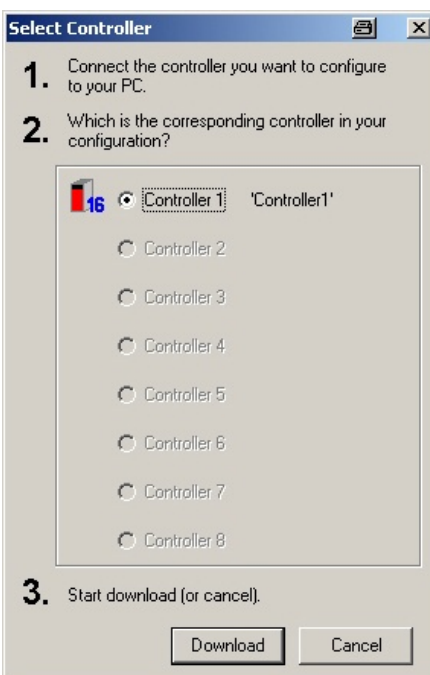
3	<p>The parameterization can be saved by selecting</p> <p>File->Save As...</p>	
4	<p>Here, specify the location for saving the file and the file name (*.mcc).</p> <p>Later on, you will be able to open this file with</p> <p>File->Open</p> <p>in order to edit it.</p>	

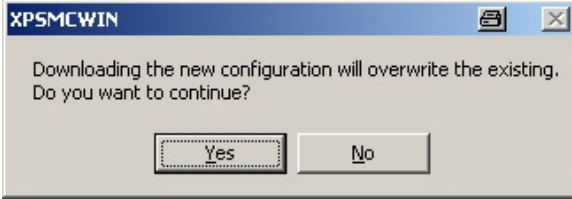
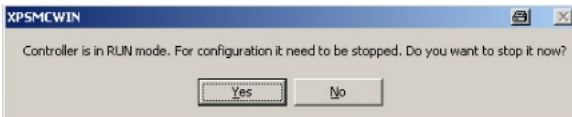
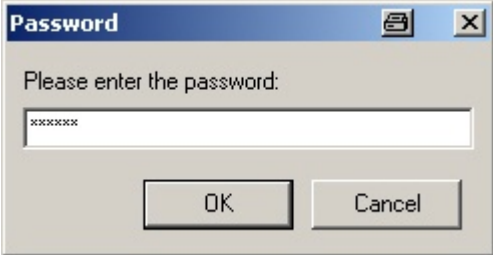

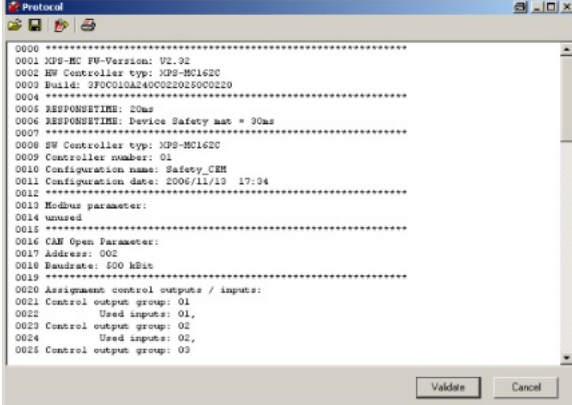
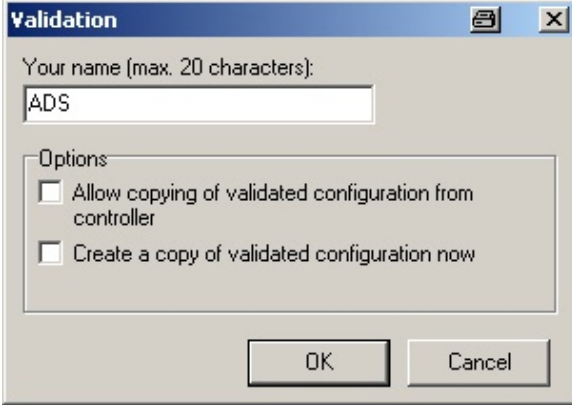
Loading and Starting the Controller

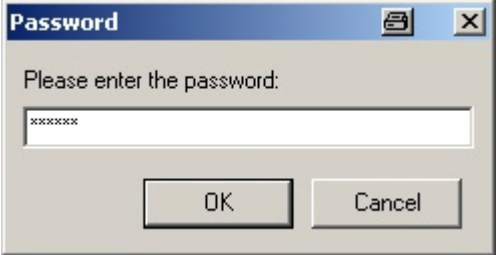
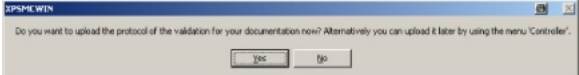
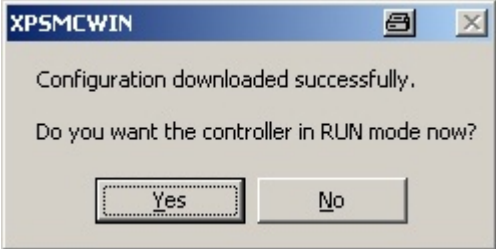
1	<p>You can begin downloading the configuration by selecting</p> <p>Controller->Download Configuration to Controller.</p>	
2	<p>Here, only Controller 1 can be selected.</p>	

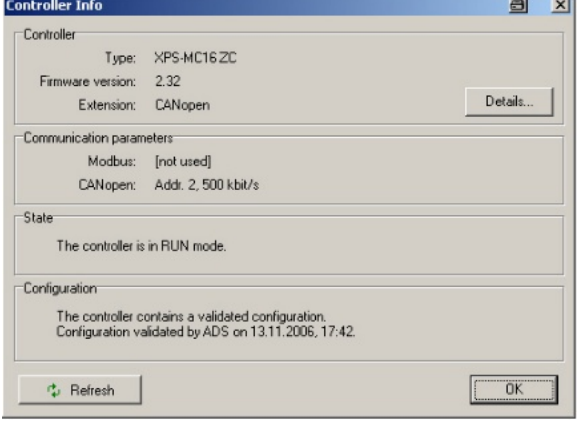
3	Click Yes to confirm.	
4	If the controller is in RUN mode, you must also click Yes to confirm the message that appears.	
5	<p>Enter the password and click OK.</p> <p>Note: The default password is safety.</p> <p>The password can be changed via: Controller->Change Password.</p>	
6	The data is transferred.	
7	<p>The protocol appears.</p> <p>Click Validate to continue.</p>	
8	Enter a unique name (e.g., ADS) under Your name and click OK .	

9	Enter the security password again.	
10	Click Yes to confirm the message that appears (upload and validation).	
11	The configuration has been downloaded successfully. By clicking Yes , the controller can now be set to RUN mode.	
12	The controller operates using the new configuration.	
13	The controller state can be requested by selecting: Controller->Controller Info.	

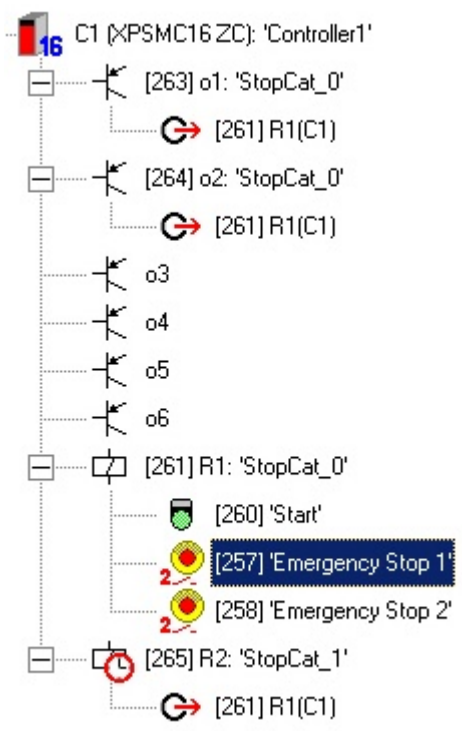
Diagnostics Function

<p>1</p>	<p>It is possible to download various states of an XPSMC to a PC for the purpose of error diagnostics and troubleshooting.</p> <p>Note: During error diagnostics, the XPSMC continues to operate uninterrupted, so that the execution of a complete machine cycle can be monitored.</p> <p>A unique number is assigned to each safety element. This number, plus an error code, is also transferred to the PLC via CANopen.</p> <p>For example, 257 is assigned to the first Emergency Stop button.</p>	
<p>2</p>	<p>You can begin diagnostics by selecting:</p> <p>Mode->Diagnostics.</p>	
<p>3</p>	<p>The current state is displayed in the status bar.</p>	

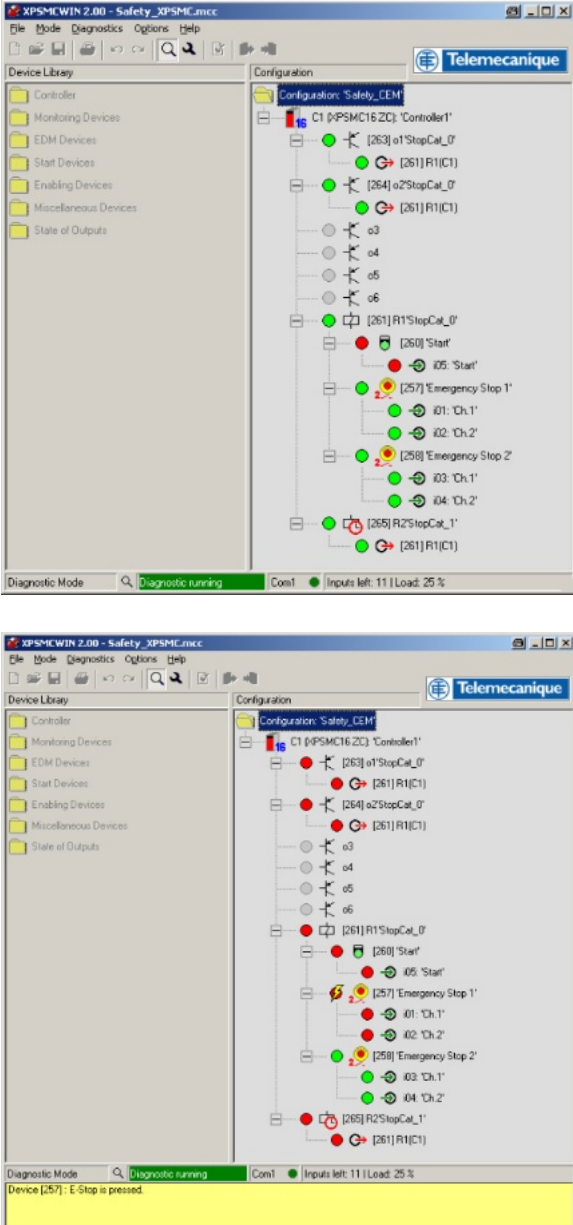
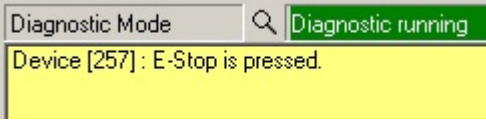
<p>4</p>	<p>Here is an example where the first Emergency Stop button has been pressed. The meanings of the symbols are as follows:</p> <p>Red dot The corresponding safety output is deactivated (safety door is open) or the respective input is open.</p> <p>Red dot with yellow lightning bolt This block has an error. Click on the block to display the relevant error message.</p> <p>Green dot The corresponding safety output is activated or the respective input is closed.</p> <p>Green dot with hourglass This output belongs to Stop Category 1. The conditions for switchover are no longer being met, but the time delay has not yet elapsed.</p> <p>Yellow dot This component/output is activated, but has not yet been started.</p> <p>Gray dot The corresponding safety output is not in use, or the PC has not yet received any error diagnostics data from the XPSMC.</p>	
<p>5</p>	<p>This error message is displayed in the diagnostics field.</p>	

6 This error message can then be reported to the PLC via CANopen, and then transferred to the HMI, where it is displayed (see the screenshot, next to **Safety**).

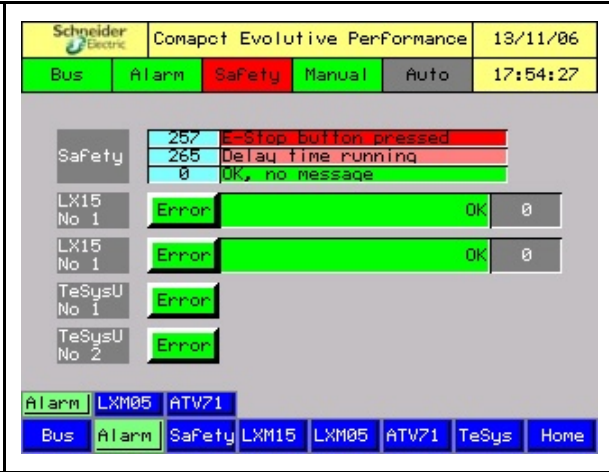

Lexium 15 LP

Introduction This chapter describes how to parameterize the Lexium 15 LP servo drives.

Preconditions Before carrying out the steps described below, you must ensure that:

- The UniLink L parameterization software is installed on your PC.
- The servo drive is connected to the power supply.
- The PC is connected to the servo drive via the serial communication cable.

Proceed as follows to parameterize the servo drive:

- Start up and connect to the drive
- Parameterization, including of the CANopen communication
- Online information
- Save and back up the parameterization data

Starting Up and Connecting to the Drive

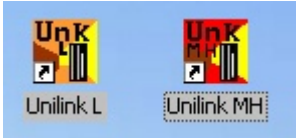
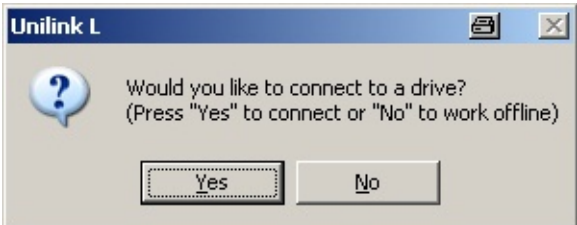
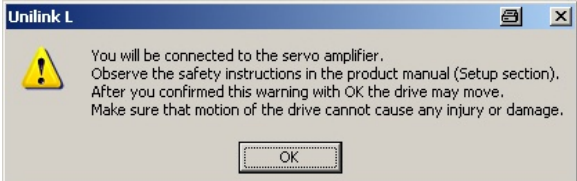
1	<p>Following installation, two UniLink start icons will appear.</p> <p>UniLink L LXM15 LP UniLink MH LXM15 MP/HP</p> <p>For the purpose of this application, we will be using UniLinkL.</p>	
2	<p>Click Yes to confirm the message asking if you would like to connect to the servo drive.</p>	
3	<p>Click OK to confirm the safety warning.</p>	

4 When the software starts up, the user interface is displayed.

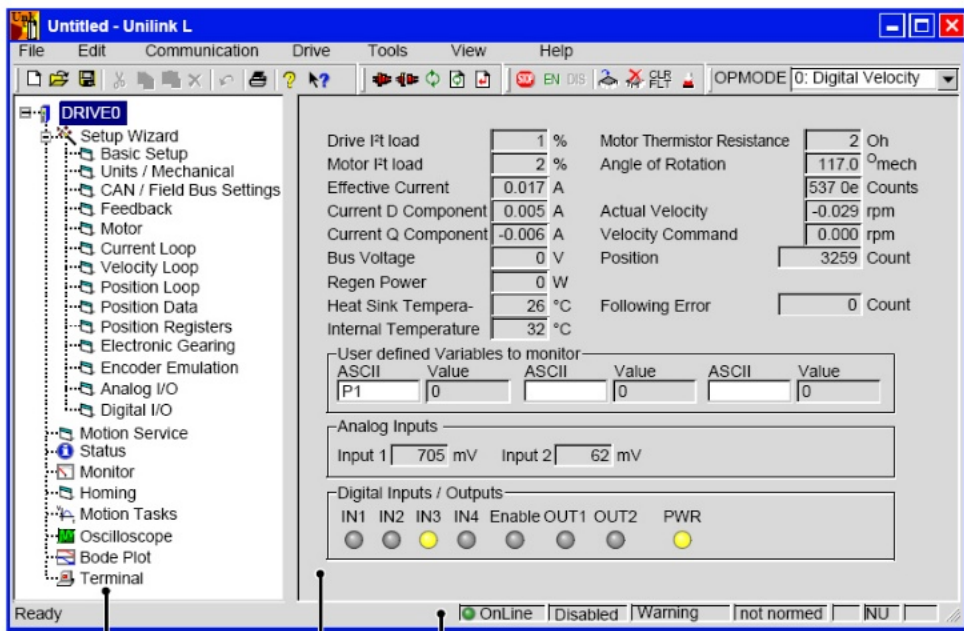

5 The connection parameters can be called via:
Communication->
DeviceParameters...

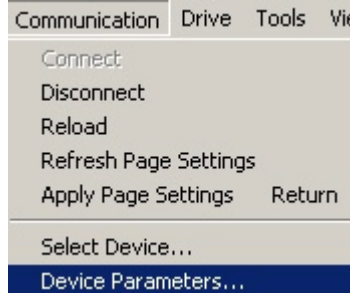

6 Set the **Serial Port**, the **Baud Rate** and the **Timeout** here.
Click **OK** to confirm.
The connection is established by selecting:
Communication-> Connect
from the menu bar.

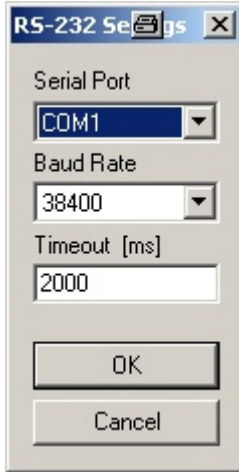

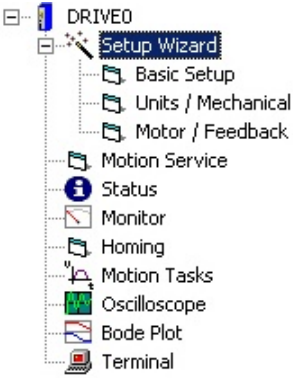
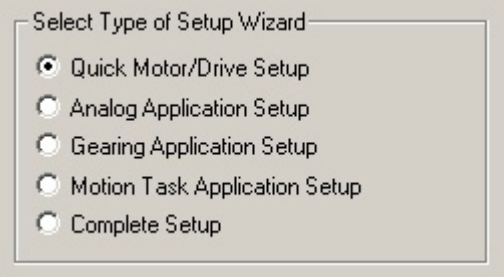
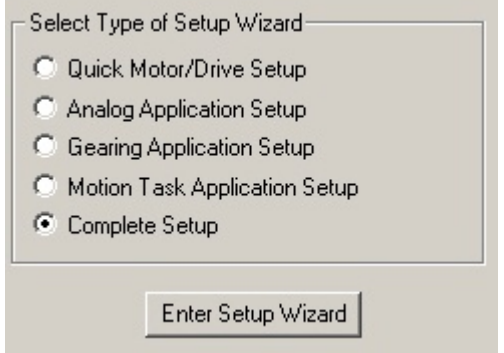
<p>7</p>	<p>Once the connection has been established, the software is used to read the data out of the servo drive. The data can be displayed and modified.</p> <p>By selecting Setup Wizard, it is possible to carry out parameterization in individual stages.</p>	 <p>The screenshot shows a tree view under the 'DRIVE0' header. The 'Setup Wizard' option is highlighted with a blue box. Below it are several sub-items: 'Basic Setup', 'Units / Mechanical', 'Motor / Feedback', 'Motion Service', 'Status', 'Monitor', 'Homing', 'Motion Tasks', 'Oscilloscope', 'Bode Plot', and 'Terminal'.</p>
<p>8</p>	<p>The level of configuration is set to Quick Motor/Drive Setup by default.</p>	 <p>The dialog box is titled 'Select Type of Setup Wizard'. It contains five radio button options: 'Quick Motor/Drive Setup' (which is selected), 'Analog Application Setup', 'Gearing Application Setup', 'Motion Task Application Setup', and 'Complete Setup'.</p>
<p>9</p>	<p>This can be changed to suit your requirements. The most comprehensive setting is Complete Setup.</p> <p>Click Enter Setup Wizard to continue.</p> <p>Note: The individual stages are described in the detailed software documentation (Lexium 15 LP – Servo Drives – Programming manual, around 275 pages). Only an extract of this is provided here.</p>	 <p>The dialog box is the same as in step 8, but now 'Complete Setup' is selected. Below the dialog box, the 'Enter Setup Wizard' button is visible and highlighted with a grey box.</p>

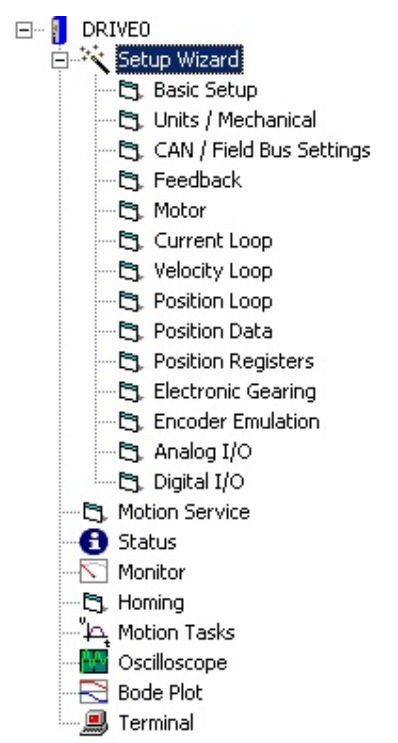
10	<p>The Navigator Frame is adapted in accordance with the setting selected.</p>	 <p>The screenshot shows a tree view under 'DRIVE0'. The 'Setup Wizard' folder is expanded and highlighted. It contains the following sub-items: Basic Setup, Units / Mechanical, CAN / Field Bus Settings, Feedback, Motor, Current Loop, Velocity Loop, Position Loop, Position Data, Position Registers, Electronic Gearing, Encoder Emulation, Analog I/O, and Digital I/O. Below this are other folders: Motion Service, Status, Monitor, Homing, Motion Tasks, Oscilloscope, Bode Plot, and Terminal.</p>
----	--	---

**Parameters
CANopen
Communication**

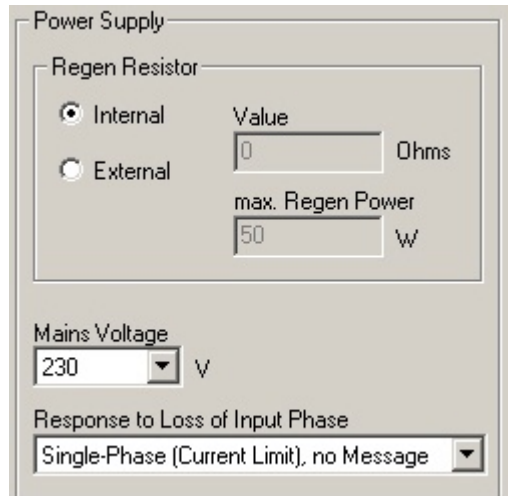
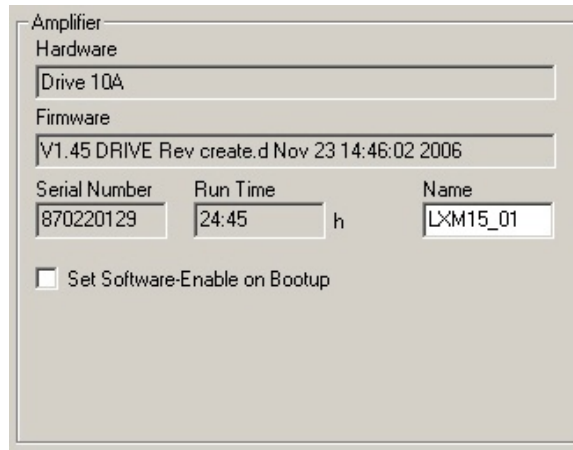
1	<p>First, switch to Basic Setup.</p> <p>The Power Supply area has the following settings:</p> <p>Regen Resistor: Internal</p> <p>Mains voltage: 230 V</p> <p>and Single-Phase ...</p>	 <p>The screenshot shows the 'Power Supply' configuration window. Under 'Regen Resistor', the 'Internal' radio button is selected. The 'Value' field is set to 0 Ohms, and the 'max. Regen Power' field is set to 50 W. The 'Mains Voltage' dropdown is set to 230 V. The 'Response to Loss of Input Phase' dropdown is set to 'Single-Phase (Current Limit), no Message'.</p>
2	<p>The information from the servo drive is displayed on the right-hand side (Amplifier).</p> <p>This includes Hardware, Firmware, Serial Number and Run Time.</p> <p>You can change the default Name here.</p>	 <p>The screenshot shows the 'Amplifier' information window. It displays the following data:</p> <ul style="list-style-type: none"> Hardware: Drive 10A Firmware: V1.45 DRIVE Rev create.d Nov 23 14:46:02 2006 Serial Number: 870220129 Run Time: 24:45 h Name: LXM15_01 <p>There is also a checkbox for 'Set Software-Enable on Bootup' which is currently unchecked.</p>

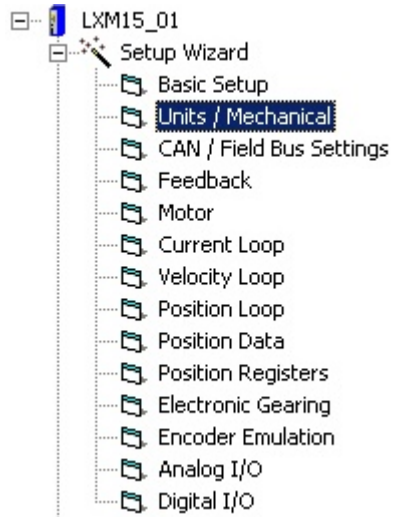
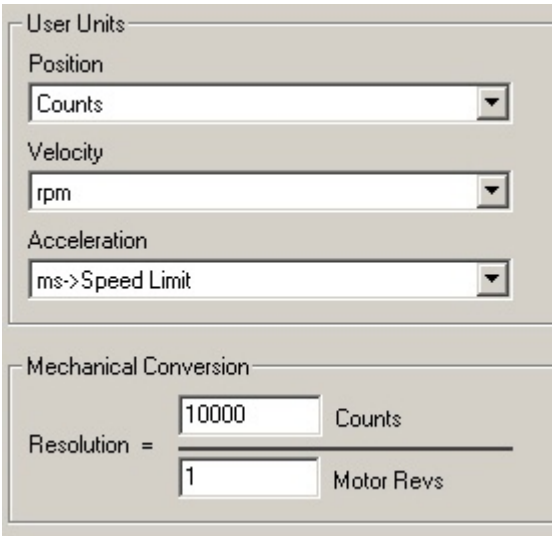
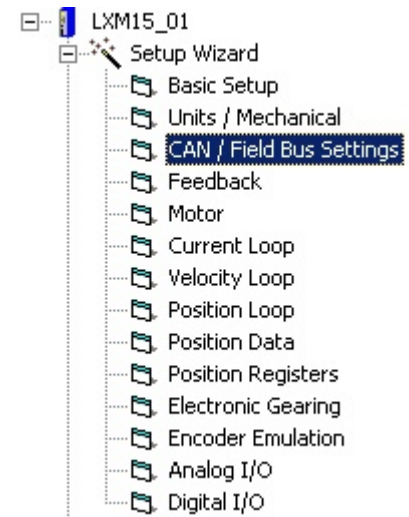
<p>3</p>	<p>The name is displayed at the top of the Navigator Frame. Select Units/Mechanical to continue.</p>	
<p>4</p>	<p>Here, the following exchange settings have been made for the application:</p> <p>Position = Counts Velocity = rpm Acceleration = ms->Speed Limit</p> <p>10,000 counts are equivalent to 1 motor revolution.</p>	
<p>5</p>	<p>The parameters for communication with the PLC are set under CAN/Field Bus Settings.</p>	

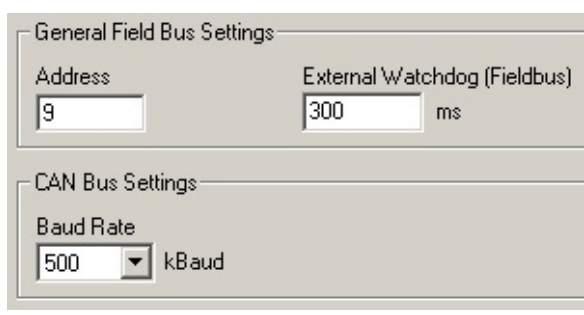
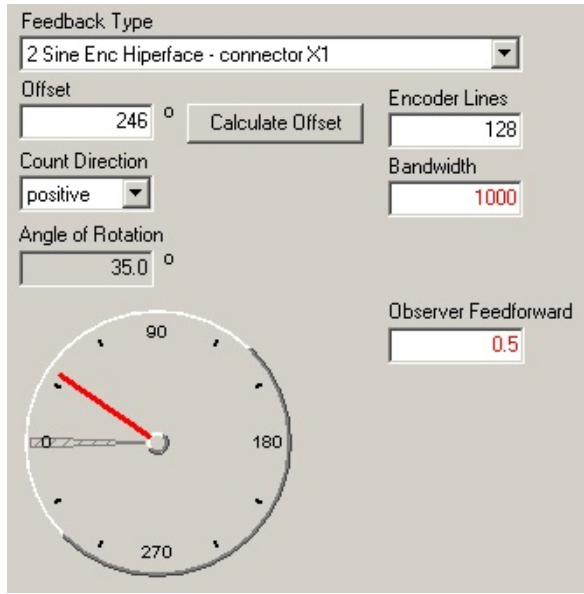
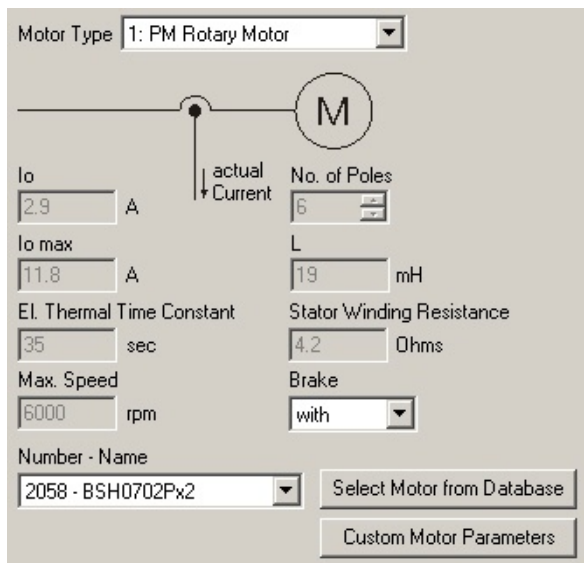
<p>6</p>	<p>Enter 9 for the CANopen address of the 1st LXM15 and 10 for that of the 2nd.</p> <p>Set 300 ms for the Watchdog and 500 kBaud for the Baud Rate.</p>	
<p>7</p>	<p>The next step is to select the Feedback Type.</p> <p>In this case, the servo drive has an encoder with a Hiperface interface.</p>	
<p>8</p>	<p>The motor being used can be selected from the drop-down list under Number – Name.</p> <p>If it is not available, it is possible to enter the parameters in a table via Custom Motor Parameters. Following this, under Brake you must indicate whether the servo has a brake.</p>	

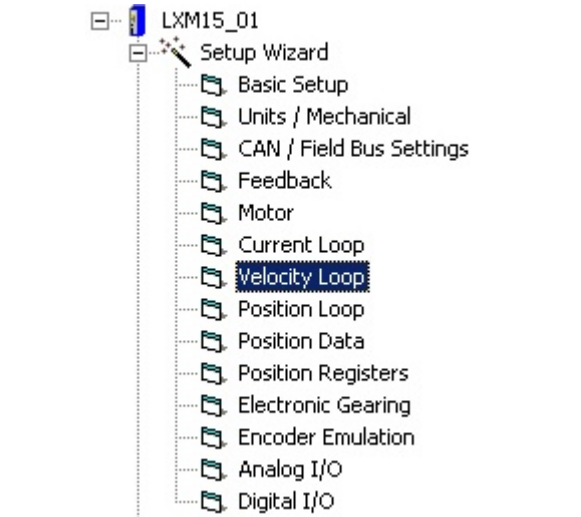
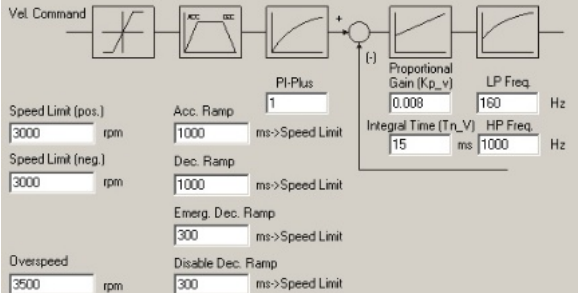
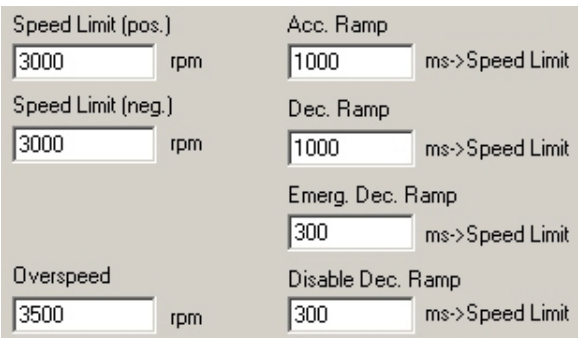
<p>9</p>	<p>Select Velocity Loop to continue.</p>	 <p>LXM15_01 Setup Wizard Basic Setup Units / Mechanical CAN / Field Bus Settings Feedback Motor Current Loop Velocity Loop Position Loop Position Data Position Registers Electronic Gearing Encoder Emulation Analog I/O Digital I/O</p>
<p>10</p>	<p>Enter the limits for various speeds and ramps here.</p>	 <p>Vel. Command</p> <p>Speed Limit (pos.) 3000 rpm Speed Limit (neg.) 3000 rpm Overspeed 3500 rpm</p> <p>Acc. Ramp 1000 ms->Speed Limit Dec. Ramp 1000 ms->Speed Limit Emerg. Dec. Ramp 300 ms->Speed Limit Disable Dec. Ramp 300 ms->Speed Limit</p> <p>PI-Plus 1 Proportional Gain (Kp_v) 0.008 Integral Time (Tn_V) 15 ms LP Freq. 160 Hz HP Freq. 1000 Hz</p>
<p>11</p>	<p>A detail from the screenshot above is shown opposite.</p>	 <p>Speed Limit (pos.) 3000 rpm Speed Limit (neg.) 3000 rpm Overspeed 3500 rpm</p> <p>Acc. Ramp 1000 ms->Speed Limit Dec. Ramp 1000 ms->Speed Limit Emerg. Dec. Ramp 300 ms->Speed Limit Disable Dec. Ramp 300 ms->Speed Limit</p>



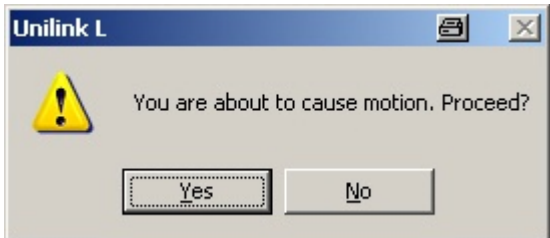
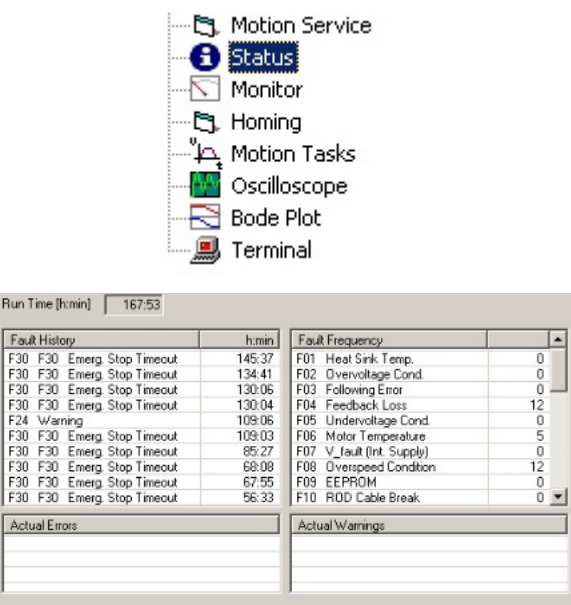
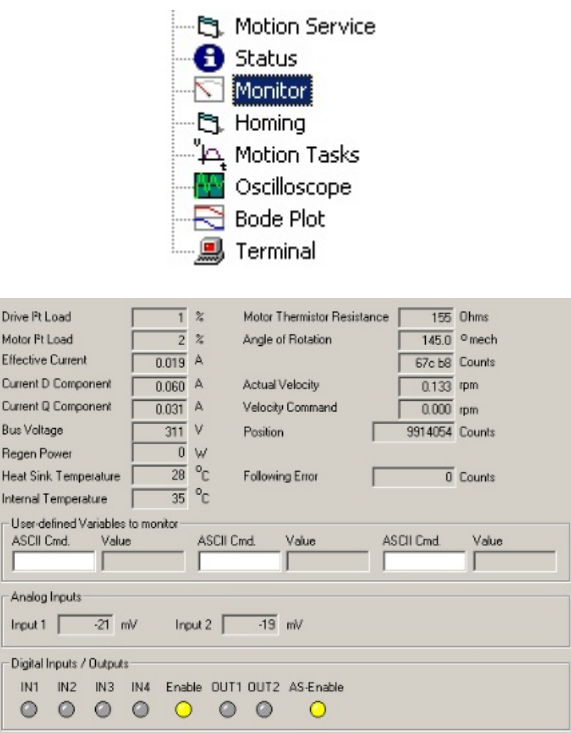

<p>12</p>	<p>Under Position Data, the parameters required for positioning are set. These include maximum velocities (v max) for positioning purposes, ramps (acc/dcc) and accuracy (Counts).</p> <p>All parameters are determined by the conditions on site.</p>	
-----------	---	--

Online Information

<p>1</p>	<p>UniLink can also be used to control the servo drive and enter and optimise values.</p>	
<p>2</p>	<p>You can enter a velocity in the rpm field (accessed via Motion Service) and specify the direction of rotation using + / -.</p>	

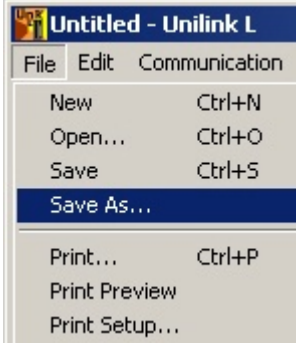
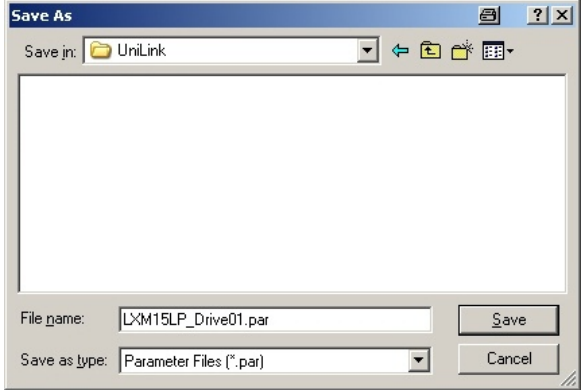
3	Click Yes to confirm the safety message.																																																							
4	Status is used to display the error and warning memory.	 <table border="1" data-bbox="874 757 1157 943"> <thead> <tr> <th>Fault History</th> <th>h:min</th> <th>Fault Frequency</th> <th></th> </tr> </thead> <tbody> <tr><td>F30 F30 Emerg Stop Timeout</td><td>145:37</td><td>F01 Heat Sink Temp.</td><td>0</td></tr> <tr><td>F30 F30 Emerg Stop Timeout</td><td>134:41</td><td>F02 Overvoltage Cond.</td><td>0</td></tr> <tr><td>F30 F30 Emerg Stop Timeout</td><td>130:06</td><td>F03 Following Error</td><td>0</td></tr> <tr><td>F30 F30 Emerg Stop Timeout</td><td>130:04</td><td>F04 Feedback Loss</td><td>12</td></tr> <tr><td>F24 Warning</td><td>109:06</td><td>F05 Undervoltage Cond.</td><td>0</td></tr> <tr><td>F30 F30 Emerg Stop Timeout</td><td>109:03</td><td>F06 Motor Temperature</td><td>5</td></tr> <tr><td>F30 F30 Emerg Stop Timeout</td><td>85:27</td><td>F07 V_fault (Int. Supply)</td><td>0</td></tr> <tr><td>F30 F30 Emerg Stop Timeout</td><td>68:08</td><td>F08 Overspeed Condition</td><td>12</td></tr> <tr><td>F30 F30 Emerg Stop Timeout</td><td>67:55</td><td>F09 EEPROM</td><td>0</td></tr> <tr><td>F30 F30 Emerg Stop Timeout</td><td>56:33</td><td>F10 ROD Cable Break</td><td>0</td></tr> </tbody> </table>	Fault History	h:min	Fault Frequency		F30 F30 Emerg Stop Timeout	145:37	F01 Heat Sink Temp.	0	F30 F30 Emerg Stop Timeout	134:41	F02 Overvoltage Cond.	0	F30 F30 Emerg Stop Timeout	130:06	F03 Following Error	0	F30 F30 Emerg Stop Timeout	130:04	F04 Feedback Loss	12	F24 Warning	109:06	F05 Undervoltage Cond.	0	F30 F30 Emerg Stop Timeout	109:03	F06 Motor Temperature	5	F30 F30 Emerg Stop Timeout	85:27	F07 V_fault (Int. Supply)	0	F30 F30 Emerg Stop Timeout	68:08	F08 Overspeed Condition	12	F30 F30 Emerg Stop Timeout	67:55	F09 EEPROM	0	F30 F30 Emerg Stop Timeout	56:33	F10 ROD Cable Break	0										
Fault History	h:min	Fault Frequency																																																						
F30 F30 Emerg Stop Timeout	145:37	F01 Heat Sink Temp.	0																																																					
F30 F30 Emerg Stop Timeout	134:41	F02 Overvoltage Cond.	0																																																					
F30 F30 Emerg Stop Timeout	130:06	F03 Following Error	0																																																					
F30 F30 Emerg Stop Timeout	130:04	F04 Feedback Loss	12																																																					
F24 Warning	109:06	F05 Undervoltage Cond.	0																																																					
F30 F30 Emerg Stop Timeout	109:03	F06 Motor Temperature	5																																																					
F30 F30 Emerg Stop Timeout	85:27	F07 V_fault (Int. Supply)	0																																																					
F30 F30 Emerg Stop Timeout	68:08	F08 Overspeed Condition	12																																																					
F30 F30 Emerg Stop Timeout	67:55	F09 EEPROM	0																																																					
F30 F30 Emerg Stop Timeout	56:33	F10 ROD Cable Break	0																																																					
5	<p>Monitor displays other information such as current, temperature, status of inputs and outputs, etc.</p> <p>Please consult the documentation for other possibilities.</p>	 <table border="1" data-bbox="874 1368 1374 1576"> <tbody> <tr><td>Drive R Load</td><td>1</td><td>%</td><td>Motor Thermistor Resistance</td><td>155</td><td>Ohms</td></tr> <tr><td>Motor R Load</td><td>2</td><td>%</td><td>Angle of Rotation</td><td>145.0</td><td>° mech</td></tr> <tr><td>Effective Current</td><td>0.019</td><td>A</td><td>67c b8</td><td></td><td>Counts</td></tr> <tr><td>Current D Component</td><td>0.060</td><td>A</td><td>Actual Velocity</td><td>0.133</td><td>rpm</td></tr> <tr><td>Current Q Component</td><td>0.031</td><td>A</td><td>Velocity Command</td><td>0.000</td><td>rpm</td></tr> <tr><td>Bus Voltage</td><td>311</td><td>V</td><td>Position</td><td>9914054</td><td>Counts</td></tr> <tr><td>Regen Power</td><td>0</td><td>W</td><td>Following Error</td><td>0</td><td>Counts</td></tr> <tr><td>Heat Sink Temperature</td><td>28</td><td>°C</td><td></td><td></td><td></td></tr> <tr><td>Internal Temperature</td><td>35</td><td>°C</td><td></td><td></td><td></td></tr> </tbody> </table>	Drive R Load	1	%	Motor Thermistor Resistance	155	Ohms	Motor R Load	2	%	Angle of Rotation	145.0	° mech	Effective Current	0.019	A	67c b8		Counts	Current D Component	0.060	A	Actual Velocity	0.133	rpm	Current Q Component	0.031	A	Velocity Command	0.000	rpm	Bus Voltage	311	V	Position	9914054	Counts	Regen Power	0	W	Following Error	0	Counts	Heat Sink Temperature	28	°C				Internal Temperature	35	°C			
Drive R Load	1	%	Motor Thermistor Resistance	155	Ohms																																																			
Motor R Load	2	%	Angle of Rotation	145.0	° mech																																																			
Effective Current	0.019	A	67c b8		Counts																																																			
Current D Component	0.060	A	Actual Velocity	0.133	rpm																																																			
Current Q Component	0.031	A	Velocity Command	0.000	rpm																																																			
Bus Voltage	311	V	Position	9914054	Counts																																																			
Regen Power	0	W	Following Error	0	Counts																																																			
Heat Sink Temperature	28	°C																																																						
Internal Temperature	35	°C																																																						

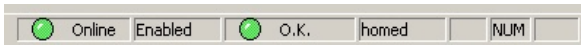
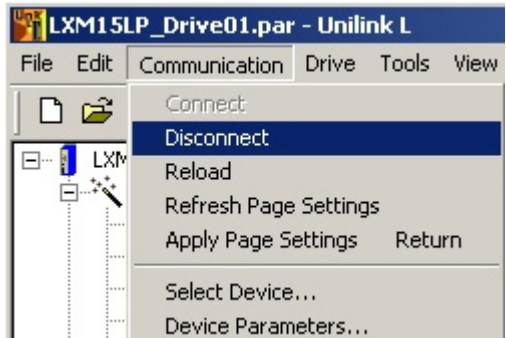
Saving and Backing Up the Parameterization Data.

<p>1</p>	<p>The data can be saved for later use (exchanging devices, etc.) by selecting:</p> <p>File->Save As.</p> <p>The data saved is read into UniLink again via:</p> <p>File->Open.</p>	
<p>2</p>	<p>Here, specify the location for saving the file and the file name (*.par).</p>	
<p>3</p>	<p>The parameter data is then saved in the servo drive so that the settings will not be lost in the event of a power failure.</p> <p>To do this, select:</p> <p>Drive->Save to EEPROM</p>	
<p>4</p>	<p>The status is displayed by the status bar.</p>	
<p>5</p>	<p>To disconnect the servo drive, select:</p> <p>Communication->Disconnect.</p>	
<p>6</p>	<p>The status bar indicates whether the disconnection has been successful.</p>	

PowerSuite

Introduction

PowerSuite is a tool that assists in the configuration and monitoring of the control devices for electrical motors.

With the help of PowerSuite, the user can define a machinery setup and outline configurations and the associated communication parameters.

The advantages of using PowerSuite are that you

- Can save the data on your PC and copy it as you wish
- Can print out the documentation *and*
- Can be assisted in optimizing the parameters online.

The version described here can be used for Lexium 05 and Altivar 71 (this configuration).

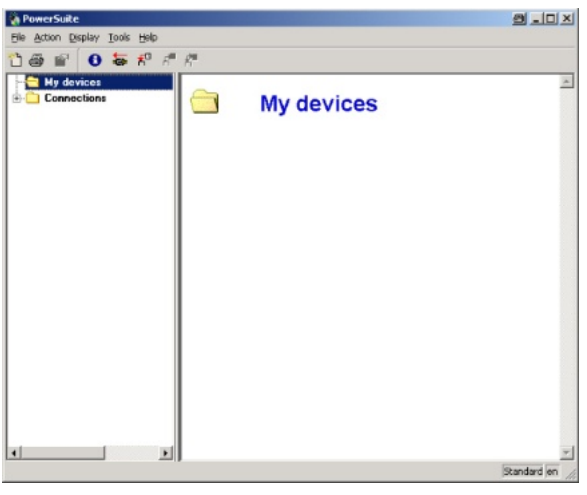
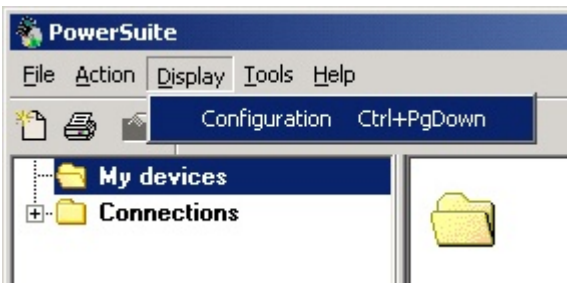

General Settings

Here, superordinate settings are made.

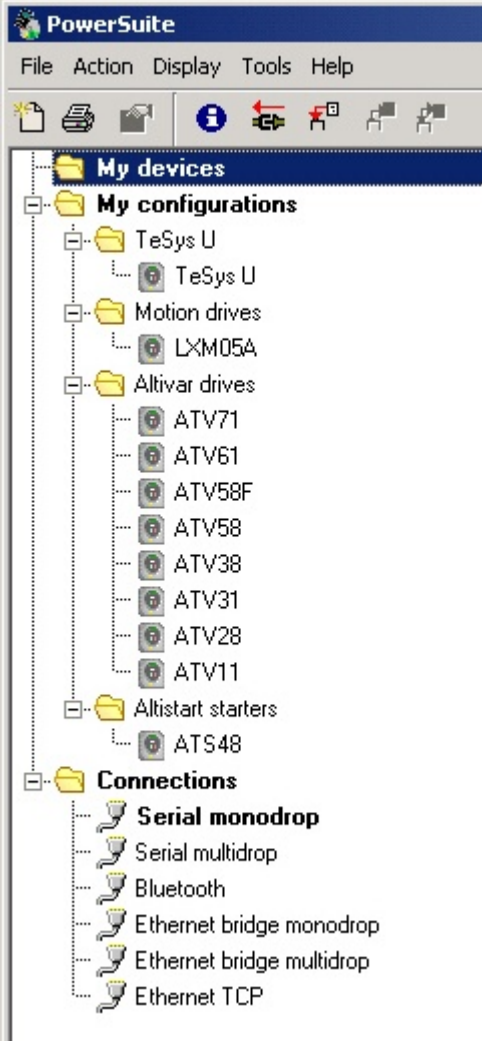
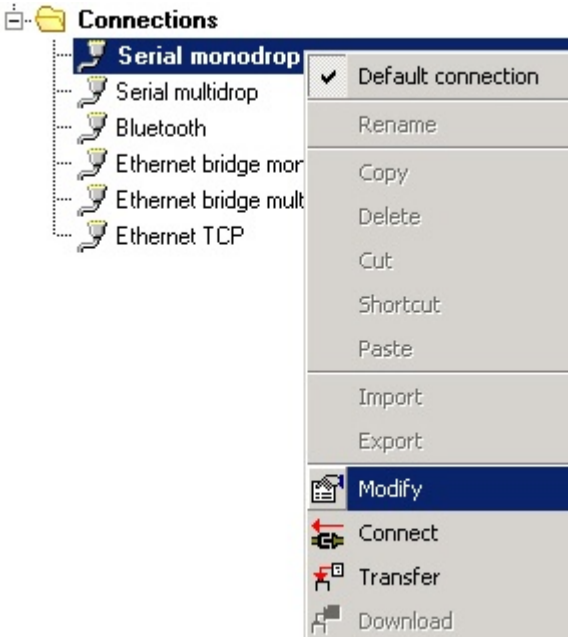
1	When PowerSuite is called up, the window opposite appears.	
2	Select Configuration in the Display menu to view it in the browser.	

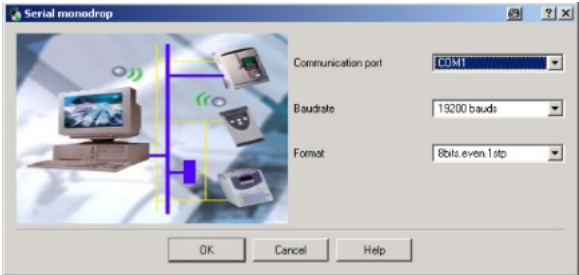
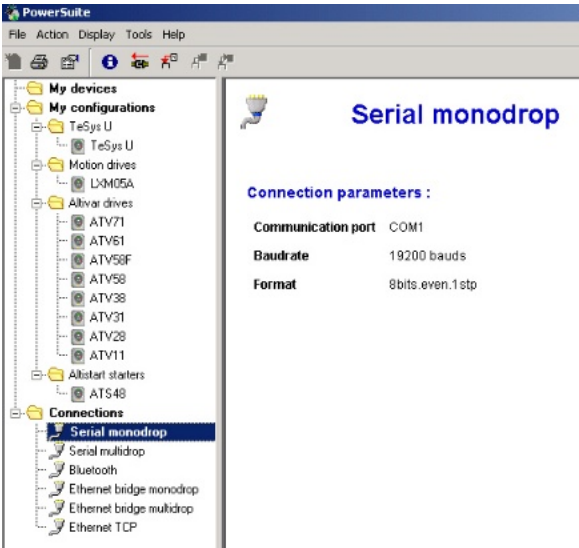
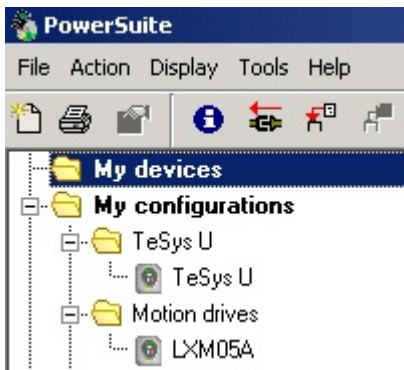
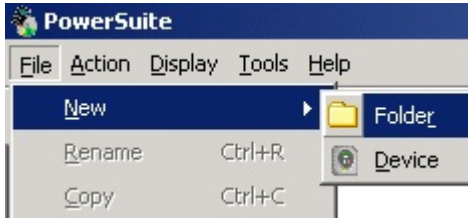
<p>3</p>	<p>The browser on the left-hand side is responsible for managing the machinery.</p>	 <p>The screenshot shows the PowerSuite application window. The title bar reads 'PowerSuite' and the menu bar includes 'File', 'Action', 'Display', 'Tools', and 'Help'. Below the menu bar is a toolbar with icons for file operations and device management. The main area is a tree view under the heading 'My devices'. It contains several folders: 'My configurations', 'Connections', 'TeSys U', 'Motion drives', 'Altivar drives', and 'Alistart starters'. Each folder contains specific device or configuration icons. For example, 'Altivar drives' includes models like ATV71, ATV61, ATV58F, ATV58, ATV38, ATV31, ATV28, and ATV11. The 'Connections' folder lists various communication protocols like Serial monodrop, Serial multidrop, Bluetooth, Ethernet bridge monodrop, Ethernet bridge multidrop, and Ethernet TCP.</p>
<p>4</p>	<p>Under Connections, the settings can be checked and modified (Modify).</p>	 <p>This screenshot is a zoomed-in view of the 'Connections' folder from the previous image. The 'Serial monodrop' item is selected, and a context menu is open over it. The menu items are: 'Default connection' (checked), 'Rename', 'Copy', 'Delete', 'Cut', 'Shortcut', 'Paste', 'Import', 'Export', 'Modify' (highlighted in blue), 'Connect', 'Transfer', and 'Download'. The 'Serial monodrop' item is represented by a computer monitor icon.</p>

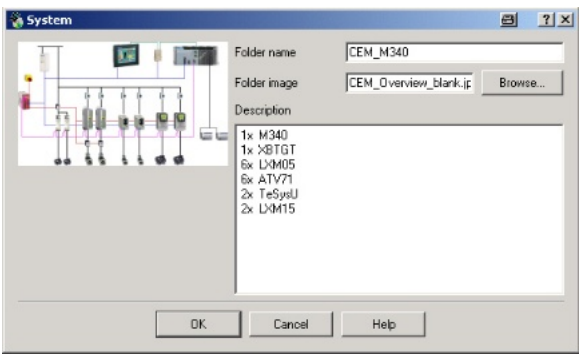
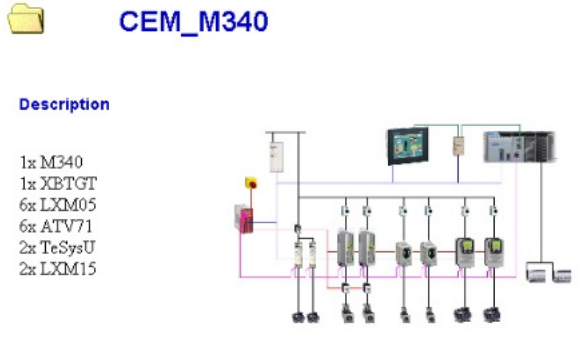
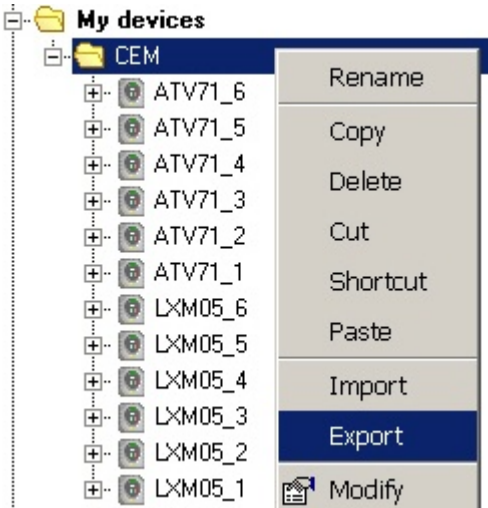
5	<p>Under Serial monodrop, you need to select the COM communication port that is being used.</p>	
6	<p>Selecting the connection displays the settings (as shown opposite).</p>	
7	<p>In PowerSuite, it is possible to group the various drives into subfolders (e.g., according to the machine).</p> <p>To do this, select the My devices main folder.</p>	
8	<p>Then select File->New->Folder.</p>	

<p>9</p>	<p>Specify a Folder name in the window that appears.</p> <p>It is also possible to provide both a link to an image and a Description of it.</p>	
<p>10</p>	<p>When a folder is selected, the data entered appears in the window on the right-hand side.</p>	
<p>11</p>	<p>It is possible to group and export all drives, including their data, in a *.PSF file.</p>	
<p>12</p>	<p>If PowerSuite is connected to the drive, the operator menu at the bottom of the parameter window can be used to control the drive.</p>	

Lexium 05

Introduction This chapter describes how to parameterize Lexium 05 servo drives.

Preconditions Before carrying out the steps described below, you must ensure that:

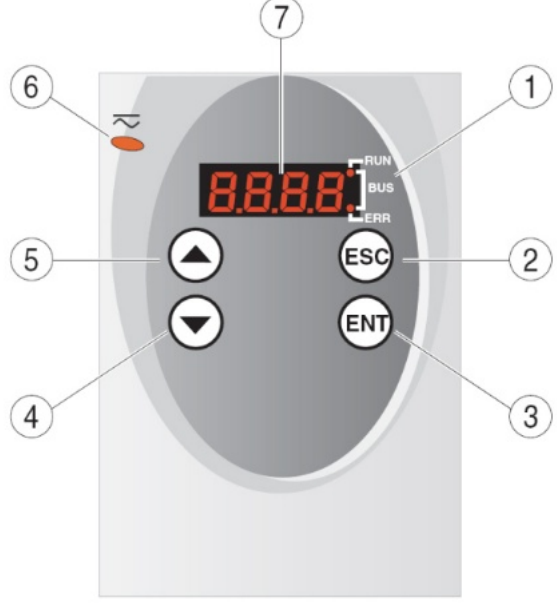

- The PowerSuite parameterization software is installed on your PC.
- The servo drive is connected to the power supply.
- The PC is connected to the servo drive via the communication cable.

LXM05 Manual Setup



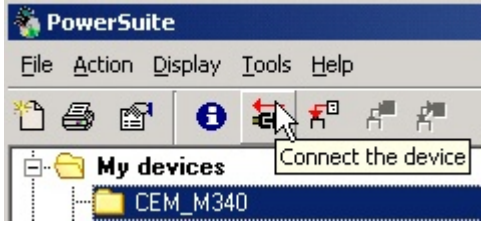
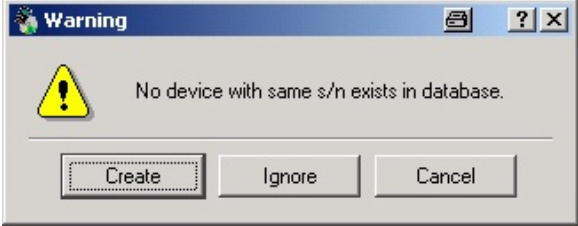

1	<p>After wiring is complete, the drive control parameters must be set.</p> <p>Parameters can be edited via the integral operating panel (HMI).</p>	 <p>(1) LEDs for fieldbus ESC: - exit a menu or parameter - return from the displayed to the last saved value (2) ENT: - call a menu or parameter - save the displayed value to EEPROM (3) Down arrow: - switch to next menu or parameter - reduce the displayed value (4) Up arrow: - switch to previous menu or parameter - increase the displayed value (5) Red LED on: DC bus under power (6) Status display</p>
---	--	---

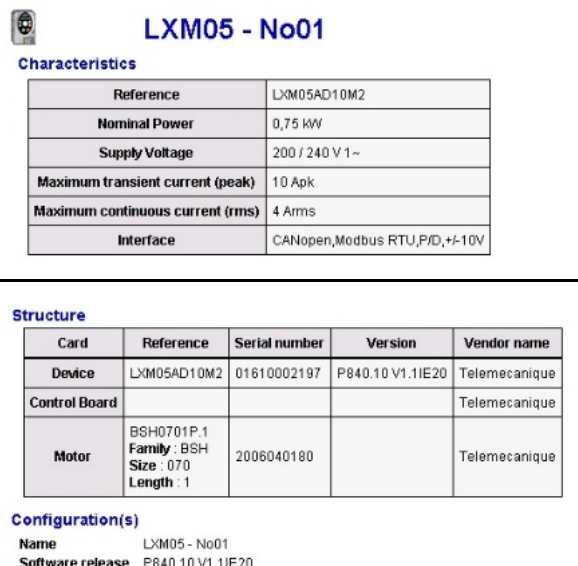
<p>2</p>	<p>The HMI operates on the basis of menus. The screenshot to the right shows the top level of the menu structure.</p> <p>In order to gain access via the PowerSuite software, you will first need to check the Modbus parameters.</p> <p>Under</p> <p>CoM, set MbAd = 1 and Mbbd = 19.2</p>	
<p>3</p>	<p>When the drive is supplied with 24V for the first time, or if the factory settings have previously been loaded with the <code>PARfactorySet</code> parameter, all the drive functions are still blocked.</p> <p>You must carry out an initial setup procedure.</p> <p>To establish the link to the CANopen master, you will need to make settings in respect of the following:</p> <ul style="list-style-type: none"> - Method of control - Signal selection position interface - CANopen parameter and Logic type <p>On completion, the drive reports "RDY" (ready) in the status display.</p>	

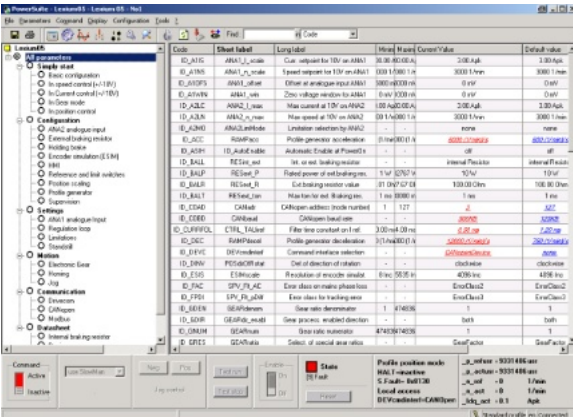
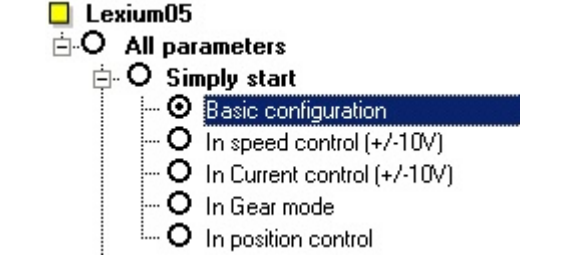
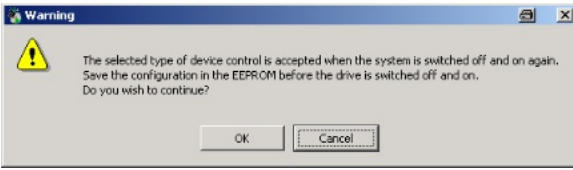

**PowerSuite
with LXM05**

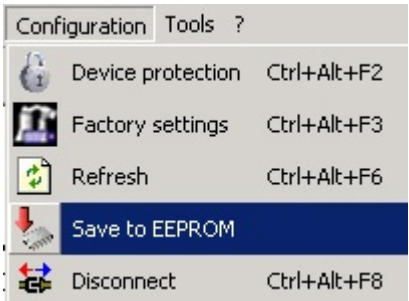
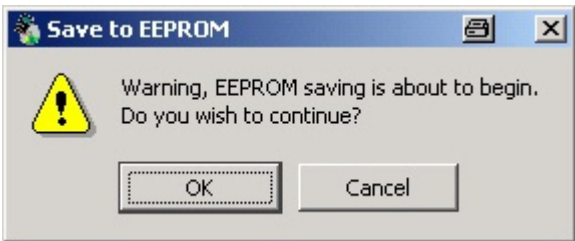
1	As well as making settings manually, it is also possible to use the PowerSuite configuration software.																																	
2	Following startup, a connection to the device is established via Action->Connect or by clicking on the corresponding icon.																																	
3	You will receive a warning that there is no record of the new device. Select Create .																																	
4	Next, you need to enter the name of the configuration or device.																																	
5	The data is read out from the Lexium 05.																																	
6	Once the transfer is complete, the device data will be displayed.	 <p>LXM05 - No01</p> <p>Characteristics</p> <table border="1"> <tr> <td>Reference</td> <td>LXM05AD10M2</td> </tr> <tr> <td>Nominal Power</td> <td>0,75 kW</td> </tr> <tr> <td>Supply Voltage</td> <td>200 / 240 V 1~</td> </tr> <tr> <td>Maximum transient current (peak)</td> <td>10 Apk</td> </tr> <tr> <td>Maximum continuous current (rms)</td> <td>4 Arms</td> </tr> <tr> <td>Interface</td> <td>CANopen, Modbus RTU, P/D, +/-10V</td> </tr> </table> <p>Structure</p> <table border="1"> <thead> <tr> <th>Card</th> <th>Reference</th> <th>Serial number</th> <th>Version</th> <th>Vendor name</th> </tr> </thead> <tbody> <tr> <td>Device</td> <td>LXM05AD10M2</td> <td>01610002197</td> <td>P840.10 V1.1IE20</td> <td>Telemecanique</td> </tr> <tr> <td>Control Board</td> <td></td> <td></td> <td></td> <td>Telemecanique</td> </tr> <tr> <td>Motor</td> <td>BSH0701P.1 Family : BSH Size : 070 Length : 1</td> <td>2006040180</td> <td></td> <td>Telemecanique</td> </tr> </tbody> </table> <p>Configuration(s)</p> <p>Name LXM05 - No01 Software release P840.10 V1.1IE20</p>	Reference	LXM05AD10M2	Nominal Power	0,75 kW	Supply Voltage	200 / 240 V 1~	Maximum transient current (peak)	10 Apk	Maximum continuous current (rms)	4 Arms	Interface	CANopen, Modbus RTU, P/D, +/-10V	Card	Reference	Serial number	Version	Vendor name	Device	LXM05AD10M2	01610002197	P840.10 V1.1IE20	Telemecanique	Control Board				Telemecanique	Motor	BSH0701P.1 Family : BSH Size : 070 Length : 1	2006040180		Telemecanique
Reference	LXM05AD10M2																																	
Nominal Power	0,75 kW																																	
Supply Voltage	200 / 240 V 1~																																	
Maximum transient current (peak)	10 Apk																																	
Maximum continuous current (rms)	4 Arms																																	
Interface	CANopen, Modbus RTU, P/D, +/-10V																																	
Card	Reference	Serial number	Version	Vendor name																														
Device	LXM05AD10M2	01610002197	P840.10 V1.1IE20	Telemecanique																														
Control Board				Telemecanique																														
Motor	BSH0701P.1 Family : BSH Size : 070 Length : 1	2006040180		Telemecanique																														

<p>7</p>	<p>You can select the relevant drive by double-clicking it in the project browser on the left-hand side.</p>																																																							
<p>8</p>	<p>The parameters can be displayed in list format or in page view.</p> <p>You can switch the view via Display->List or Pages from the menu bar.</p>																																																							
<p>9</p>	<p>Select Simply start->Basic configuration.</p> <p>And in the Command interface selection field, you should select: CANOpenDevice.</p> <p>The servo drive will now be enabled for control via CANopen.</p> <p>In order for this change to take effect on the Lexium 05, you will need to switch the device off and then back on again.</p> <p>Click OK to close the message window.</p>	 <table border="1" data-bbox="869 1153 1444 1332"> <thead> <tr> <th>Code</th> <th>Short label</th> <th>Long label</th> <th>Minimum val</th> <th>Maximum val</th> <th>Current Value</th> </tr> </thead> <tbody> <tr> <td>ID_DEVC</td> <td>DEVcmdInterf</td> <td>Command interface selection</td> <td>-</td> <td>-</td> <td>IDDevice</td> </tr> <tr> <td>ID_MAX</td> <td>CTRL_r_max</td> <td>Current limitation</td> <td>0.00 Apk</td> <td>6.65 Apk</td> <td>none</td> </tr> <tr> <td>ID_IMHA</td> <td>LIM_l_maxHalt</td> <td>Current limiting for Halt</td> <td>0.00 Apk</td> <td>6.65 Apk</td> <td>IDDevice</td> </tr> <tr> <td>ID_IMQS</td> <td>LIM_l_maxQSTP</td> <td>Current limiting for Quick-Stop</td> <td>0.00 Apk</td> <td>6.65 Apk</td> <td>CANOpenDevice</td> </tr> <tr> <td>ID_LLIO</td> <td>IDLogicType</td> <td>Type of I/O (sink/source)</td> <td>-</td> <td>-</td> <td>source</td> </tr> <tr> <td>ID_M40</td> <td>IDdefaultMode</td> <td>Operating mode in 'Local'</td> <td>-</td> <td>-</td> <td>none</td> </tr> <tr> <td>ID_M422</td> <td>IDposInterfac</td> <td>Pos. interface signal selection</td> <td>-</td> <td>-</td> <td>ESIMoutput</td> </tr> <tr> <td>ID_NMAX</td> <td>CTRL_r_max</td> <td>Speed limitation</td> <td>0.1/min</td> <td>8000.1/min</td> <td>8000.1/min</td> </tr> </tbody> </table> 	Code	Short label	Long label	Minimum val	Maximum val	Current Value	ID_DEVC	DEVcmdInterf	Command interface selection	-	-	IDDevice	ID_MAX	CTRL_r_max	Current limitation	0.00 Apk	6.65 Apk	none	ID_IMHA	LIM_l_maxHalt	Current limiting for Halt	0.00 Apk	6.65 Apk	IDDevice	ID_IMQS	LIM_l_maxQSTP	Current limiting for Quick-Stop	0.00 Apk	6.65 Apk	CANOpenDevice	ID_LLIO	IDLogicType	Type of I/O (sink/source)	-	-	source	ID_M40	IDdefaultMode	Operating mode in 'Local'	-	-	none	ID_M422	IDposInterfac	Pos. interface signal selection	-	-	ESIMoutput	ID_NMAX	CTRL_r_max	Speed limitation	0.1/min	8000.1/min	8000.1/min
Code	Short label	Long label	Minimum val	Maximum val	Current Value																																																			
ID_DEVC	DEVcmdInterf	Command interface selection	-	-	IDDevice																																																			
ID_MAX	CTRL_r_max	Current limitation	0.00 Apk	6.65 Apk	none																																																			
ID_IMHA	LIM_l_maxHalt	Current limiting for Halt	0.00 Apk	6.65 Apk	IDDevice																																																			
ID_IMQS	LIM_l_maxQSTP	Current limiting for Quick-Stop	0.00 Apk	6.65 Apk	CANOpenDevice																																																			
ID_LLIO	IDLogicType	Type of I/O (sink/source)	-	-	source																																																			
ID_M40	IDdefaultMode	Operating mode in 'Local'	-	-	none																																																			
ID_M422	IDposInterfac	Pos. interface signal selection	-	-	ESIMoutput																																																			
ID_NMAX	CTRL_r_max	Speed limitation	0.1/min	8000.1/min	8000.1/min																																																			

<p>10</p>	<p>Initially, the change will be highlighted in red, but the display colour will change when you select:</p> <p>File->Save.</p>	<table border="1"> <thead> <tr> <th>Minimum value</th> <th>Maximum value</th> <th>Current Value</th> </tr> </thead> <tbody> <tr> <td>-</td> <td>-</td> <td><i>CANopenDevice</i></td> </tr> <tr> <td>0.00 Apk</td> <td>6.65 Apk</td> <td>6.65 Apk</td> </tr> <tr> <td>0.00 Apk</td> <td>6.65 Apk</td> <td>6.65 Apk</td> </tr> <tr> <td>0.00 Apk</td> <td>6.65 Apk</td> <td>6.65 Apk</td> </tr> </tbody> </table>  <table border="1"> <thead> <tr> <th>Minimum value</th> <th>Maximum value</th> <th>Current Value</th> </tr> </thead> <tbody> <tr> <td>-</td> <td>-</td> <td>CANopenDevice</td> </tr> <tr> <td>0.00 Apk</td> <td>6.65 Apk</td> <td>6.65 Apk</td> </tr> <tr> <td>0.00 Apk</td> <td>6.65 Apk</td> <td>6.65 Apk</td> </tr> <tr> <td>0.00 Apk</td> <td>6.65 Apk</td> <td>6.65 Apk</td> </tr> </tbody> </table>	Minimum value	Maximum value	Current Value	-	-	<i>CANopenDevice</i>	0.00 Apk	6.65 Apk	6.65 Apk	0.00 Apk	6.65 Apk	6.65 Apk	0.00 Apk	6.65 Apk	6.65 Apk	Minimum value	Maximum value	Current Value	-	-	CANopenDevice	0.00 Apk	6.65 Apk	6.65 Apk	0.00 Apk	6.65 Apk	6.65 Apk	0.00 Apk	6.65 Apk	6.65 Apk																								
Minimum value	Maximum value	Current Value																																																						
-	-	<i>CANopenDevice</i>																																																						
0.00 Apk	6.65 Apk	6.65 Apk																																																						
0.00 Apk	6.65 Apk	6.65 Apk																																																						
0.00 Apk	6.65 Apk	6.65 Apk																																																						
Minimum value	Maximum value	Current Value																																																						
-	-	CANopenDevice																																																						
0.00 Apk	6.65 Apk	6.65 Apk																																																						
0.00 Apk	6.65 Apk	6.65 Apk																																																						
0.00 Apk	6.65 Apk	6.65 Apk																																																						
<p>11</p>	<p>Make the following settings under Communication:</p> <p>CANopen address: 3 - 8 CANopen baud rate: 500 Modbus address: 1</p>	 <table border="1"> <thead> <tr> <th>Code</th> <th>Short label</th> <th>Long label</th> <th>Minimum</th> <th>Maximum</th> <th>Current Value</th> </tr> </thead> <tbody> <tr> <td>ID_ASH</td> <td>ID_AutoEnable</td> <td>Automatic Enable at PowerOn</td> <td>-</td> <td>-</td> <td>off</td> </tr> <tr> <td>ID_COAD</td> <td>CANadr</td> <td>CANopen address (node number)</td> <td>1</td> <td>127</td> <td>3</td> </tr> <tr> <td>ID_COBD</td> <td>CANbaud</td> <td>CANopen baud rate</td> <td>-</td> <td>-</td> <td>500KB</td> </tr> <tr> <td>ID_MBAD</td> <td>MBadr</td> <td>Modbus address</td> <td>1</td> <td>247</td> <td>1</td> </tr> <tr> <td>ID_MBBD</td> <td>MBbaud</td> <td>Modbus baud rate</td> <td>-</td> <td>-</td> <td>19.2KB</td> </tr> <tr> <td>ID_MBF0</td> <td>MBformat</td> <td>Modbus data format</td> <td>-</td> <td>-</td> <td>8Bit EvenParity 15stop</td> </tr> <tr> <td>ID_MBIW0</td> <td>MBword_order</td> <td>Modbus double word sequence</td> <td>-</td> <td>-</td> <td>HighLow</td> </tr> <tr> <td>ID_SMC</td> <td>DDCMcompatib</td> <td>Transition 3>4 (DriveCom)</td> <td>-</td> <td>-</td> <td>Automatic</td> </tr> </tbody> </table>	Code	Short label	Long label	Minimum	Maximum	Current Value	ID_ASH	ID_AutoEnable	Automatic Enable at PowerOn	-	-	off	ID_COAD	CANadr	CANopen address (node number)	1	127	3	ID_COBD	CANbaud	CANopen baud rate	-	-	500KB	ID_MBAD	MBadr	Modbus address	1	247	1	ID_MBBD	MBbaud	Modbus baud rate	-	-	19.2KB	ID_MBF0	MBformat	Modbus data format	-	-	8Bit EvenParity 15stop	ID_MBIW0	MBword_order	Modbus double word sequence	-	-	HighLow	ID_SMC	DDCMcompatib	Transition 3>4 (DriveCom)	-	-	Automatic
Code	Short label	Long label	Minimum	Maximum	Current Value																																																			
ID_ASH	ID_AutoEnable	Automatic Enable at PowerOn	-	-	off																																																			
ID_COAD	CANadr	CANopen address (node number)	1	127	3																																																			
ID_COBD	CANbaud	CANopen baud rate	-	-	500KB																																																			
ID_MBAD	MBadr	Modbus address	1	247	1																																																			
ID_MBBD	MBbaud	Modbus baud rate	-	-	19.2KB																																																			
ID_MBF0	MBformat	Modbus data format	-	-	8Bit EvenParity 15stop																																																			
ID_MBIW0	MBword_order	Modbus double word sequence	-	-	HighLow																																																			
ID_SMC	DDCMcompatib	Transition 3>4 (DriveCom)	-	-	Automatic																																																			
<p>12</p>	<p>To transfer the settings to the Lexium 05, select</p> <p>Configuration-> Save to EEPROM</p>																																																							
<p>13</p>	<p>Click OK to confirm the message windows that appear.</p> <p>The transfer is complete.</p>	 																																																						

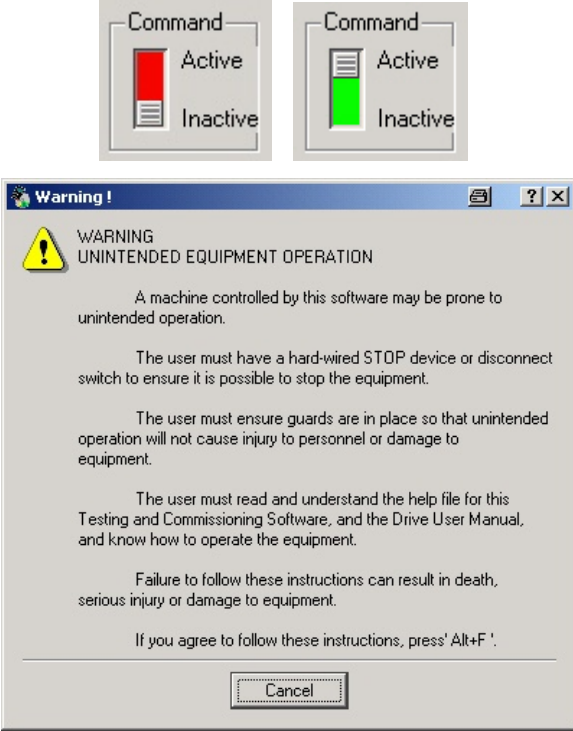
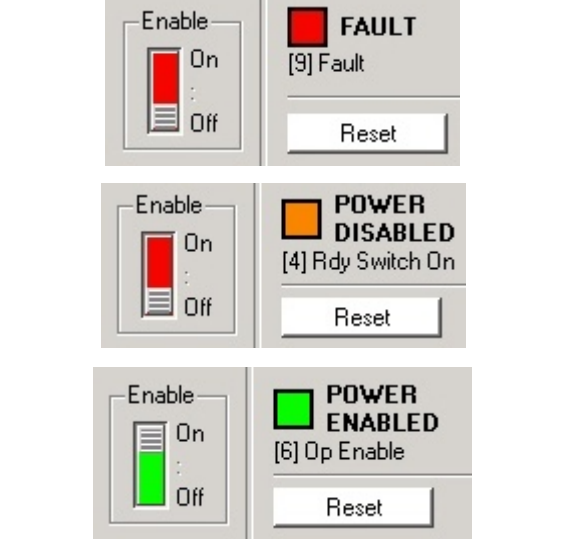
**Online
Lexium 05
Control**

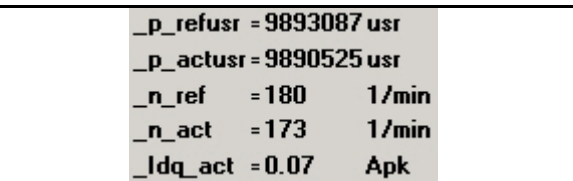
<p>1</p>	<p>You have the option of controlling the servo drive via the PowerSuite software.</p> <p>To do this, you must first set the Command switch to Active.</p> <p>Press Alt+F to confirm the security warning.</p>	 <p>The screenshot shows two 'Command' control panels. The left one has a red bar and 'Active' text, while the right one has a green bar and 'Active' text. Below them is a 'Warning!' dialog box with a yellow warning icon. The dialog text reads: 'WARNING UNINTENDED EQUIPMENT OPERATION. A machine controlled by this software may be prone to unintended operation. The user must have a hard-wired STOP device or disconnect switch to ensure it is possible to stop the equipment. The user must ensure guards are in place so that unintended operation will not cause injury to personnel or damage to equipment. The user must read and understand the help file for this Testing and Commissioning Software, and the Drive User Manual, and know how to operate the equipment. Failure to follow these instructions can result in death, serious injury or damage to equipment. If you agree to follow these instructions, press 'Alt+F'.' A 'Cancel' button is at the bottom.</p>
<p>2</p>	<p>Then set the Enable switch to On.</p> <p>Potential errors can be acknowledged by clicking Reset.</p>	 <p>The screenshot shows three 'Enable' control panels, each with a red bar and 'On' text. To the right are three status panels: 'FAULT [9] Fault' with a red square and a 'Reset' button; 'POWER DISABLED [4] Rdy Switch On' with an orange square and a 'Reset' button; and 'POWER ENABLED [6] Op Enable' with a green square and a 'Reset' button.</p>
<p>3</p>	<p>Test run can be used to activate the servo drive. Test stop can be used to stop it again.</p>	 <p>The screenshot shows four buttons: a green 'Test run' button, a grey 'Test run' button, a grey 'Test stop' button, and a red 'Test stop' button.</p>
<p>4</p>	<p>Neg. and Pos. can be used to rotate the drive.</p>	 <p>The screenshot shows a dropdown menu with 'use fastMan' selected, and two buttons labeled 'Neg' and 'Pos'. Below them is the text 'Jog control'.</p>
<p>5</p>	<p>Information about the speed and position is displayed on the bottom right.</p>	 <p>The screenshot shows a grey box with the following text: <pre> _p_refusr = 9893087 usr _p_actusr = 9890525 usr _n_ref = 180 1/min _n_act = 173 1/min _ldq_act = 0.07 Apk </pre> </p>

Altivar 71

Introduction

The settings for the ATV71 variable speed drive can either be made manually using the graphic display on the device or by means of the PowerSuite configuration software.

This section describes how to make the basic communication parameter settings manually, via the operator panel. You need to do this in order to access the VSD from the software.

The parameterization option using the PowerSuite software is then described.

Preconditions





Before carrying out the steps described below, you must ensure that:

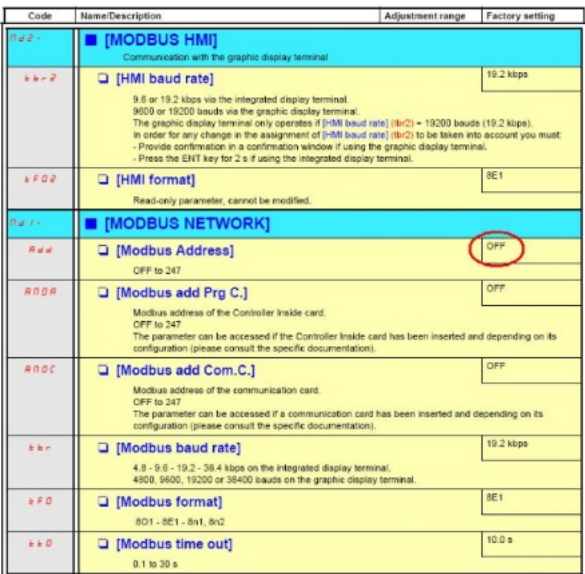
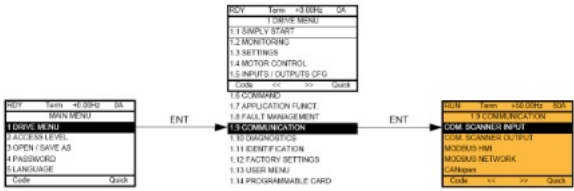

- The PowerSuite parameterization software is installed on your PC.
- The variable speed drive is connected to the power supply.
- The PC is connected to the variable speed drive via the communication cable.

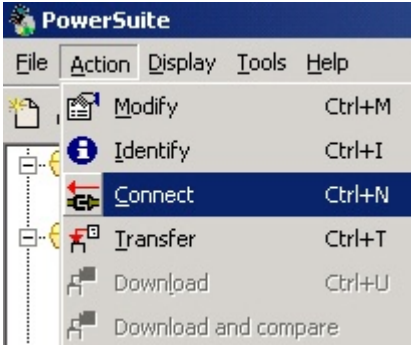
ATV71 Manual Setup (Modbus)

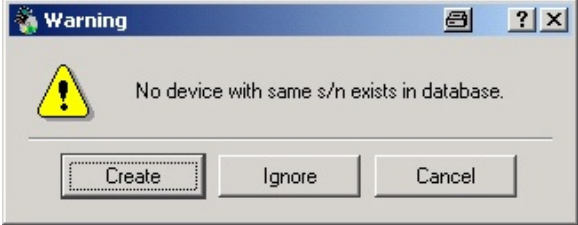

<p>1</p> <p>The Modbus address on the interface is factory-set to OFF, i.e., the interface is inactive.</p> <p>Here is an extract from the ATV71 installation manual. (A PDF is supplied with the ATV71 on CD).</p>	 <table border="1"> <thead> <tr> <th>Code</th> <th>Name/Description</th> <th>Adjustment range</th> <th>Factory setting</th> </tr> </thead> <tbody> <tr> <td colspan="4">[MODBUS HMI]</td> </tr> <tr> <td colspan="4">Communication with the graphic display terminal</td> </tr> <tr> <td>h b - 2</td> <td>[HMI baud rate]</td> <td>19.2 kbps</td> <td>19.2 kbps</td> </tr> <tr> <td colspan="4">9.6 or 19.2 kbps via the integrated display terminal. 9600 or 19200 bauds via the graphic display terminal. The graphic display terminal only operates if [HMI baud rate] (h b r 2) = 19200 bauds (19.2 kbps). In order for any change in the assignment of [HMI baud rate] (h b r 2) to be taken into account you must: - Provide confirmation in a confirmation window if using the graphic display terminal. - Press the ENT key for 2 s if using the integrated display terminal.</td> </tr> <tr> <td>h F 0 2</td> <td>[HMI format]</td> <td>BE1</td> <td>BE1</td> </tr> <tr> <td colspan="4">Read-only parameter, cannot be modified.</td> </tr> <tr> <td colspan="4">[MODBUS NETWORK]</td> </tr> <tr> <td>h a a</td> <td>[Modbus Address]</td> <td>OFF to 247</td> <td>OFF</td> </tr> <tr> <td colspan="4">Modbus address of the Controller inside card. OFF to 247 The parameter can be accessed if the Controller inside card has been inserted and depending on its configuration (please consult the specific documentation).</td> </tr> <tr> <td>h a 0 a</td> <td>[Modbus add Prg C.]</td> <td>OFF</td> <td>OFF</td> </tr> <tr> <td colspan="4">Modbus address of the Controller inside card. OFF to 247 The parameter can be accessed if a communication card has been inserted and depending on its configuration (please consult the specific documentation).</td> </tr> <tr> <td>h a 0 c</td> <td>[Modbus add Com.C.]</td> <td>OFF</td> <td>OFF</td> </tr> <tr> <td colspan="4">Modbus address of the communication card. OFF to 247 The parameter can be accessed if a communication card has been inserted and depending on its configuration (please consult the specific documentation).</td> </tr> <tr> <td>h b -</td> <td>[Modbus baud rate]</td> <td>19.2 kbps</td> <td>19.2 kbps</td> </tr> <tr> <td colspan="4">4.8 - 9.6 - 19.2 - 38.4 kbps on the integrated display terminal. 4800, 9600, 19200 or 38400 bauds on the graphic display terminal.</td> </tr> <tr> <td>h F 0</td> <td>[Modbus format]</td> <td>BE1</td> <td>BE1</td> </tr> <tr> <td colspan="4">801 - BE1 - Bin1, Bin2</td> </tr> <tr> <td>h t 0</td> <td>[Modbus time out]</td> <td>10.0 s</td> <td>10.0 s</td> </tr> <tr> <td colspan="4">0.1 to 30 s</td> </tr> </tbody> </table>	Code	Name/Description	Adjustment range	Factory setting	[MODBUS HMI]				Communication with the graphic display terminal				h b - 2	[HMI baud rate]	19.2 kbps	19.2 kbps	9.6 or 19.2 kbps via the integrated display terminal. 9600 or 19200 bauds via the graphic display terminal. The graphic display terminal only operates if [HMI baud rate] (h b r 2) = 19200 bauds (19.2 kbps). In order for any change in the assignment of [HMI baud rate] (h b r 2) to be taken into account you must: - Provide confirmation in a confirmation window if using the graphic display terminal. - Press the ENT key for 2 s if using the integrated display terminal.				h F 0 2	[HMI format]	BE1	BE1	Read-only parameter, cannot be modified.				[MODBUS NETWORK]				h a a	[Modbus Address]	OFF to 247	OFF	Modbus address of the Controller inside card. OFF to 247 The parameter can be accessed if the Controller inside card has been inserted and depending on its configuration (please consult the specific documentation).				h a 0 a	[Modbus add Prg C.]	OFF	OFF	Modbus address of the Controller inside card. OFF to 247 The parameter can be accessed if a communication card has been inserted and depending on its configuration (please consult the specific documentation).				h a 0 c	[Modbus add Com.C.]	OFF	OFF	Modbus address of the communication card. OFF to 247 The parameter can be accessed if a communication card has been inserted and depending on its configuration (please consult the specific documentation).				h b -	[Modbus baud rate]	19.2 kbps	19.2 kbps	4.8 - 9.6 - 19.2 - 38.4 kbps on the integrated display terminal. 4800, 9600, 19200 or 38400 bauds on the graphic display terminal.				h F 0	[Modbus format]	BE1	BE1	801 - BE1 - Bin1, Bin2				h t 0	[Modbus time out]	10.0 s	10.0 s	0.1 to 30 s			
Code	Name/Description	Adjustment range	Factory setting																																																																														
[MODBUS HMI]																																																																																	
Communication with the graphic display terminal																																																																																	
h b - 2	[HMI baud rate]	19.2 kbps	19.2 kbps																																																																														
9.6 or 19.2 kbps via the integrated display terminal. 9600 or 19200 bauds via the graphic display terminal. The graphic display terminal only operates if [HMI baud rate] (h b r 2) = 19200 bauds (19.2 kbps). In order for any change in the assignment of [HMI baud rate] (h b r 2) to be taken into account you must: - Provide confirmation in a confirmation window if using the graphic display terminal. - Press the ENT key for 2 s if using the integrated display terminal.																																																																																	
h F 0 2	[HMI format]	BE1	BE1																																																																														
Read-only parameter, cannot be modified.																																																																																	
[MODBUS NETWORK]																																																																																	
h a a	[Modbus Address]	OFF to 247	OFF																																																																														
Modbus address of the Controller inside card. OFF to 247 The parameter can be accessed if the Controller inside card has been inserted and depending on its configuration (please consult the specific documentation).																																																																																	
h a 0 a	[Modbus add Prg C.]	OFF	OFF																																																																														
Modbus address of the Controller inside card. OFF to 247 The parameter can be accessed if a communication card has been inserted and depending on its configuration (please consult the specific documentation).																																																																																	
h a 0 c	[Modbus add Com.C.]	OFF	OFF																																																																														
Modbus address of the communication card. OFF to 247 The parameter can be accessed if a communication card has been inserted and depending on its configuration (please consult the specific documentation).																																																																																	
h b -	[Modbus baud rate]	19.2 kbps	19.2 kbps																																																																														
4.8 - 9.6 - 19.2 - 38.4 kbps on the integrated display terminal. 4800, 9600, 19200 or 38400 bauds on the graphic display terminal.																																																																																	
h F 0	[Modbus format]	BE1	BE1																																																																														
801 - BE1 - Bin1, Bin2																																																																																	
h t 0	[Modbus time out]	10.0 s	10.0 s																																																																														
0.1 to 30 s																																																																																	
<p>2</p> <p>From the Main Menu on the ATV71 operator panel, select</p> <ul style="list-style-type: none"> → 1 Drive Menu → 1.9 Communication → Modbus Network → Address Modbus = OFF → Press the selector switch. → Turn the selector switch to MB-ADR = 1 and → Press the selector switch to confirm. 	 <pre> graph LR MM[Main Menu] -- ENT --> DM[Drive Menu] DM -- ENT --> COM[Communication] COM -- ENT --> MBN[Modbus Network] MBN -- ENT --> AM[Address Modbus] </pre>																																																																																

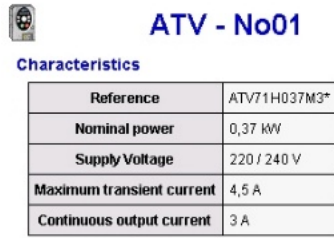
**PowerSuite
with ATV71**

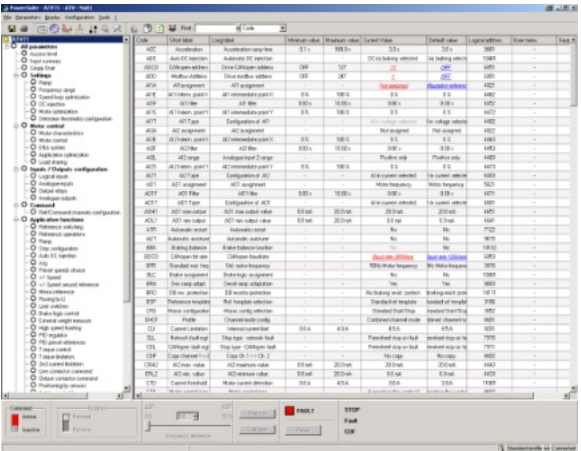
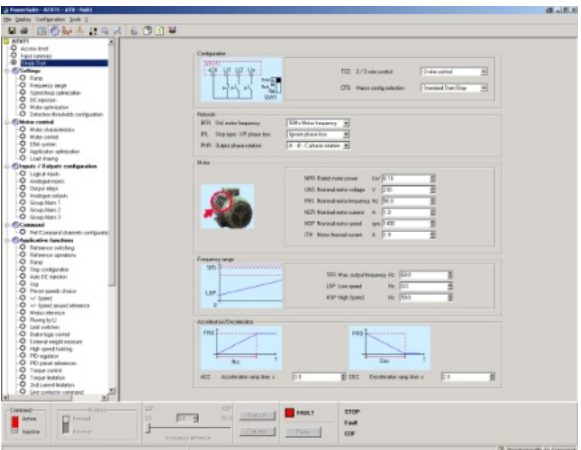
<p>1</p>	<p>After starting up PowerSuite, select the directory CEM_M340. Then select:</p> <p>Action->Connect</p> <p>from the menu bar, or click on the corresponding icon, to establish a connection to the device.</p>	 <p>The screenshot shows the 'Action' menu in the PowerSuite application. The menu items are: Modify (Ctrl+M), Identify (Ctrl+I), Connect (Ctrl+N), Transfer (Ctrl+T), Download (Ctrl+U), and Download and compare. The 'Connect' option is highlighted in blue.</p>
<p>2</p>	<p>Before the connection is established, you must press ALT+F to confirm that you accept the terms of the security warning.</p>	 <p>The screenshot shows a 'Warning !' dialog box with a yellow warning icon. The text reads: 'WARNING UNINTENDED EQUIPMENT OPERATION. A machine controlled by this software may be prone to unintended operation. The user must have a hard-wired STOP device or disconnect switch to ensure it is possible to stop the equipment. The user must ensure guards are in place so that unintended operation will not cause injury to personnel or damage to equipment. The user must read and understand the help file for this Testing and Commissioning Software, and the Drive User Manual, and know how to operate the equipment. Failure to follow these instructions can result in death, serious injury or damage to equipment. If you agree to follow these instructions, press! Alt+F !'. There is a 'Cancel' button at the bottom.</p>
<p>3</p>	<p>You will receive a warning that there is no record of the new device.</p> <p>Select Create.</p>	 <p>The screenshot shows a 'Warning' dialog box with a yellow warning icon. The text reads: 'No device with same s/n exists in database.'. There are three buttons: 'Create', 'Ignore', and 'Cancel'. The 'Create' button is highlighted.</p>
<p>4</p>	<p>Next, you need to enter the name of the configuration or device.</p>	 <p>The screenshot shows a 'New name' dialog box with a text input field containing 'ATV - No01'. There are 'OK' and 'Cancel' buttons at the bottom.</p>
<p>5</p>	<p>The data is read out from the Altivar 71.</p>	 <p>The screenshot shows a 'Please wait...' dialog box with a progress bar. The text reads: 'Please wait... Reading from drive'. The progress bar is at 10%. There is a 'Cancel' button at the bottom.</p>

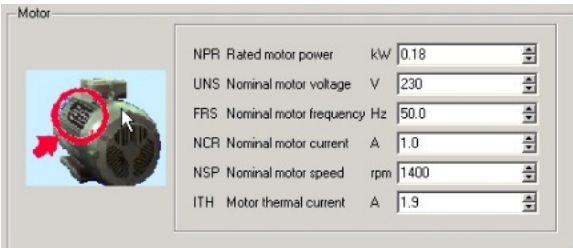
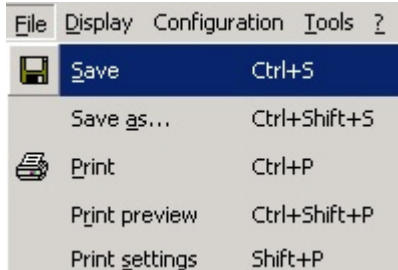
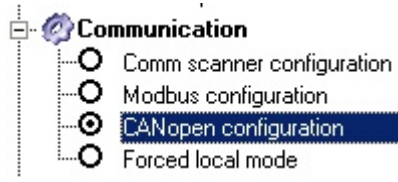
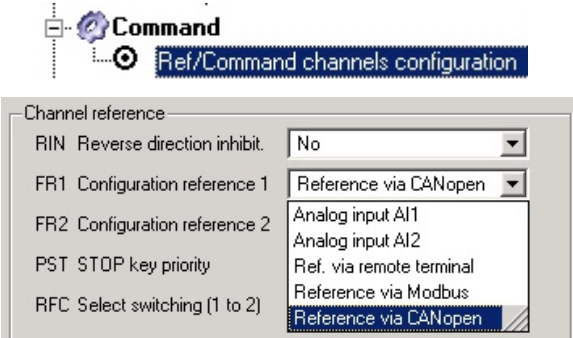
6	<p>Once the transfer is complete, the Characteristics will be displayed.</p>	 <p>ATV - No01</p> <p>Characteristics</p> <table border="1"> <tr> <td>Reference</td> <td>ATV71H037M3*</td> </tr> <tr> <td>Nominal power</td> <td>0,37 kW</td> </tr> <tr> <td>Supply Voltage</td> <td>220 / 240 V</td> </tr> <tr> <td>Maximum transient current</td> <td>4,5 A</td> </tr> <tr> <td>Continuous output current</td> <td>3 A</td> </tr> </table>	Reference	ATV71H037M3*	Nominal power	0,37 kW	Supply Voltage	220 / 240 V	Maximum transient current	4,5 A	Continuous output current	3 A										
Reference	ATV71H037M3*																					
Nominal power	0,37 kW																					
Supply Voltage	220 / 240 V																					
Maximum transient current	4,5 A																					
Continuous output current	3 A																					
7	<p>The Structure and Configuration data of the ATV71 are shown here.</p>	<p>Structure</p> <table border="1"> <thead> <tr> <th>Card</th> <th>Reference</th> <th>Serial number</th> <th>Version</th> <th>Vendor name</th> </tr> </thead> <tbody> <tr> <td>Device</td> <td>ATV71H037M3*</td> <td>XXX5 32 000 149</td> <td>V1.1E04</td> <td>TELEMECANIQUE</td> </tr> <tr> <td>Control Board</td> <td>VX4A7100/101</td> <td>XXX5 25 000 902</td> <td>V1.1E03</td> <td>TELEMECANIQUE</td> </tr> <tr> <td>Power board</td> <td></td> <td>XXX5 10 000 090</td> <td>V1.1E03</td> <td>TELEMECANIQUE</td> </tr> </tbody> </table> <p>Configuration(s)</p> <p>Name: ATV - No01 Software release: V1.1E04</p>	Card	Reference	Serial number	Version	Vendor name	Device	ATV71H037M3*	XXX5 32 000 149	V1.1E04	TELEMECANIQUE	Control Board	VX4A7100/101	XXX5 25 000 902	V1.1E03	TELEMECANIQUE	Power board		XXX5 10 000 090	V1.1E03	TELEMECANIQUE
Card	Reference	Serial number	Version	Vendor name																		
Device	ATV71H037M3*	XXX5 32 000 149	V1.1E04	TELEMECANIQUE																		
Control Board	VX4A7100/101	XXX5 25 000 902	V1.1E03	TELEMECANIQUE																		
Power board		XXX5 10 000 090	V1.1E03	TELEMECANIQUE																		
8	<p>You can select the relevant drive in the project browser.</p>																					
9	<p>The parameters can be displayed in list format.</p>																					
10	<p>Alternatively, they can be displayed and modified using graphical support.</p> <p>You can switch between these via Display->List or by selecting Pages.</p> <p>The view shown here can be accessed via Simply Start.</p>																					

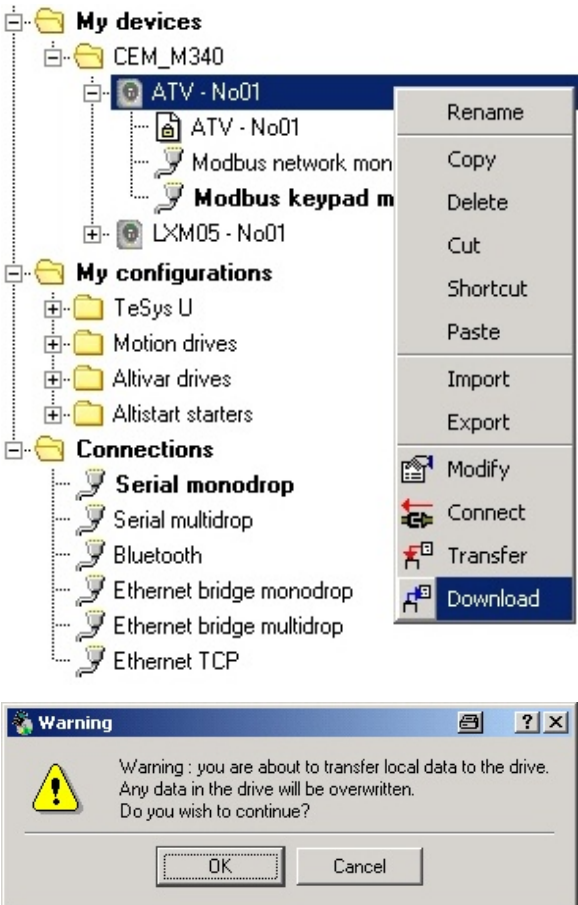
11	Enter the motor data for the motor here, for example.	
12	The data can be saved by selecting File->Save.	
13	In the Communication area, the six ATV71 drives differ in relation to the CANopen address. Address 11 - 16 Baud rate 500 kBaud	
14	In the Command area, enter the location from which control commands originate. In this application, the reference is via CANopen. Select: FR1->Reference via CANopen.	

<p>15</p>	<p>Use the menu item</p> <p>Action->Download</p> <p>to transfer the current version of the PowerSuite settings to the Altivar 71.</p> <p>You can also right-click to select this item.</p> <p>Click OK to confirm the warning that follows.</p>	
<p>16</p>	<p>The PowerSuite software can also be used to control the variable speed drives.</p>	

TeSysU

Introduction

The TeSysU motor starter consists of a power base, control unit and communication module. No software is required for parameterization in the case of this application.

Layout

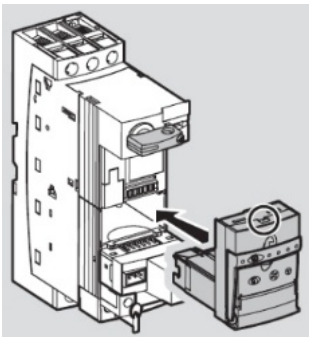
1	<p>The TeSysU motor starter consists of a</p> <p>Power base Control unit and Communication module.</p> <p>The individual components can be assembled or exchanged without the need for tools.</p>	
---	--	--

Setting the Communication Parameters

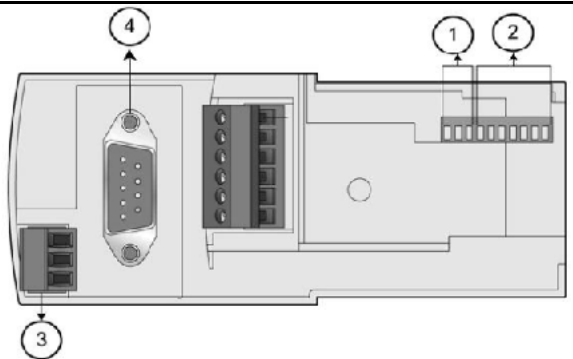
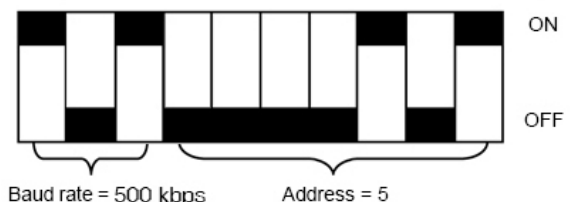
1	<p>The communication module has DIP switches, which can be used to set the communication parameters.</p> <p>For CANopen, the relevant parameters are the address and baud rate.</p>	 <p>1 Baud rate 2 Address 3 Power base connector 4 CAN bus connector</p>
2	<p>The baud rate is set to 500 kBaud.</p> <p>The two TeSysU motor starters used in this application have the following addresses:</p> <p>1st TeSysU: 17 2nd TeSysU: 18</p>	<p>Example:</p>  <p>Baud rate = 500 kbps Address = 5</p>

3

Below are the possible switch settings:

SW10	SW9	SW8	Baud Rate
0	0	0	10 kbps
0	0	1	20 kbps
0	1	0	50 kbps
0	1	1	125 kbps
1	0	0	250 kbps (default)
1	0	1	500 kbps
1	1	0	800 kbps
1	1	1	1,000 kbps

SW7	SW6	SW5	SW4	SW3	SW2	SW1	Address
0	0	0	0	0	0	0	Not valid
0	0	0	0	0	0	1	1 (default)
0	0	0	0	0	1	0	2
0	0	0	0	0	1	1	3
0	0	0	0	1	0	0	4
0	0	0	0	1	0	1	5
...							
1	1	1	1	1	1	1	127

Performance

Scan and Cycle time

Using the described configuration and the example application code for the Modicon M340 PLC, a cycle time of 8 milliseconds was attained. The memory usage in this system with the specified PLC was 49% for system data and 10% for program data.

Appendix

Detailed Component List

Hardware Components					
	Pos.	Amt.	Description	Part Number	Rev./ Vers.
Performance	1.01	1	3-pin master switch 36 kA NS100N	29003	
	1.02	1	Trip block	29035	
	1.03	1	Terminal cover	29321	
	1.04	1	Rotary drive	29340	
	1.05	1	230/24 V DC, 10 A power supply unit	ABL7RP2410	
PLC	2.01	1	PLC CPU with CANopen and Ethernet	BMXP342030	
	2.02	1	Rack with 8 slots	BMXXBP0800	
	2.03	1	Power supply	BMXCPS3020	
	2.04	2	Digital input card, 32 channels	BMXDDI3202K	
	2.05	1	Digital output card, 32 channels	BMXDDO3202K	
	2.06	1	Digital input/output card, 16 + 16 channels	BMXDDM3202K	
	2.07	1	Analog output card, 4 channels	BMXAMI0410	
	2.08	1	Analog output card, 2 channels	BMXAMO0210	
	2.09	4	Telefast connection cable	BMXFCC303	
	2.10	8	Telefast block with 16 inputs or 16 outputs	ABE7H16R21	
	2.11	2	20-pin terminal block	BMXF TB2020	
HMI	3.01	1	Magelis 5.7" operator terminal	XBTGT2330	PV 1.0
Drives	4.01	2	Lexium 15 LP, 1.2 kW, 230 V AC, single-phase	LXM15LD28M3	SV 1.45
	4.02	2	CANopen adapter for Lexium 15	AMO2CA001V00	
	4.03	6	Lexium 05, 0.75 kW, 230 V AC, single-phase	LXM05AD10M2	V 1.1 ie25
	4.04	6	Altivar 71, 0.75 kW, 400 V AC, three-phase	ATV71H075N4	V1.1 ie04
	4.05	2	Servo for Lexium 15	SER39A4L7SRAA	
	4.06	6	Servo for Lexium 05	BSH0702P02A2A	
	4.07	8	Motor cable for LXM15 and LXM05, 3 m	VW3M5101R30	
	4.08	2	Encoder cable for LXM15, 3 m	VW3M8301R30	
	4.09	6	Encoder cable for LXM05, 3 m	VW3M8101R30	
	4.10	2	TeSysU power base, 12 A 400 V	LUB12	
	4.11	2	Advanced control unit	LUCB1XBL	
	4.12	2	CANopen adapter for TeSysU	LULC08	FW 1.2
	4.13	2	Coil wiring kit	LU9BN11C	

Hardware-Components					
	Pos.	Amt.	Description	Part Number	Rev./Vers.
Safety Emergency Off	5.01	1	Safety controller, 16 inputs, CANopen	XPSMC16ZC	
	5.02	1	Terminal block for safety controller	XPSMCTS16	
	5.03	1	Safety expansion module	XPSECP5131	
CANopen	6.01	3	CANopen TAP 2x RJ45	VW3CANTAP2	
	6.02	1	CANopen TAP 4x SubD9	VW3CANTDM4	
	6.03	6	CANopen connection cable RJ45	VW3CANCARR1	
	6.04	1	CANopen cable 100m	TCXCANCA100	
	6.05	1	CANopen 90°connector with add. port	TSXCANKCDF90TP	
	6.06	3	CANopen 90° connector	TSXCANKCDF90T	
	6.07	8	CANopen 180° connector	TSXCANKCFD180T	
	6.08	6	CANopen adapter for ATV71	VW3CANA71	
Ethernet	7.01	1	ConneXium Ethernet switch	499NES25100	
	7.02	2	ConneXium Ethernet cable, 5m	490NTW00005	
Cable	8.01	1	PLC/PC USB connection cable	BMXXCAUSB018	
	8.02	1	PC/HMI USB connection cable	XBTZG935	
	8.03	1	Serial connection cable	TSXPCX1031	
	8.04	1	Safety controller connection adapter	XPSMCCPC	
	8.05	1	PowerSuite connection cable, serial	VW3A8106	
	8.06	1	UniLink connection cable, serial	VW3M8601R30	

Software Components					
	Pos.	Amt.	Description	Part Number	Rev./Vers.
	1.01	1	Unity Pro	UNYSPUEFUCD30	V 3.00
	1.02	1	Vijeo Designer	VJDSPULFUCDV44M	V 4.40
	1.03	1	SafetySuite	XPSMCWIN	V 1.00
	1.04	2	UniLink L	Supplied with LXM15	V 1.50
	1.05	1	PowerSuite	VW3A8104	V 2.30

Component Protection Classes

Positioning
Protection
Class

Component	In Field, On Site			Cabinet		
	IP54	IP65	IP67	Front	IP65	Inside
	IP55			IP20		
Modicon M340 PLC						X
Magelis operator terminal						X
Lexium 15 servo drive						X
Lexium 05 servo drive						X
Altivar 71 variable speed drive						X
Master and maintenance switch		X				
Emergency Off pushbutton housing		X				
Contact, 24 V DC operated, 3-pin AC 3, 1x N/O + 1x N/C						X
Illuminated pushbuttons, all colours, flat		X			X	X
Auxiliary switch module with LED + 1 auxiliary switch (1x NO), all colours						X
Label holder 30x40, all texts		X				
Miniature circuit breaker, all types and ratings						X
Motor protection switches, all types and ratings						X
Phaseo power supply 24 V DC						X
Servo for Lexium 15/Lexium 05		X				

Component Features

Components

Programmable logic controller – Modicon M340

- For complex machines in medium-sized infrastructures
- CPU with up to two integrated bus interfaces (CANopen, TCP/IP and/or Modbus)
- Unity Pro software used for programming
- Flexible width with 4, 6, 8 or 12 slots
- 24 V DC or 100 – 240 V AC power supply
- Cards available for digital or analog I/O, counters, communication and networks
- Compact card dimensions: 32 x 100 x 93 mm (W x H x D)
- USB programming connection
- Large internal memory and slot for additional SD memory card



Preventa Safety Controller XPSMC16ZC

- For meeting up to Category 4 safety functions, in accordance with the EN 954-1 standard
- XPSMCWIN software is used to configure the safety functions (22 certified safety functions)
- Integrated CANopen port
- Two versions with 16 (XPSMC16ZC) or 32 (XPSMC32ZC) independent safety inputs
- 4 relay and 6 static outputs
- 24 V DC supply voltage
- Dimensions: 74 x 151 x 153 mm (W x H x D)



Components Lexium 15 LP servo drive (low power)

- From 0.9 kW to 42.5 kW
- 4 configurable logic inputs and 2 configurable logic outputs; can be extended using option cards.
- 2 analog inputs
- Integrated position controller
- Integrated line filter and brake resistors
- Simplified parameterization with UniLink software:
 - Settings
 - Programming of motion control
 - Bode diagram and oscilloscope
 - Configuration of motion task table
- 8 operating modes as standard: Manual operation, point-to-point operation, connectable motion tasks, electronic gears, speed control (analog or digital), torque control (analog or digital) and a number of encoder interfaces (SSI, EnDat®, Hiperface®, pulse/direction, etc.)
- The "Safe Stop" (Power Removal) function ensures immediate shutdown and prevents the servo motor from being started accidentally.
- High safety level integrated in accordance with EN 954-1: Category 1 or 3
- Communication: CANopen integrated, Profibus DP, Modbus Plus, FIPIO and Sercos



There are three different versions:

- Lexium 15 LP (low power):
 - From 0.9 kW to 4.3 kW
 - 1.5 A/3 A and 6 A with 3-phase power supply, 200 V to 480 V
 - 3 A/6 A and 10 A with 1- or 3-phase power supply, 240 V.
 - Up to 200 programmable and connectable motion tasks
- Lexium 15 MP (medium power):
 - From 5.7 kW to 11.4 kW
 - 10 A/14 A and 20 A with 3-phase power supply, 200 V to 480 V
 - Up to 180 programmable and connectable motion tasks
- Lexium 15 HP (high power):
 - From 22.3 kW to 42.5 kW
 - 40 A/70 A with 3-phase power supply, 200 V to 480 V
 - Up to 180 programmable and connectable motion tasks

Components Lexium 05 servo drive

- Voltage range:
 - Single-phase 100 – 120 V AC or 200 – 240 V AC
 - Three-phase 200 – 240 V AC or 380 – 480 V AC
- Power: 0.4 to 6 kW
- Rated torque: 0.5 to 36 Nm
- Rated speed: 1500 to 8000 rpm
- The compact design allows for space-saving installation of the drive in control cabinets or machines.
- Features the "Power Removal" (Safe Stop) safety function, which prevents the motor from being started accidentally. Category 3 with machine standard EN 954-1
- Lexium 05 servo amplifiers are fitted with a brake resistor as standard (an external brake resistor is optional)
- Quick control loop scan time: 62.5 μ s for current control loop, 250 μ s for speed control loop and 250 μ s for position control loop
- Operating modes: Point-to-point positioning (relative and absolute), electronic gears, speed profile, speed control and manual operation for straightforward setup.
- Control interfaces:
 - CANopen, Modbus or Profibus DP
 - Analog reference inputs with ± 10 V
 - Logic inputs and outputs
- The PowerSuite dialog tool enables the Lexium 05 servo drive to be configured, set and tested.



Altivar 71 variable speed drive

- Motor outputs from 0.37 kW to 500 kW with three voltage types:
 - 200 – 240 V, single-phase, from 0.37 kW – 5.5 kW
 - 200 – 240 V, three-phase, from 0.37 kW – 75 kW
 - 380 – 480 V, three-phase, from 0.75 kW – 500 kW
- Integrated interface for Modbus and CANopen
- Option cards available (up to 3 can be used simultaneously):
 - I/O expansion card
 - Communication card (Ethernet TCP/IP, Modbus/Uni-Telway, Fipio, Modbus Plus, Profibus DP, DeviceNet, INTERBUS, etc.)
 - Encoder interface card
- External options:
 - Braking modules, braking resistors, regenerative feedback modules, line reactors, motor reactors, sinusoidal filters and additional EMC input filters
- Integrated Safe Stop safety function (Power Removal), which prevents the motor from being started unintentionally. This function conforms to the machine standard EN 954-1 Category 3
- Removable graphic display terminal with 8 lines of plain text, each of which has 24 characters
- The PowerSuite dialog tool enables the Altivar 71 variable speed drive to be configured, set and tested.



Components

Magelis XBT GT 2xxx operator terminal

- High-definition display
 - Extremely sharp picture with 65,536 colours (TFT), 4,096 colours (STN) or 16 shades of gray, depending on the model
 - Adjustable contrast and brightness
 - QVGA, 320 x 240 pixel resolution
 - Analog touch screen so that objects can be positioned freely
- Compact
 - Small dimensions: Only 167 x 135 mm (W x H)
- Communicative
 - Two serial interfaces (RS232C & RS485);
 - One USB port
 - Optional 10/100 BaseT Ethernet port, depending on the model
- Can be used around the world
 - Multilingual applications – up to 10 languages can be used simultaneously
 - Numerous character sets available (Latin, Japanese, Chinese, Cyrillic, etc.)
- Save time when creating applications by using the Vijeo Designer configuration software
 - Library containing over 4,000 ready-to-use symbols, bitmaps and pictograms
 - Preconfigured objects for alarm lists, recipes and trends



Components **Unity Pro PLC programming software**

Unity Pro is the combined programming, testing and operating software for the Premium, Modicon M340 and Quantum PLCs.

- Unity Pro supports all 5 IEC 61131-3 programming languages as standard with all test functions via PC simulation or online on the PLC directly.
- Thanks to the icon variables that are independent of the memory, the structured data and the user function blocks, the application objects are mapped directly from the special components of the automated process.
- The user configures the Unity Pro operator screens within the application using the graphical libraries. Operator access is simple and direct.
- The test and maintenance functions are simplified thanks to animated graphic objects.
- For diagnosis, all system and application errors are displayed in plain text and in chronological order (date and time is provided at the origin) in a visualization window. You can return to the source of the conditions that have caused the error using the navigation function for troubleshooting.
- XML format, a Web standard for data exchange, has been used as the source format for Unity applications. The simple import/export functions mean that the entire application or parts of it can be exchanged with other software in your project.
- The converters integrated in Unity Pro automatically convert PL7 and Concept programs into Unity Pro programs.



Vijeo Designer PLC programming software

The user-friendly Vijeo Designer configuration software enables quick and easy project development with the aid of configuration windows. Vijeo Designer supports the processing of process data by allowing recourse to the XBT-G touch screen and to Java script.

Its features include:

- Navigator
- Library of animated graphic objects
- Online help
- Error report display
- Object attribute display
- Variable lists



Contact

Author	Telephone	E-Mail
Schneider Electric GmbH Machines and Process Architectures	+49 6182 81 2555	cm.systems@de.schneider-electric.com

Schneider Electric GmbH
Steinheimer Strasse 117
D - 63500 Seligenstadt
Germany

As standards, specifications and designs change from time to time, please ask for confirmation of the information given in this publication.