

Solid State Relays for Heaters

G3PE-Single-phase

Compact, Slim-profile SSRs with Heat Sinks. Models with No Zero Cross for a Wide Range of Applications.



- RoHS compliant.
- Models also available with no zero cross
- Surge pass protection improved surge dielectric strength for output currents. (OMRON testing)
- Compact with a slim profile.
- Mount to DIN Track or with screws.
- Conforms to UL, CSA, and EN standards (TÜV certification).

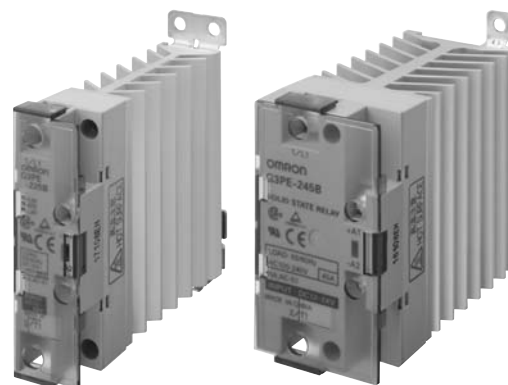

For the most recent information on models that have been certified for safety standards, refer to your OMRON website.

 Refer to *Safety Precautions* on page 18.

Ordering Information

List of Models

Number of phases	Insulation method	Operation indicator	Rated input voltage	Zero cross function	Applicable load *	Model
Single-phase	Phototriac coupler	Yes (yellow)	12 to 24 VDC	Yes	15 A, 100 to 240 VAC	G3PE-215B DC12-24
					25 A, 100 to 240 VAC	G3PE-225B DC12-24
					35 A, 100 to 240 VAC	G3PE-235B DC12-24
					45 A, 100 to 240 VAC	G3PE-245B DC12-24
				No	15 A, 100 to 240 VAC	G3PE-215BL DC12-24
					25 A, 100 to 240 VAC	G3PE-225BL DC12-24
					35 A, 100 to 240 VAC	G3PE-235BL DC12-24
					45 A, 100 to 240 VAC	G3PE-245BL DC12-24
				Yes	15 A, 200 to 480 VAC	G3PE-515B DC12-24
					25 A, 200 to 480 VAC	G3PE-525B DC12-24
					35 A, 200 to 480 VAC	G3PE-535B DC12-24
					45 A, 200 to 480 VAC	G3PE-545B DC12-24
				No	15 A, 200 to 480 VAC	G3PE-515BL DC12-24
					25 A, 200 to 480 VAC	G3PE-525BL DC12-24
					35 A, 200 to 480 VAC	G3PE-535BL DC12-24
					45 A, 200 to 480 VAC	G3PE-545BL DC12-24

* The applicable load current depends on the ambient temperature. For details, refer to *Load Current vs. Ambient Temperature* in *Engineering Data* on page 3.

G3PE-Single-phase

Specifications

Certification

UL508, CSA22.2 No.14, and EN60947-4-3

Ratings

Input (at an Ambient Temperature of 25°C)

Model	Item	Rated voltage	Operating voltage range	Rated input current	Voltage level	
					Must operate voltage	Must release voltage
G3PE-□□□B	12 to 24 VDC	9.6 to 30 VDC		7 mA max.	9.6 VDC max.	1.0 VDC max.
G3PE-□□□BL				15 mA max.		

Output

Item	Model	G3PE-215B(L)	G3PE-225B(L)	G3PE-235B(L)	G3PE-245B(L)	G3PE-515B(L)	G3PE-525B(L)	G3PE-535B(L)	G3PE-545B(L)
Rated load voltage		100 to 240 VAC (50/60 Hz)				200 to 480 VAC (50/60 Hz)			
Load voltage range		75 to 264 VAC (50/60 Hz)				180 to 528 VAC (50/60 Hz)			
Applicable load current *		0.1 to 15 A (at 40°C)	0.1 to 25 A (at 40°C)	0.5 to 35 A (at 25°C)	0.5 to 45 A (at 25°C)	0.1 to 15 A (at 40°C)	0.1 to 25 A (at 40°C)	0.5 to 35 A (at 25°C)	0.5 to 45 A (at 25°C)
Inrush current resistance		150 A (60 Hz, 1 cycle)	220 A (60 Hz, 1 cycle)	440 A (60 Hz, 1 cycle)		150 A (60 Hz, 1 cycle)	220 A (60 Hz, 1 cycle)	440 A (60 Hz, 1 cycle)	
Permissible I ² t (reference value)		121A ² s	260A ² s	1,260A ² s		128A ² s	1,350A ² s		6,600A ² s
Applicable load (resistive load)		3 kW (at 200 VAC)	5 kW (at 200 VAC)	7 kW (at 200 VAC)	9 kW (at 200 VAC)	6 kW (at 400 VAC)	10 kW (at 400 VAC)	14 kW (at 400 VAC)	18 kW (at 400 VAC)

* The applicable load current depends on the ambient temperature. For details, refer to *Load Current vs. Ambient Temperature* in *Engineering Data* on page 3.

Characteristics

Item	Model	G3PE-215B	G3PE-225B	G3PE-235B	G3PE-245B	G3PE-215BL	G3PE-225BL	G3PE-235BL	G3PE-245BL
Operate time		1/2 of load power source cycle + 1 ms max.				1 ms max.			
Release time		1/2 of load power source cycle + 1 ms max.							
Output ON voltage drop		1.6 V (RMS) max.							
Leakage current		10 mA max. (at 200 VAC)							
Insulation resistance		100 MΩ min. (at 500 VDC)							
Dielectric strength		2,500 VAC, 50/60 Hz for 1 min							
Vibration resistance		10 to 55 to 10 Hz, 0.375-mm single amplitude (0.75-mm double amplitude) (Mounted to DIN track)							
Shock resistance		Destruction: 294 m/s ² (Mounted to DIN track)							
Ambient storage temperature		-30 to 100°C (with no icing or condensation)							
Ambient operating temperature		-30 to 80°C (with no icing or condensation)							
Ambient operating humidity		45% to 85%							
Weight		Approx. 240 g		Approx. 400 g		Approx. 240 g		Approx. 400 g	

Model	Item	G3PE-515B	G3PE-525B	G3PE-535B	G3PE-545B	G3PE-515BL	G3PE-525BL	G3PE-535BL	G3PE-545BL
Operate time		1/2 of load power source cycle + 1 ms max.				1 ms max.			
Release time		1/2 of load power source cycle + 1 ms max.							
Output ON voltage drop		1.8 V (RMS) max.							
Leakage current		20 mA max. (at 480 VAC)							
Insulation resistance		100 MΩ min. (at 500 VDC)							
Dielectric strength		2,500 VAC, 50/60 Hz for 1 min							
Vibration resistance		10 to 55 to 10 Hz, 0.375-mm single amplitude (0.75-mm double amplitude) (Mounted to DIN track)							
Shock resistance		Destruction: 294 m/s ² (Mounted to DIN track)							
Ambient storage temperature		-30 to 100°C (with no icing or condensation)							
Ambient operating temperature		-30 to 80°C (with no icing or condensation)							
Ambient operating humidity		45% to 85%							
Weight		Approx. 240 g		Approx. 400 g		Approx. 240 g		Approx. 400 g	

Engineering Data

Input Voltage vs. Input Impedance and Input Voltage vs. Input Current

G3PE-2□□B

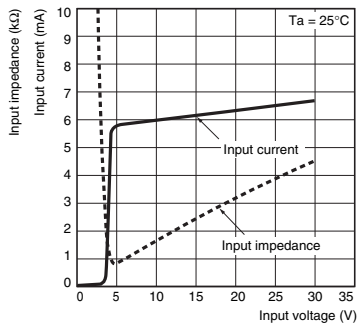

G3PE-2□□BL

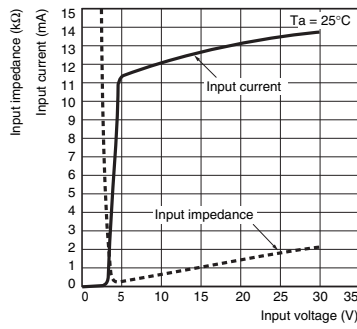

G3PE-5□□B

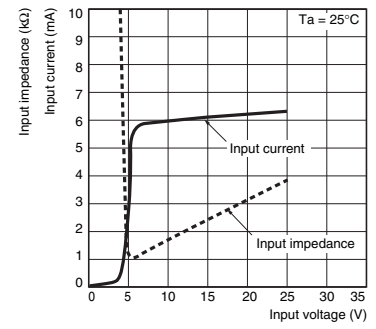

G3PE-5□□BL

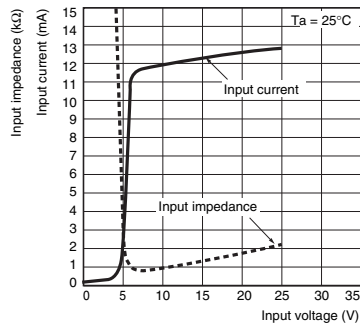

Load Current vs. Ambient Temperature

G3PE-215B(L), G3PE-225B(L)
G3PE-515B(L), G3PE-525B(L)

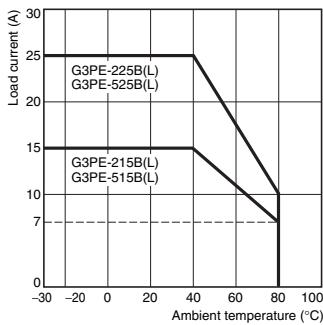

G3PE-235B(L), G3PE-245B(L)
G3PE-535B(L), G3PE-545B(L)

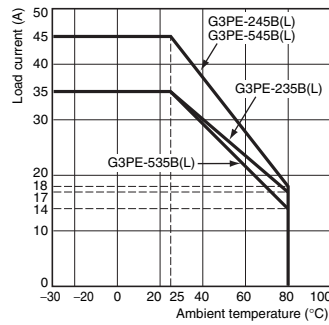

Inrush Current Resistance: Non-repetitive

Keep the inrush current to below the inrush current resistance value (i.e., below the broken line) if it occurs repetitively.

G3PE-215B(L), G3PE-515B(L)

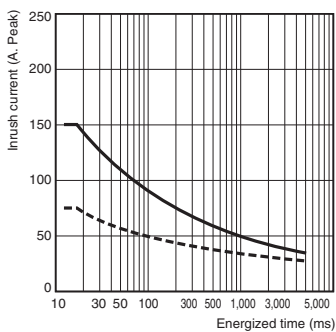

G3PE-225B(L), G3PE-525B(L)

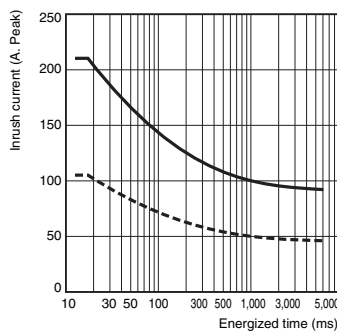

G3PE-235B(L), G3PE-245B(L)
G3PE-535B(L), G3PE-545B(L)

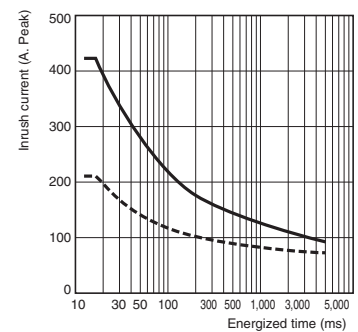

G3PE-Single-phase

Close Mounting (3 or 8 SSRs)

G3PE-215B(L)

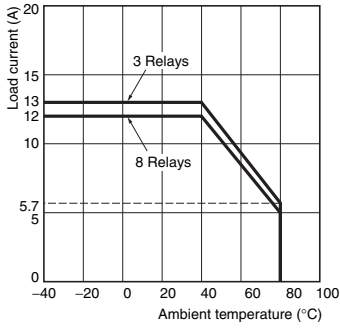

G3PE-225B(L)

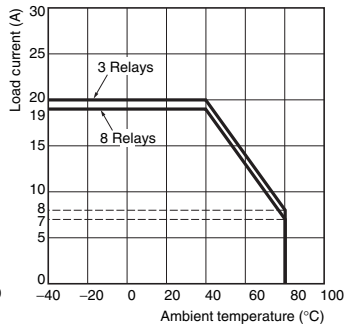

G3PE-235B(L)

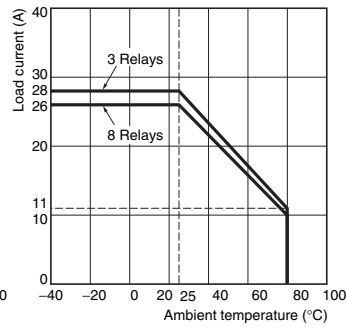

G3PE-245B(L)

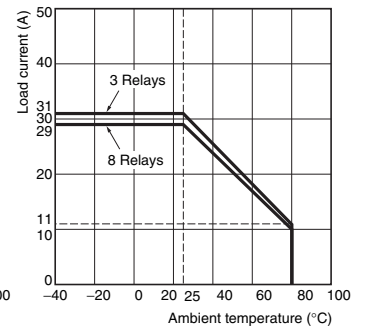

G3PE-515B(L)

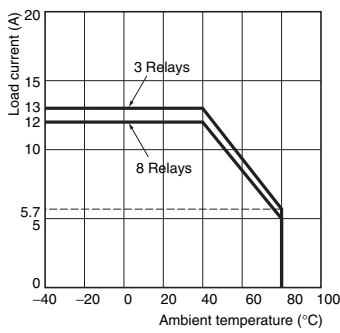

G3PE-525B(L)

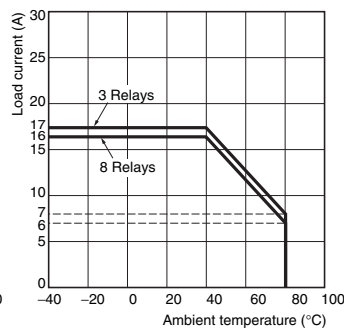

G3PE-535B(L)

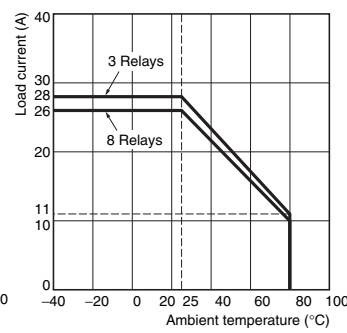

G3PE-545B(L)

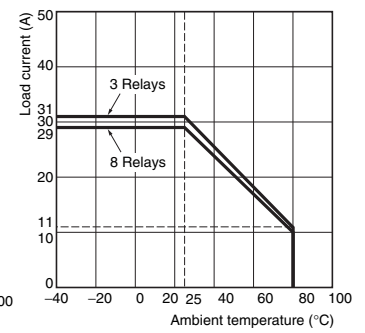

Close Mounting Example

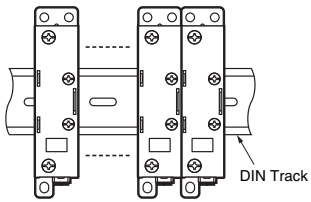

Dimensions

Note: All units are in millimeters unless otherwise indicated.

Solid State Relays

- G3PE-215B(L)
- G3PE-225B(L)
- G3PE-515B(L)
- G3PE-525B(L)

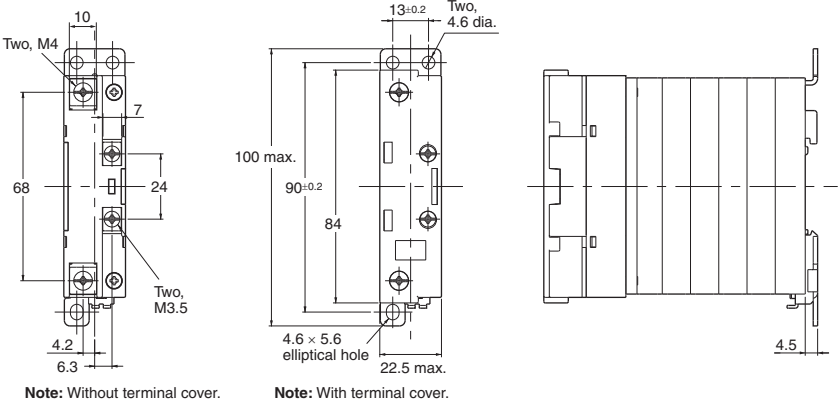

Note: Without terminal cover.

Note: With terminal cover.

Mounting Holes

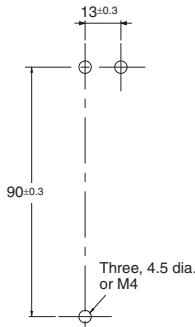

Terminal Arrangement/Internal Circuit Diagram

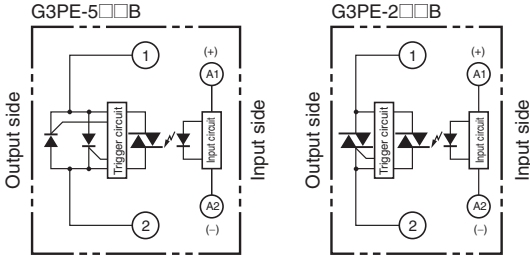

- G3PE-235B(L)
- G3PE-245B(L)
- G3PE-535B(L)
- G3PE-545B(L)

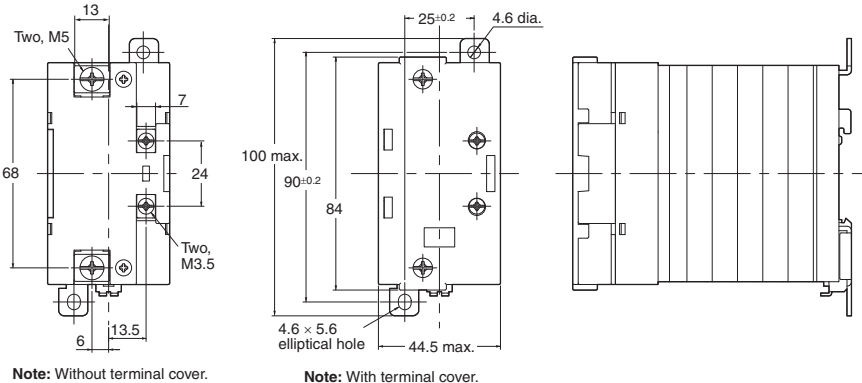

Note: Without terminal cover.

Note: With terminal cover.

Mounting Holes

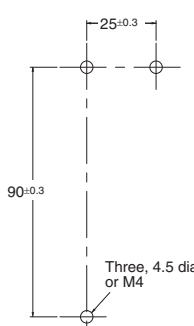

Terminal Arrangement/Internal Circuit Diagram

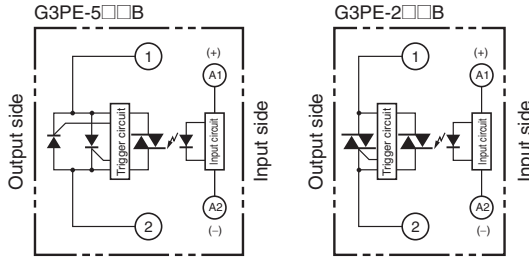

G3PE-Three-phase

**Compact, Slim-profile SSRs with Heat Sinks.
Solid State Contactors for Three-phase
Heaters Reduced Installation Work
with DIN Track Mounting.**



For the most recent information on models that have been certified for safety standards, refer to your OMRON website.

- RoHS compliant.
- Surge pass protection improved surge dielectric strength for output currents. (OMRON testing)
- Slim design with 3-phase output and built-in heat sinks.
- DIN Track mounting types and screw mounting types are available.
All DIN Track mounting types mount to DIN Track (applicable DIN Track: TR35-15Fe (IEC 60715)).
- Conforms to UL, CSA, and EN standards (TÜV certification).

Refer to *Safety Precautions* on page 18.

Ordering Information

List of Models

Models with Built-in Heat Sinks

Number of phases	Insulation method	Operation indicator	Rated input voltage	Zero cross function	Type	Applicable load *1	Number of poles	Model
Three-phase	Phototriac coupler	Yes (yellow)	12 to 24 VDC	Yes	DIN track mounting *2	15 A, 100 to 240 VAC	3	G3PE-215B-3N DC12-24
							2	G3PE-215B-2N DC12-24
						25 A, 100 to 240 VAC	3	G3PE-225B-3N DC12-24
							2	G3PE-225B-2N DC12-24
						35 A, 100 to 240 VAC	3	G3PE-235B-3N DC12-24
							2	G3PE-235B-2N DC12-24
						45 A, 100 to 240 VAC	3	G3PE-245B-3N DC12-24
							2	G3PE-245B-2N DC12-24
						15 A, 200 to 480 VAC	3	G3PE-515B-3N DC12-24
							2	G3PE-515B-2N DC12-24
						25 A, 200 to 480 VAC	3	G3PE-525B-3N DC12-24
							2	G3PE-525B-2N DC12-24
					35 A, 200 to 480 VAC	3	G3PE-535B-3N DC12-24	
						2	G3PE-535B-2N DC12-24	
					45 A, 200 to 480 VAC	3	G3PE-545B-3N DC12-24	
						2	G3PE-545B-2N DC12-24	
					Screw mounting	15 A, 100 to 240 VAC	3	G3PE-215B-3 DC12-24
							2	G3PE-215B-2 DC12-24 *3
						25 A, 100 to 240 VAC	3	G3PE-225B-3 DC12-24
							2	G3PE-225B-2 DC12-24
						35 A, 100 to 240 VAC	3	G3PE-235B-3 DC12-24
							2	G3PE-235B-2 DC12-24
						45 A, 100 to 240 VAC	3	G3PE-245B-3 DC12-24
							2	G3PE-245B-2 DC12-24
15 A, 200 to 480 VAC	3	G3PE-515B-3 DC12-24						
	2	G3PE-515B-2 DC12-24 *3						
25 A, 200 to 480 VAC	3	G3PE-525B-3 DC12-24						
	2	G3PE-525B-2 DC12-24						
35 A, 200 to 480 VAC	3	G3PE-535B-3 DC12-24						
	2	G3PE-535B-2 DC12-24						
45 A, 200 to 480 VAC	3	G3PE-545B-3 DC12-24						
	2	G3PE-545B-2 DC12-24						

*1. The applicable load current depends on the ambient temperature. For details, refer to *Load Current vs. Ambient Temperature* in *Engineering Data* on page 10.

*2. The applicable DIN Track is the TR35-15Fe (IEC 60715). For details, refer to the mounting information in the *Safety Precautions for All G3PE Models*.

*3. DIN Track or Screw mounting.

Models with Externally Attached Heat Sinks

Number of phases	Insulation method	Operation indicator	Rated input voltage	Zero cross function	Type	Applicable load *	Number of poles	Model
Three-phase	Phototriac coupler	Yes (yellow)	12 to 24 VDC	Yes	Externally attached heat sinks	15 A, 100 to 240 VAC	3	G3PE-215B-3H DC12-24
							2	G3PE-215B-2H DC12-24
						25 A, 100 to 240 VAC	3	G3PE-225B-3H DC12-24
							2	G3PE-225B-2H DC12-24
						35 A, 100 to 240 VAC	3	G3PE-235B-3H DC12-24
							2	G3PE-235B-2H DC12-24
						45 A, 100 to 240 VAC	3	G3PE-245B-3H DC12-24
							2	G3PE-245B-2H DC12-24
						15 A, 200 to 480 VAC	3	G3PE-515B-3H DC12-24
							2	G3PE-515B-2H DC12-24
						25 A, 200 to 480 VAC	3	G3PE-525B-3H DC12-24
							2	G3PE-525B-2H DC12-24
						35 A, 200 to 480 VAC	3	G3PE-535B-3H DC12-24
							2	G3PE-535B-2H DC12-24
45 A, 200 to 480 VAC	3	G3PE-545B-3H DC12-24						
	2	G3PE-545B-2H DC12-24						

* The rated load current depends on the heat sink or radiator that is mounted. It also depends on the ambient temperature. For details, refer to *Load Current vs. Ambient Temperature*.

Accessories (Order Separately)

Heat Sink

Heat resistance Rth (s-a) (°C/W)	Model
1.67	Y92B-P50
1.01	Y92B-P100
0.63	Y92B-P150
0.43	Y92B-P200
0.36	Y92B-P250

G3PE-Three-phase

Specifications

Certification

UL508, CSA22.2 No.14, and EN60947-4-3

Ratings (at an Ambient Temperature of 25°C)

Operating Circuit (All Models)

Item/Model	Same for all models
Rated operating voltage	12 to 24 VDC
Operating voltage range	9.6 to 30 VDC
Rated input current (impedance)	10 mA max. (24 VDC)
Must-operate voltage	9.6 VDC max.
Must-release voltage	1 VDC min.
Insulation method	Phototriac
Operation indicator	Yellow LED

Main Circuit of Models with Built-in Heat Sinks

Item	Model	G3PE-215B-3(N)	G3PE-215B-2(N)	G3PE-225B-3(N)	G3PE-225B-2(N)	G3PE-235B-3(N)	G3PE-235B-2(N)	G3PE-245B-3(N)	G3PE-245B-2(N)	G3PE-515B-3(N)	G3PE-515B-2(N)	G3PE-525B-3(N)	G3PE-525B-2(N)	G3PE-535B-3(N)	G3PE-535B-2(N)	G3PE-545B-3(N)	G3PE-545B-2(N)
Rated load voltage		100 to 240 VAC								200 to 480 VAC							
Operating voltage range		75 to 264 VAC								180 to 528 VAC							
Rated load current *1		15 A (at 40°C)	25 A (at 40°C)	35 A (at 25°C)	45 A (at 25°C)	15 A (at 40°C)	25 A (at 40°C)	35 A (at 25°C)	45 A (at 25°C)								
Minimum load current		0.2 A								0.5 A							
Inrush current resistance (peak value)		150 A (60 Hz, 1 cycle)	220 A (60 Hz, 1 cycle)	440 A (60 Hz, 1 cycle)				220 A (60 Hz, 1 cycle)				440 A (60 Hz, 1 cycle)					
Permissible I ² t (reference value)		121A ² s	260A ² s	1,260A ² s				260A ² s				1,260A ² s					
Applicable load (resistive load: AC1 class) *2		5.1 kW (at 200 VAC)	8.6 kW (at 200 VAC)	12.1 kW (at 200 VAC)	15.5 kW (at 200 VAC)	12.5 kW (at 480 VAC)	20.7 kW (at 480 VAC)	29.0 kW (at 480 VAC)	37.4 kW (at 480 VAC)								

*1. The applicable load current depends on the ambient temperature. For details, refer to *Load Current vs. Ambient Temperature* in *Engineering Data* on page 10.

*2. Applicable Load

Use the following formula to calculate the maximum total capacity of a heater load for a three-phase balanced load with delta connections.

Maximum load capacity = Load current × Load voltage × $\sqrt{3}$

Example: 15 A × 200 V × $\sqrt{3}$ = 5,196 W ≅ 5.1 kW

Example: 15 A × 400 V × $\sqrt{3}$ = 10,392 W ≅ 10.3 kW

Main Circuit of Models with Externally Attached Heat Sinks

Item	Model	G3PE-215B-3H	G3PE-215B-2H	G3PE-225B-3HH	G3PE-225B-2H	G3PE-235B-3H	G3PE-235B-2H	G3PE-245B-3H	G3PE-245B-2H	G3PE-515B-3H	G3PE-515B-2H	G3PE-525B-3H	G3PE-525B-2H	G3PE-535B-3H	G3PE-535B-2H	G3PE-545B-3H	G3PE-545B-2H
Rated load voltage		100 to 240 VAC								200 to 480 VAC							
Operating voltage range		75 to 264 VAC								180 to 528 VAC							
Rated load current *		15 A (at 40°C)	25 A (at 40°C)	35 A (at 25°C)	45 A (at 25°C)	15 A (at 40°C)	25 A (at 40°C)	35 A (at 25°C)	45 A (at 25°C)								
Minimum load current		0.2 A								0.5 A							
Inrush current resistance (peak value)		150 A (60 Hz, 1 cycle)	220 A (60 Hz, 1 cycle)	440 A (60 Hz, 1 cycle)				220 A (60 Hz, 1 cycle)				440 A (60 Hz, 1 cycle)					
Permissible I ² t (reference value)		121A ² s	260A ² s	1,260A ² s				260A ² s				1,260A ² s					
Applicable load (resistive load: AC1 class)		Refer to <i>Engineering Data</i> on page 10.															

* The rated load current depends on the heat sink or radiator that is mounted. It also depends on the ambient temperature. For details, refer to *Load Current vs. Ambient Temperature* in *Engineering Data* on page 10.

Characteristics

Models with Built-in Heat Sinks

Item	Model	G3PE-215B-3(N)	G3PE-215B-2(N)	G3PE-225B-3(N)	G3PE-225B-2(N)	G3PE-235B-3(N)	G3PE-235B-2(N)	G3PE-245B-3(N)	G3PE-245B-2(N)	G3PE-515B-3(N)	G3PE-515B-2(N)	G3PE-525B-3(N)	G3PE-525B-2(N)	G3PE-535B-3(N)	G3PE-535B-2(N)	G3PE-545B-3(N)	G3PE-545B-2(N)
Operate time	1/2 of load power source cycle + 1 ms max.																
Release time	1/2 of load power source cycle + 1 ms max.																
Output ON voltage drop	1.6 V (RMS) max.									1.8 V (RMS) max.							
Leakage current *	10 mA max. (at 200 VAC)									20 mA max. (at 480 VAC)							
Insulation resistance	100 MΩ min. (at 500 VDC)																
Dielectric strength	2,500 VAC, 50/60 Hz for 1 min																
Vibration resistance	<ul style="list-style-type: none"> • DIN Track mounting: 10 to 55 to 10 Hz, 0.175-mm single amplitude (0.35-mm double amplitude) • Screw mounting: 10 to 55 to 10 Hz, 0.375-mm single amplitude (0.75-mm double amplitude) 																
Shock resistance	294 m/s ² (reverse mounting: 98 m/s ²)																
Ambient storage temperature	-30 to 100°C (with no icing or condensation)																
Ambient operating temperature	-30 to 80°C (with no icing or condensation)																
Ambient operating humidity	45% to 85%																
Weight	Approx. 1.25 kg	Approx. 1.45 kg	Approx. 1.25 kg	Approx. 1.65 kg	Approx. 1.45 kg	Approx. 2.0 kg	Approx. 1.65 kg	Approx. 1.25 kg	Approx. 1.45 kg	Approx. 1.25 kg	Approx. 1.65 kg	Approx. 1.45 kg	Approx. 2.0 kg	Approx. 1.65 kg	Approx. 1.45 kg	Approx. 2.0 kg	Approx. 1.65 kg

* The leakage current of phase S will be approximately $\sqrt{3}$ times larger if the 2-element model is used.

Models with Externally Attached Heat Sinks

Item	Model	G3PE-215B-3H	G3PE-215B-2H	G3PE-225B-3H	G3PE-225B-2H	G3PE-235B-3H	G3PE-235B-2H	G3PE-245B-3H	G3PE-245B-2H	G3PE-515B-3H	G3PE-515B-2H	G3PE-525B-3H	G3PE-525B-2H	G3PE-535B-3H	G3PE-535B-2H	G3PE-545B-3H	G3PE-545B-2H
Operate time	1/2 of load power source cycle + 1 ms max.																
Release time	1/2 of load power source cycle + 1 ms max.																
Output ON voltage drop	1.6 V (RMS) max.									1.8 V (RMS) max.							
Leakage current *	10 mA max. (at 200 VAC)									20 mA max. (at 480 VAC)							
Insulation resistance	100 MΩ min. (at 500 VDC)																
Dielectric strength	2,500 VAC, 50/60 Hz for 1 min																
Vibration resistance	10 to 55 to 10 Hz, 0.375-mm single amplitude (0.75-mm double amplitude)																
Shock resistance	Destruction: 294 m/s ²																
Ambient storage temperature	-30 to 100°C (with no icing or condensation)																
Ambient operating temperature	-30 to 80°C (with no icing or condensation)																
Ambient operating humidity	45% to 85%																
Weight	Approx. 300 g																

* The leakage current of phase S will be approximately $\sqrt{3}$ times larger if the 2-element model is used.

Heat Sinks

Model	Weight
Y92B-P50	Approx. 450 g
Y92B-P100	Approx. 450 g
Y92B-P150	Approx. 600 g
Y92B-P200	Approx. 850 g
Y92B-P250	Approx. 1,200 g

G3PE-Three-phase Engineering Data

Input Voltage vs. Input Impedance and Input Voltage vs. Input Current

G3PE-2□□B-□□

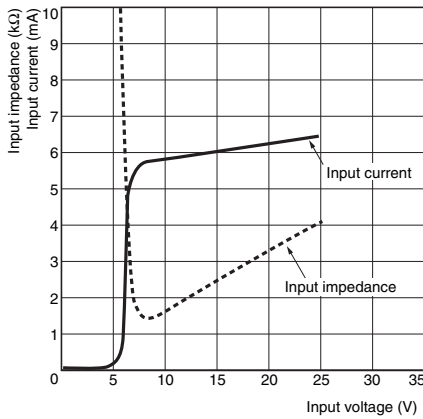

G3PE-5□□B-□□

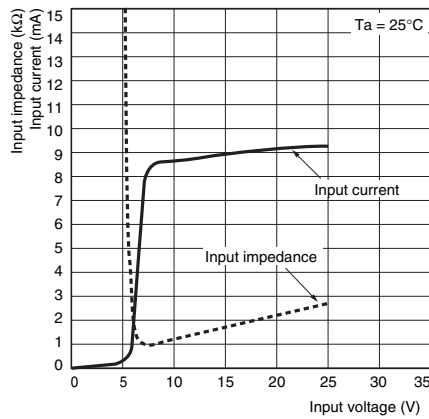

Load Current vs. Ambient Temperature

Models with Built-in Heat Sinks

G3PE-215B-3(N), G3PE-225B-3(N)

G3PE-215B-2(N), G3PE-225B-2(N)

G3PE-515B-3(N), G3PE-525B-3(N)

G3PE-515B-2(N), G3PE-525B-2(N)

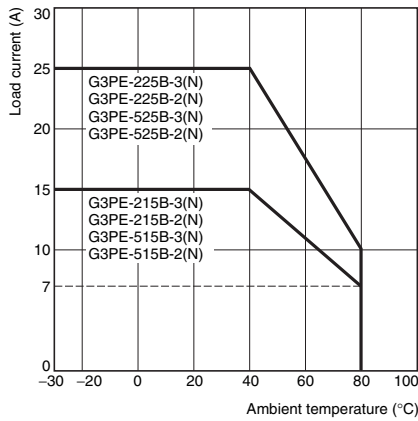

G3PE-235B-3(N), G3PE-245B-3(N)

G3PE-235B-2(N), G3PE-245B-2(N)

G3PE-535B-3(N), G3PE-545B-3(N)

G3PE-535B-2(N), G3PE-545B-2(N)

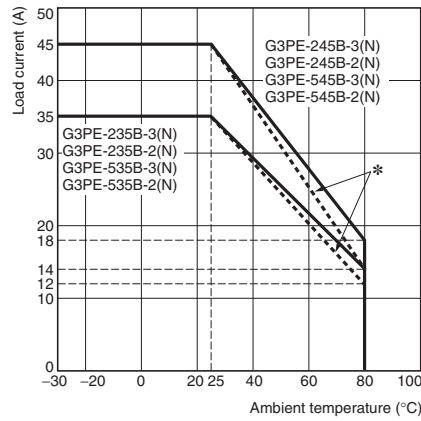

* The dotted lines in the charts are the UL derating curves for the G3PE-235B-3(N), G3PE-245B-3(N), G3PE-235B-2(N), G3PE-245B-2(N), G3PE-535B-3(N), G3PE-545B-3(N), G3PE-535B-2(N), G3PE-545B-2(N).

Models with Externally Attached Heat Sinks

G3PE-215B-3H(-2H)

G3PE-225B-3H(-2H)

G3PE-515B-3H(-2H)

G3PE-525B-3H(-2H)

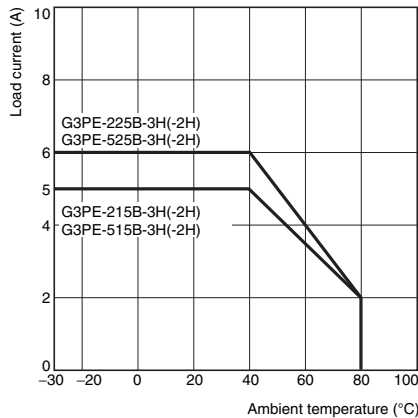

G3PE-235B-3H(-2H)

G3PE-245B-3H(-2H)

G3PE-535B-3H(-2H)

G3PE-545B-3H(-2H)

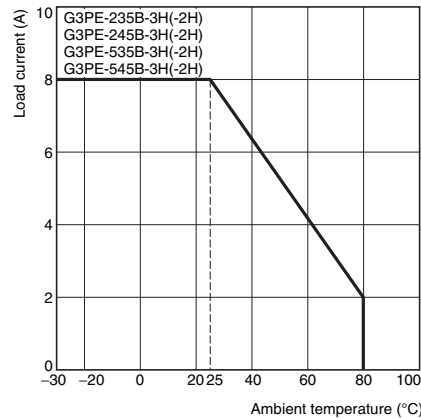

Inrush Current Resistance: Non-repetitive

Keep the inrush current to below the inrush current resistance value (i.e., below the broken line) if it occurs repetitively.

G3PE-215B-3(N)(H)
G3PE-215B-2(N)(H)

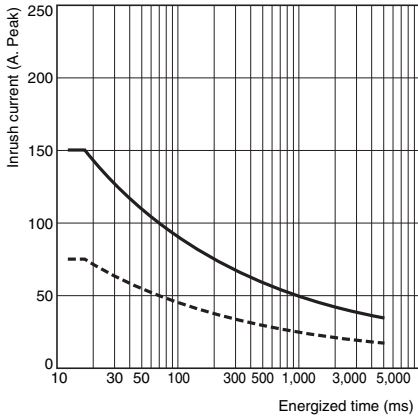

G3PE-225B-3(N)(H), G3PE-525B-3(N)(H)
G3PE-225B-2(N)(H), G3PE-525B-2(N)(H)
G3PE-515B-3(N)(H),
G3PE-515B-2(N)(H),

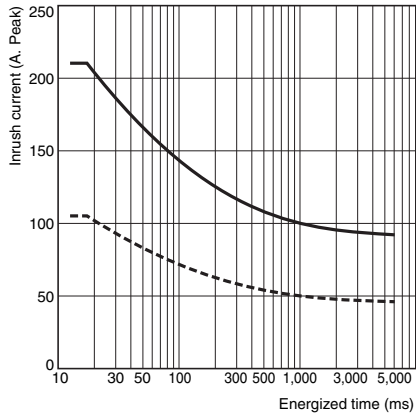

G3PE-235B-3(N)(H), G3PE-535B-3(N)(H)
G3PE-235B-2(N)(H), G3PE-535B-2(N)(H)
G3PE-245B-3(N)(H), G3PE-545B-3(N)(H)
G3PE-245B-2(N)(H), G3PE-545B-2(N)(H)

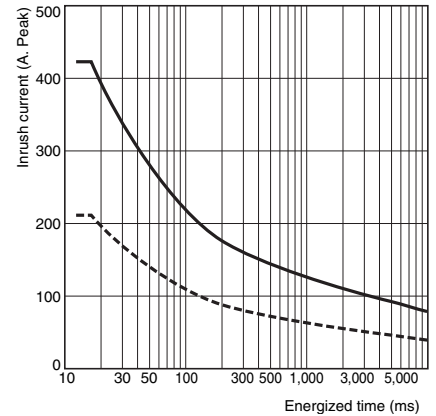

Heat Sink Area vs. Load Current (40°C and 80°C)

G3PE-225B-3H

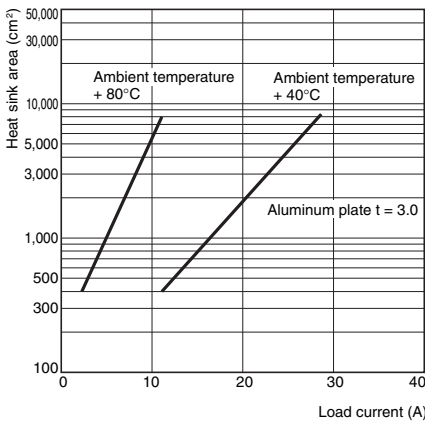

G3PE-525B-3H

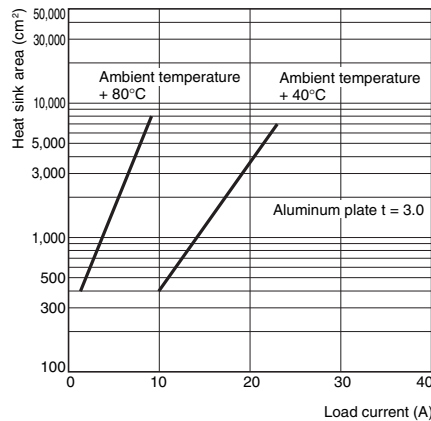

Note: The heat sink area is the combined area of all surfaces of the heat sink that radiate heat.
For the G3PE-525B-3H, when a current of 18 A flows through the SSR at 40°C, the graph shows that a heat sink area of about 2,500 cm² would be required. Therefore, if the heat sink is square, one side of an aluminum plate in the heat sink must be 36 cm or longer ($\sqrt{2,500 \text{ (cm}^2\text{)}}/2 = 36 \text{ cm}$ (rounded to a whole number)).

Models with Externally Attached Heat Sinks Heat Resistance Rth (Junction/SSR Back Surface)

Model	Rth (°C/W)
G3PE-215B-3H	1.05
G3PE-225B-3H	0.57
G3PE-235B-3H	0.57
G3PE-245B-3H	0.57

Heat Resistance of Heat Sinks

Model	Rth (°C/W)
Y92B-P50	1.67
Y92B-P100	1.01
Y92B-P150	0.63
Y92B-P200	0.43
Y92B-P250	0.36

Note: If a commercially available heat sink is used, use one that has a heat resistance equal to or lower than a standard OMRON Heat Sink.

G3PE-Three-phase

Dimensions

Note: All units are in millimeters unless otherwise indicated.

Solid State Relays

Models with DIN Track Mounting

- G3PE-215B-3N
- G3PE-215B-2N
- G3PE-225B-2N
- G3PE-515B-3N
- G3PE-515B-2N
- G3PE-525B-2N

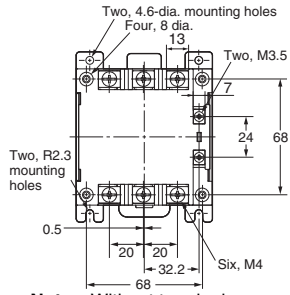

Note: Without terminal cover.

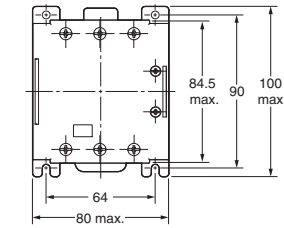

Note: With terminal cover.

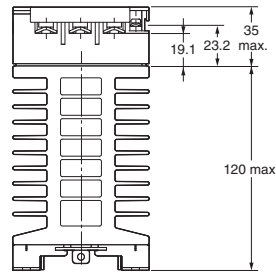
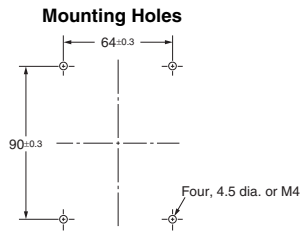
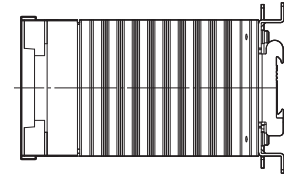

Terminal Arrangement/Internal Circuit Diagram

G3PE-215B-3N

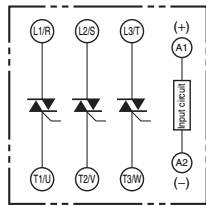

G3PE-2□5B-2N

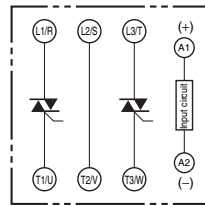

G3PE-515E-3N

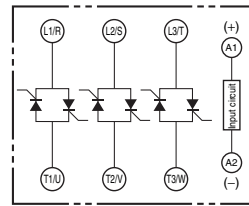

G3PE-5□5B-2N

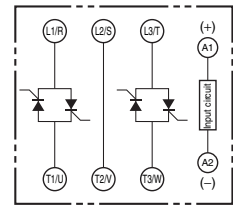

Models with DIN Track Mounting

- G3PE-225B-3N
- G3PE-235B-2N
- G3PE-525B-3N
- G3PE-535B-2N

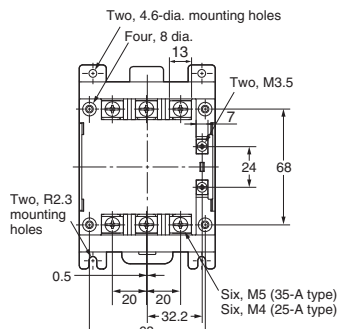

Note: Without terminal cover.

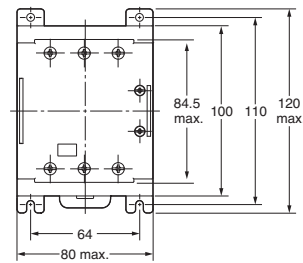

Note: With terminal cover.

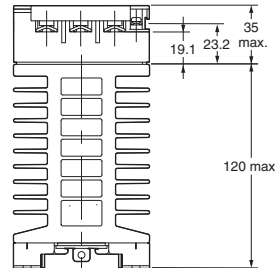
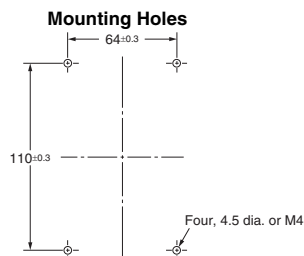
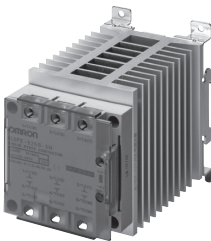
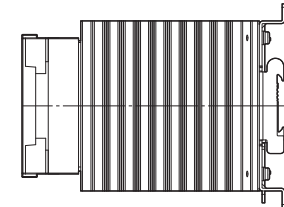

Terminal Arrangement/Internal Circuit Diagram

G3PE-225B-3N

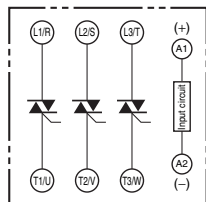

G3PE-235B-2N

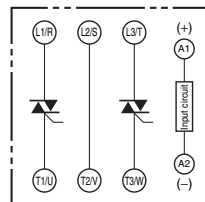

G3PE-525B-3N

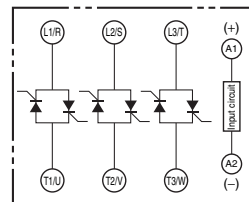

G3PE-535B-2N

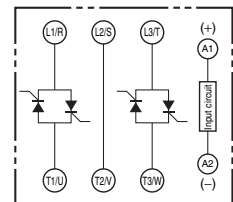

Models with DIN Track Mounting

- G3PE-235B-3N
- G3PE-245B-2N
- G3PE-535B-3N
- G3PE-545B-2N

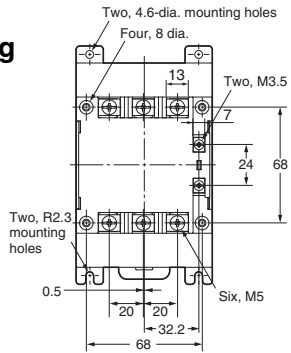

Note: Without terminal cover.

Mounting Holes

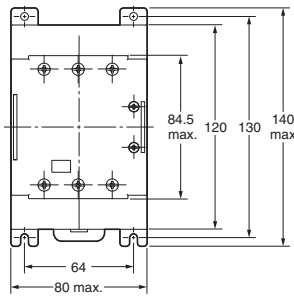
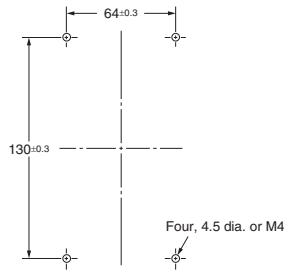

Note: With terminal cover.

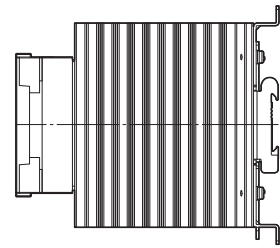
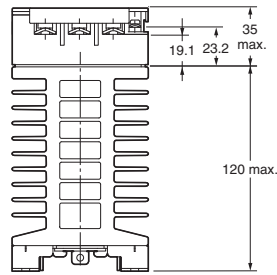

Terminal Arrangement/Internal Circuit Diagram

G3PE-235B-3N

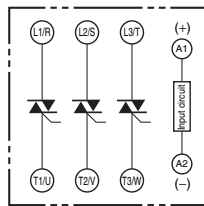

G3PE-245B-2N

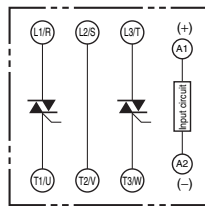

G3PE-535B-3N

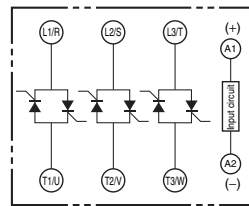

G3PE-545B-2N

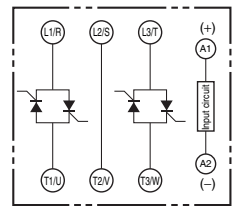

Models with DIN Track Mounting

- G3PE-245B-3N
- G3PE-545B-3N

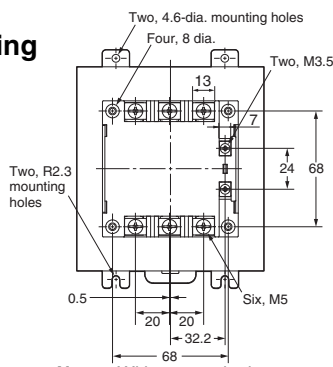

Note: Without terminal cover.

Mounting Holes

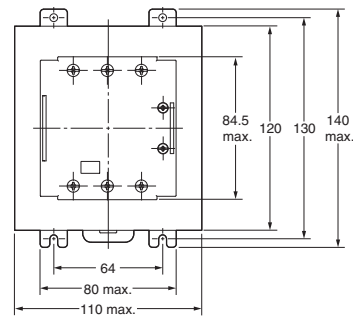
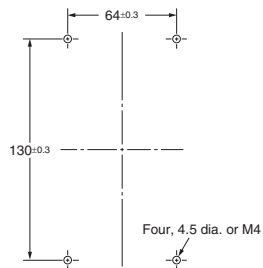

Note: With terminal cover.

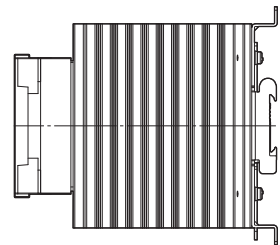
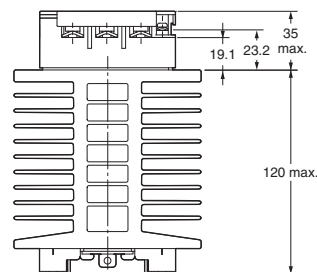

Terminal Arrangement/Internal Circuit Diagram

G3PE245B-3N

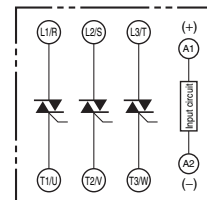

G3PE-545B-3N

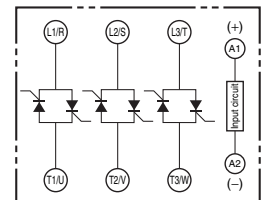

G3PE-Three-phase

Models with Screw Mounting

G3PE-215B-2
G3PE-515B-2

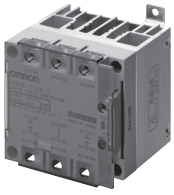

DIN Track or screw mounting

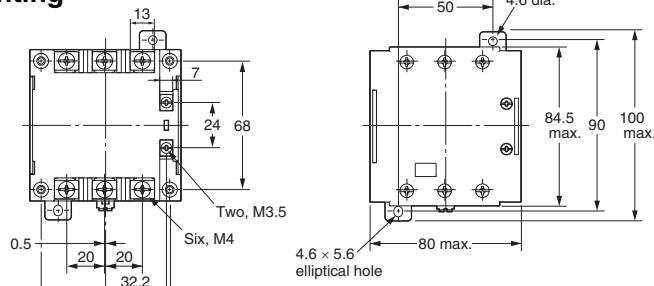

Note: Without terminal cover.

Note: With terminal cover.

Mounting Holes

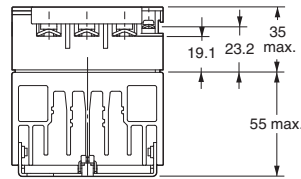
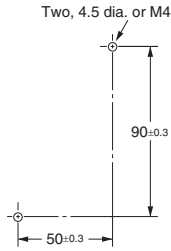

Terminal Arrangement/Internal Circuit Diagram

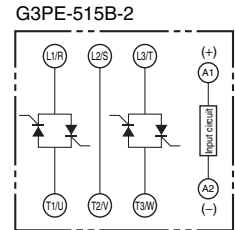
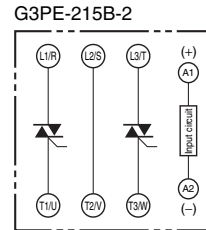

Models with Screw Mounting

G3PE-215B-3
G3PE-225B-2
G3PE-515B-3
G3PE-525B-2

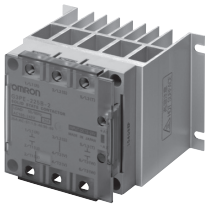

For screw mounting only

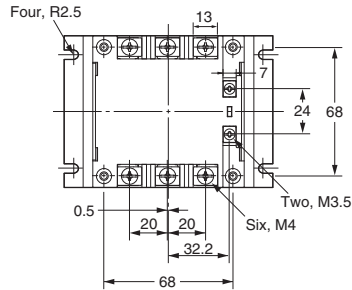

Note: Without terminal cover.

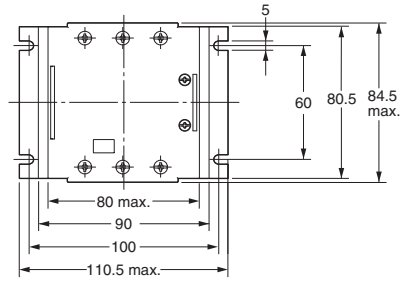

Note: With terminal cover.

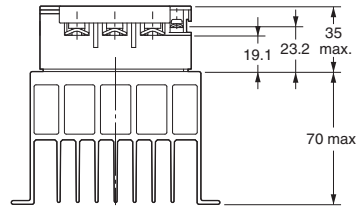
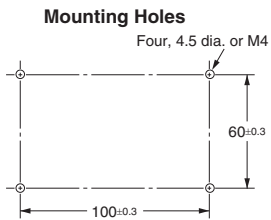

Terminal Arrangement/Internal Circuit Diagram

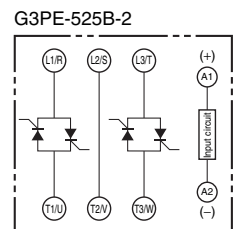
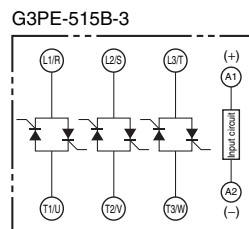
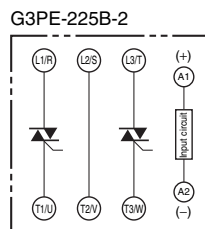
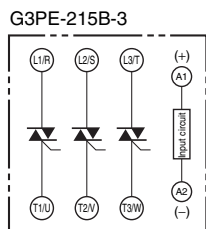

Models with Screw Mounting

G3PE-225B-3
G3PE-235B-2
G3PE-525B-3
G3PE-535B-2



For screw mounting only

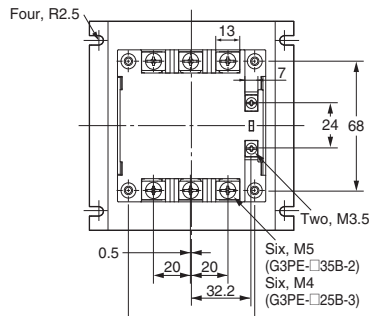

Note: Without terminal cover.

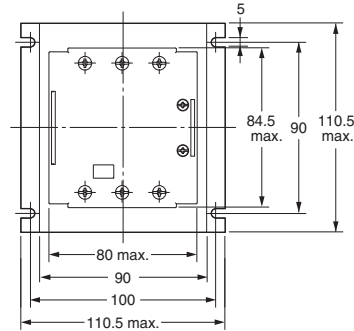

Note: With terminal cover.

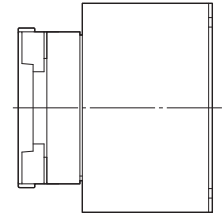

Mounting Holes

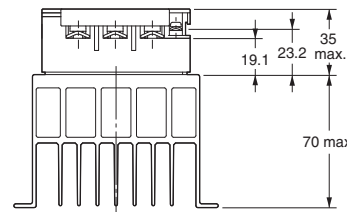
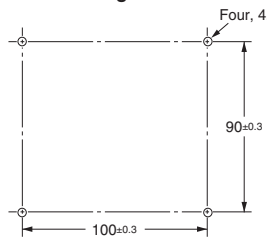

Terminal Arrangement/Internal Circuit Diagram

G3PE-225B-3

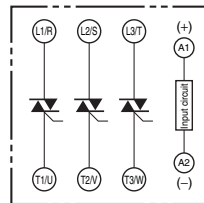

G3PE-235B-2

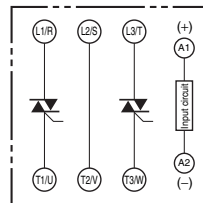

G3PE-525B-3

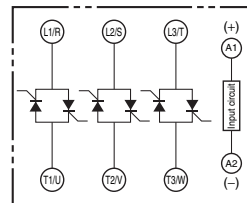

G3PE-535B-2

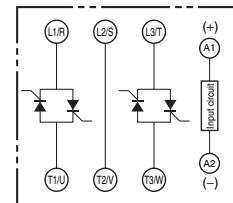

Models with Screw Mounting

G3PE-235B-3
G3PE-245B-2
G3PE-535B-3
G3PE-545B-2

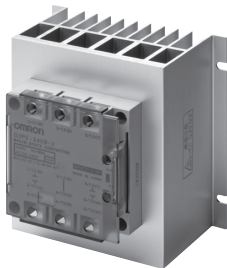

For screw mounting only

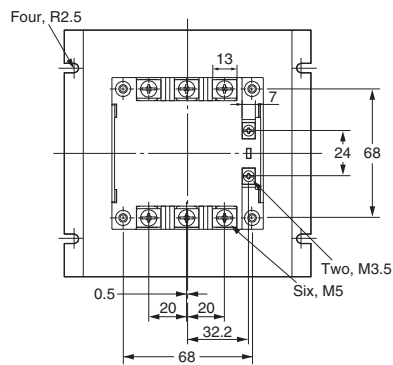

Note: Without terminal cover.

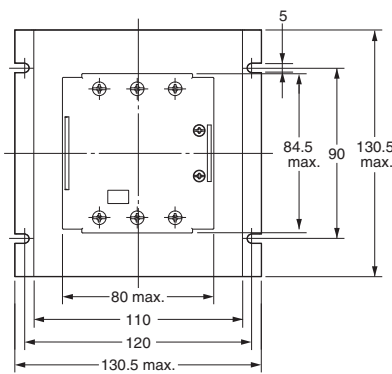

Note: With terminal cover.

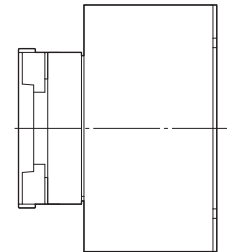

Mounting Holes

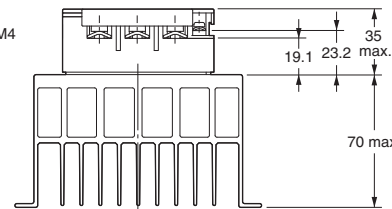
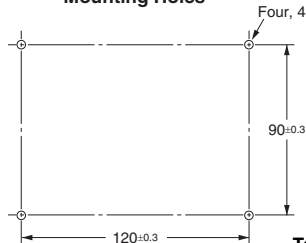

Terminal Arrangement/Internal Circuit Diagram

G3PE-235B-3

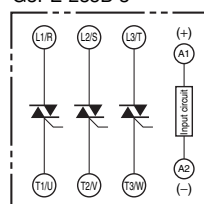

G3PE-245B-2

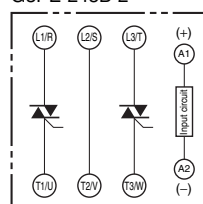

G3PE-535B-3

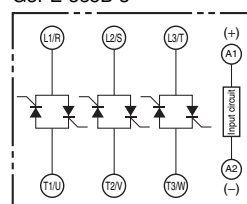

G3PE-545B-2

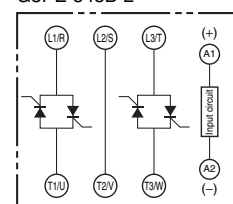

G3PE-Three-phase

Models with Screw Mounting

G3PE-245B-3
G3PE-545B-3



For screw mounting only

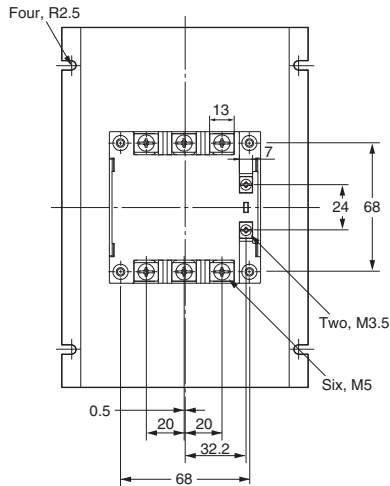

Note: Without terminal cover.

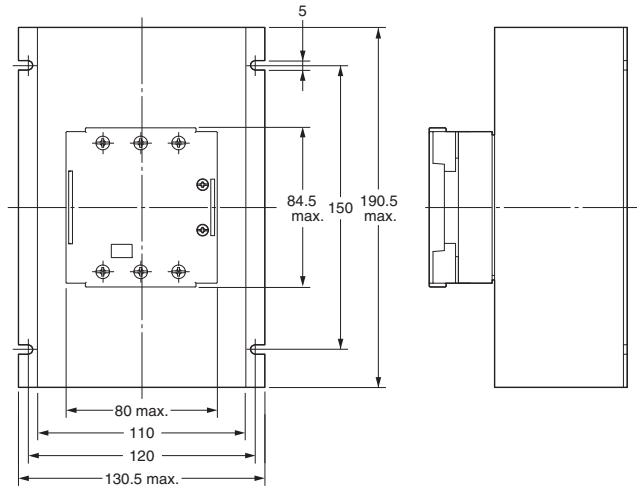

Note: With terminal cover.

Mounting Holes

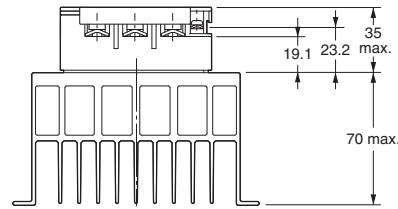
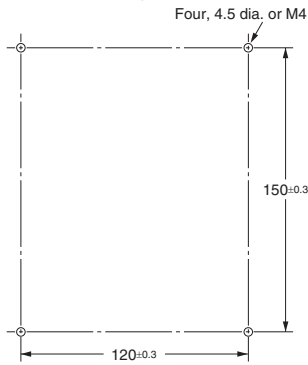

Terminal Arrangement/Internal Circuit Diagram

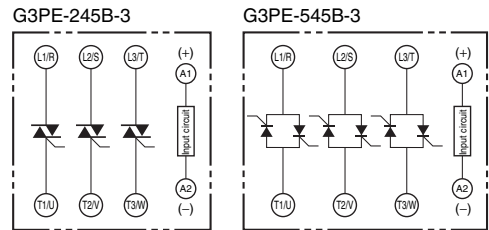

Models with Externally Attached Heat Sinks

- G3PE-215B-3H
- G3PE-215B-2H
- G3PE-225B-3H
- G3PE-225B-2H
- G3PE-235B-3H
- G3PE-235B-2H
- G3PE-245B-3H
- G3PE-245B-2H
- G3PE-515B-3H
- G3PE-515B-2H
- G3PE-525B-3H
- G3PE-525B-2H
- G3PE-535B-3H
- G3PE-535B-2H
- G3PE-545B-3H
- G3PE-545B-2H

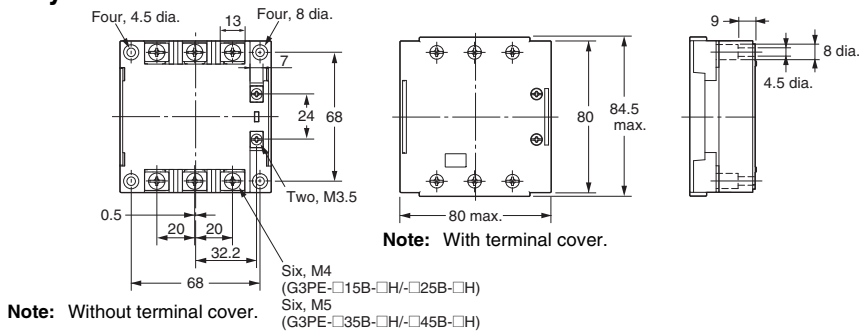

Note: With terminal cover.

Note: Without terminal cover.

Mounting Holes

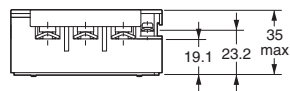
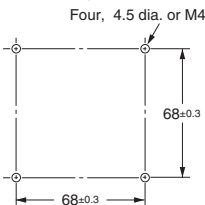

Terminal Arrangement/Internal Circuit Diagram

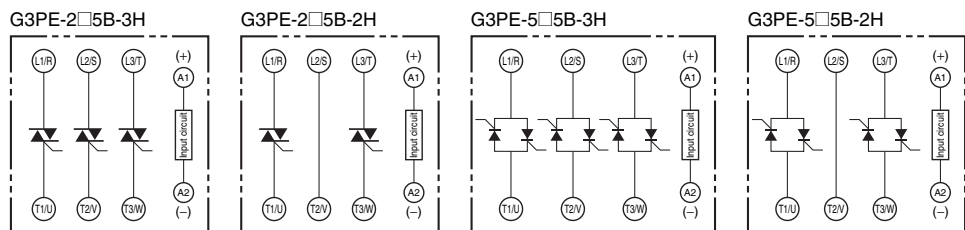

Accessories (Order Separately)

Heat Sink

Y92B-P50 (Mounts to DIN Track.)
For G3PE-215B-2H and
G3PE-515B-2H

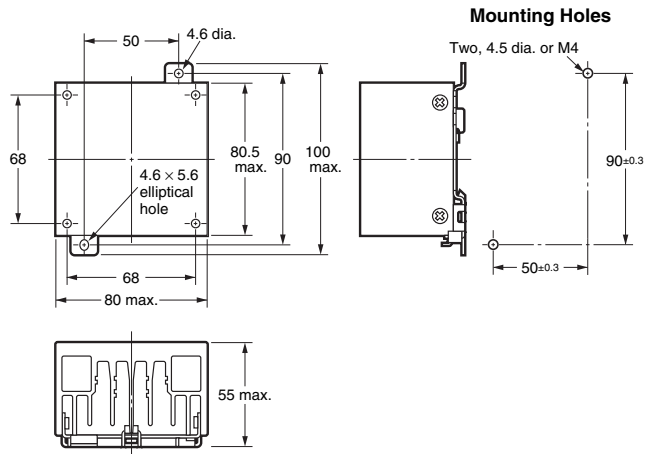

Heat Sink

Y92B-P100
For G3PE-215B-3H,
G3PE-225B-2H,
G3PE-515B-3H, and
G3PE-525B-2H

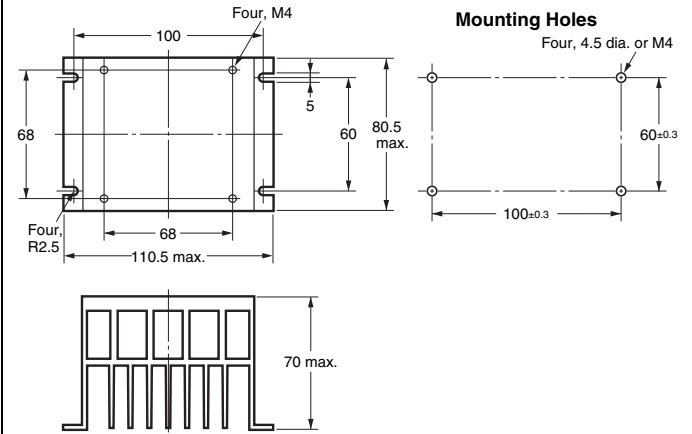

Heat Sink

Y92B-P150
For G3PE-225B-3H,
G3PE-235B-2H,
G3PE-525B-3H, and
G3PE-535B-2H

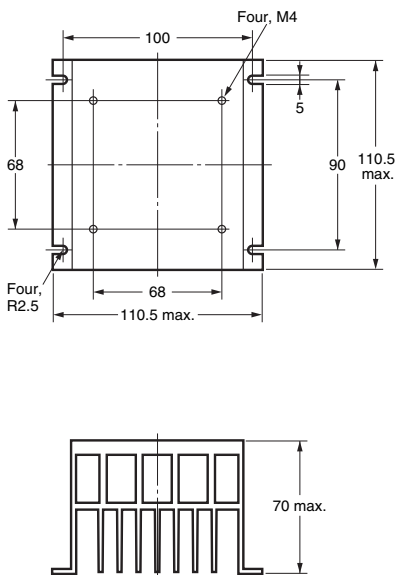

Heat Sink

Y92B-P200
For G3PE-235B-3H,
G3PE-245B-2H,
G3PE-535B-3H, and
G3PE-545B-2H

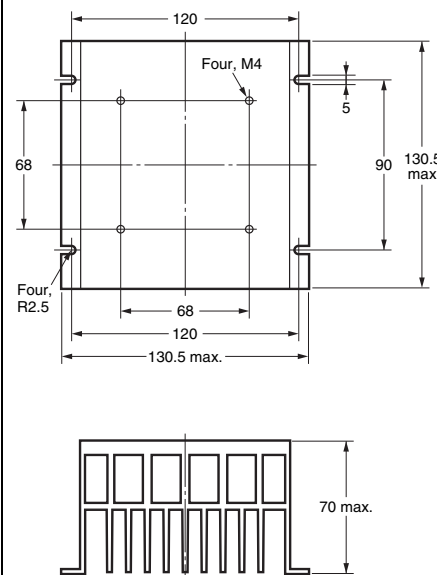

Heat Sink

Y92B-P250
For G3PE-245B-3H and
G3PE-545B-3H

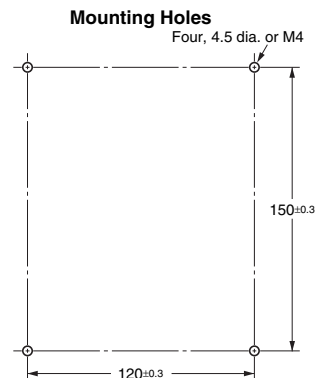
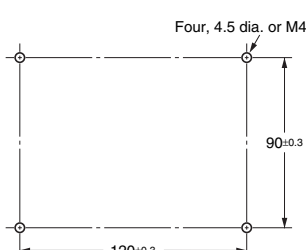
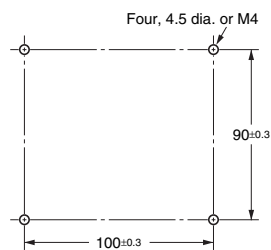
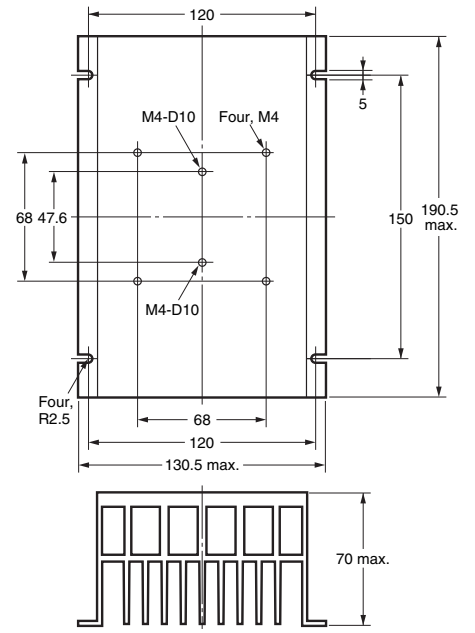

G3PE

Safety Precautions

Refer to *Safety Precautions for All Solid State Relays*.

CAUTION

Minor electrical shock may occasionally occur.
Do not touch the G3PE terminal section (i.e., current-carrying parts) while the power is being supplied.
Also, always attach the cover terminal.



The G3PE may rupture if short-circuit current flows.
As protection against accidents due to short-circuiting, be sure to install protective devices, such as fuses and no-fuse breakers, on the power supply side.



Minor electrical shock may occasionally occur.
Do not touch the main circuit terminals on the G3PE immediately after the power supply has been turned OFF. Shock may result due to the electrical charge stored in the built-in snubber circuit.



Minor burns may occasionally occur.
Do not touch the G3PE or the heat sink while the power is being supplied or immediately after the power supply has been turned OFF. The G3PE and heat sink become extremely hot.



Precautions for Safe Use

OMRON constantly strives to improve quality and reliability. SSRs, however, use semiconductors, and semiconductors may commonly malfunction or fail. In particular, it may not be possible to ensure safety if the SSRs are used outside the rated ranges. Therefore, always use the SSRs within the ratings. When using an SSR, always design the system to ensure safety and prevent human accidents, fires, and social harm in the event of SSR failure. System design must include measures such as system redundancy, measures to prevent fires from spreading, and designs to prevent malfunction.

Transport

Do not transport the G3PE under the following conditions. Doing so may result in damage, malfunction, or deterioration of performance characteristics.

- Conditions in which the G3PE may be subject to water.
- Conditions in which the G3PE may be subject to high temperature or high humidity.
- Conditions in which the G3PE is not packaged.

Operating and Storage Environments

Do not use or store the G3PE in the following locations. Doing so may result in damage, malfunction, or deterioration of performance characteristics.

- Locations subject to rainwater or water splashes.
- Locations subject to exposure to water, oil, or chemicals.
- Locations subject to high temperature or high humidity.
- Do not store in locations subject to ambient storage temperatures outside the range -30 to 100°C.
- Do not use in locations subject to relative humidity outside the range 45% to 85%.
- Locations subject to corrosive gases.
- Locations subject to dust (especially iron dust) or salts.
- Locations subject to direct sunlight.
- Locations subject to shock or vibration.

Installation and Handling

- Do not block the movement of the air surrounding the G3PE or heat sink. Abnormal heating of the G3PE may result in shorting failures of the output elements or burn damage.
- Do not use the G3PE if the heat radiation fins have been bent by being dropped. Doing so may result in malfunction due to a reduction in the heat radiation performance.
- Do not handle the G3PE with oily or dusty (especially iron dust) hands. Doing so may result in malfunction.
- Attach a heat sink or radiator when using an SSR. Not doing so may result in malfunction due to a reduction in the heat radiation performance.

Installation and Mounting

- Mount the G3PE in the specified direction. Otherwise excessive heat generated by the G3PE may cause short-circuit failures of the output elements or burn damage.
- Make sure that there is no excess ambient temperature rise due to the heat generation of the G3PE. If the G3PE is mounted inside a panel, install a fan so that the interior of the panel is fully ventilated.
- Make sure the DIN track is securely mounted. Otherwise, the G3PE may fall.
- When mounting the heat sink, do not allow any foreign matter between the heat sink and the mounting surface. Foreign matter may cause malfunction due to a reduction in the heat radiation performance.
- If the G3PE is mounted directly in a control panel, use aluminum, steel plating, or similar material with a low heat resistance as a substitute for a heat sink. Using the G3PE mounted in wood or other material with a high heat resistance may result in fire or burning due to heat generated by the G3PE.

Installation and Wiring

- Use wires that are suited to the load current. Otherwise, excessive heat generated by the wires may cause burning.
- Do not use wires with a damaged outer covering. Otherwise, it may result in electric shock or ground leakage.
- Do not wire any wiring in the same duct or conduit as power or high-tension lines. Otherwise, inductive noise may damage the G3PE or cause it to malfunction.
- When tightening terminal screws, prevent any non-conducting material from becoming caught between the screws and the tightening surface. Otherwise, excessive heat generated by the terminal may cause burning.
- Do not use the G3PE with loose terminal screws. Otherwise, excessive heat generated by the wire may cause burning.
- For the G3PE models with a carry current of 35 A or larger, use M5 crimp terminals that are an appropriate size for the diameter of the wire.
- Always turn OFF the power supply before performing wiring. Not doing so may cause electrical shock.

Installation and Usage

- Select a load within the rated values. Not doing so may result in malfunction, failure, or burning.
- Select a power supply within the rated frequencies. Not doing so may result in malfunction, failure, or burning.
- If a surge voltage is applied to the load of the Contactor, a surge bypass(*) will function to trigger the output element. The G3PE therefore cannot be used for motor loads. Doing so may result in load motor malfunction.

* Surge Bypass

This circuit protects the output circuit from being destroyed. This suppresses the surge energy applied inside the SSR in comparison with a varistor for the main circuit protection. By alleviating electrical stress on the electronic components of the SSR's output circuit, failure and destruction due to surge voltage are suppressed.

Reference value: Surge dielectric strength of 30 kV min.

(Test conditions: 1.2 × 50 μs standard voltage waveform, peak voltage of 30 kV, repeated 50 times according to JIS C5442)

Precautions for Correct Use

The SSR in operation may cause an unexpected accident. Therefore it is necessary to test the SSR under the variety of conditions that are possible. As for the characteristics of the SSR, it is necessary to consider differences in characteristics between individual SSRs.

The ratings in this catalog are tested values in a temperature range between 15°C and 30°C, a relative humidity range between 25% and 85%, and an atmospheric pressure range between 86 and 106 kPa. It will be necessary to provide the above conditions as well as the load conditions if the user wants to confirm the ratings of specific SSRs.

Causes of Failure

- Do not drop the G3PE or subject it to abnormal vibration or shock during transportation or mounting. Doing so may result in deterioration of performance, malfunction, or failure.
- Tighten each terminal to the torque specified below. Improper tightening may result in abnormal heat generation at the terminal, which may cause burning.

Terminals	Screw terminal diameter	Tightening torque
Input terminals	M3.5	0.59 to 1.18 N·m
Output terminals	M4	0.98 to 1.47 N·m
	M5	1.57 to 2.45 N·m

- Do not supply overvoltage to the input circuits or output circuits. Doing so may result in failure or burning.
- Do not use or store the G3PE in the following conditions. Doing so may result in deterioration of performance.
 - Locations subject to static electricity or noise
 - Locations subject to strong electric or magnetic fields
 - Locations subject to radioactivity

Mounting

- The G3PE is heavy. Firmly mount the DIN Track and secure both ends with End Plates for DIN Track mounting models. When mounting the G3PE directly to a panel, firmly secure it to the panel.
Screw diameter: M4
Tightening torque: 0.98 to 1.47 N·m

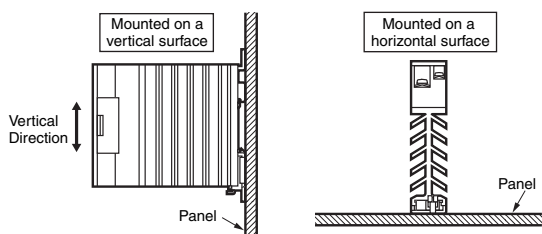

- Note:** Make sure that the load current is 50% of the rated load current when the G3PE is mounted horizontally. For details on close mounting, refer to the related information under performance characteristics. Mount the G3PE in a direction so that the markings read naturally.
- The G3PE-2N/-3N (DIN Track mounting models) can be mounted on the following TR35-15Fe (IEC 60715) DIN Tracks.

Manufacturer	Thickness	1.5 mm	2.3 mm
Schneider		AM1-DE200	---
WAGO		210-114, 210-197	210-118
PHOENIX		NS35/15	NS35/15-2.3

Wiring

- When using crimp terminals, refer to the terminal clearances shown below.

Output Terminal Section for Three-phase Models

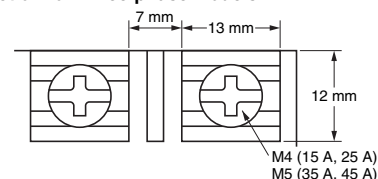

Output Terminal Section for Single-phase Models

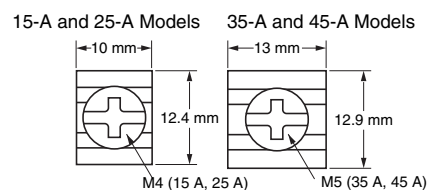

Input Terminal Section

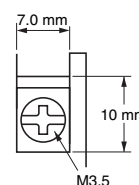

- Make sure that all lead wires are thick enough for the current.
- For three-element and two-element models, the output terminal will be charged even when the Relay is OFF. Touching the terminal may result in electric shock. To isolate the Relay from the power supply, install an appropriate circuit breaker between the power supply and the Relay. Always turn OFF the power supply before wiring the Unit.
- Terminal L2 and terminal T2 of a 2-element model are internally connected to each other. Connect terminal L2 to the ground terminal of the power supply. If terminal L2 is connected to a terminal other than the ground terminal, cover all the charged terminals, such as heater terminals, to prevent electric shock and ground faults.

Fuses

- Use a quick-burning fuse on the output terminals to prevent accidents due to short-circuiting. Use a fuse with equal or greater performance than those given in the following table.

Recommended Fuse Capacity

Rated G3PE output current	Applicable SSR	Fuse (IEC 60269-4)
15 A	G3PE□15B Series	32 A
25 A	G3PE□25B Series	
35 A	G3PE□35B Series	63 A
45 A	G3PE□45B Series	

EMC Ditective Compliance

EMC direcives can be complied with under the following conditions.

1. Single phase 240V (2□□B) models

- A capacitor must be connected to the load power supply.
- The input cable must be less than 3 m.

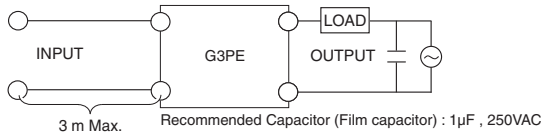

2. Single phase 480V (5□□B) models

- A capacitor must be connected to the input power supply.
- A capacitor, varistor and toroidal core must be connected to the load power supply.
- The input cable must be less than 3 m.

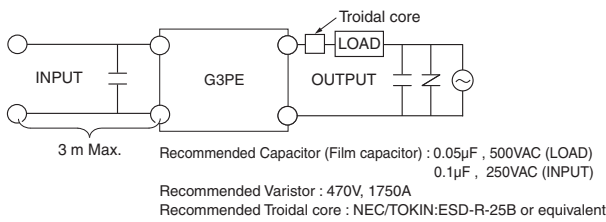

3. Three phases models

- A capacitor must be connected to the input power supply.
- A capacitor and toroidal core must be connected to the load power supply.
- The input cable must be less than 3 m.

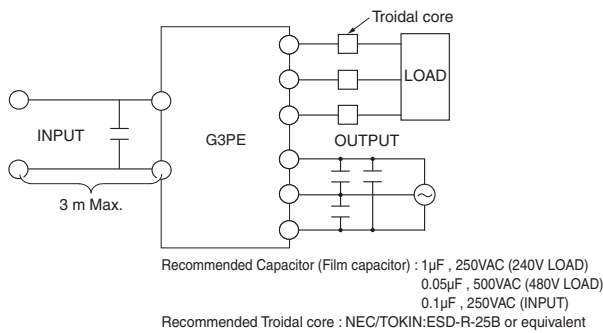

EMI

This is a Class A product (for industrial environments). In a domestic environment, the G3PE may cause radio interference, in which case the user may be required to take appropriate measures.

Noise and Surge Effects

If noise or an electrical surge occurs that exceeds the malfunction withstand limit for the G3PE output circuit, the output will turn ON for a maximum of one half cycle to absorb the noise or surge. Confirm that turning the output ON for a half cycle will not cause a problem for the device or system in which the G3PE is being used prior to actual use. The G3PE malfunction withstand limit is shown below.

- Malfunction withstand limit (reference value): 500 V

Note: This value was measured under the following conditions.

Noise duration: 100 ns and 1 µs
Repetition period: 100 Hz
Noise application time: 3 min

Mounting Models with Externally Attached Heat Sinks

- Before attaching an external Heat Sink or Radiator to the Unit, always apply silicone grease, such as Momentive Performance Material's YG6260 or Shine-Etsu Chemical's G747, to the mounting surface to enable proper heat radiation.
- Tighten the screws to the following torque to secure the Unit and external Heat Sink or Radiator to enable proper heat dissipation. Tightening torque: 2.0 N·m

Mounting to Control Panel

The G3PE is heavy. Firmly mount the DIN track and secure both ends with End Plates for DIN-track-mounting models. When mounting the G3PE directly to a panel, firmly secure it to the panel.

If the panel is airtight, heat from the SSR will build up inside, which may reduce the current carry ability of the SSR or adversely affect other electrical devices. Be sure to install ventilation holes on the top and bottom of the panel.

SSR Mounting Pitch (Panel Mounting)

- Single-phase Model

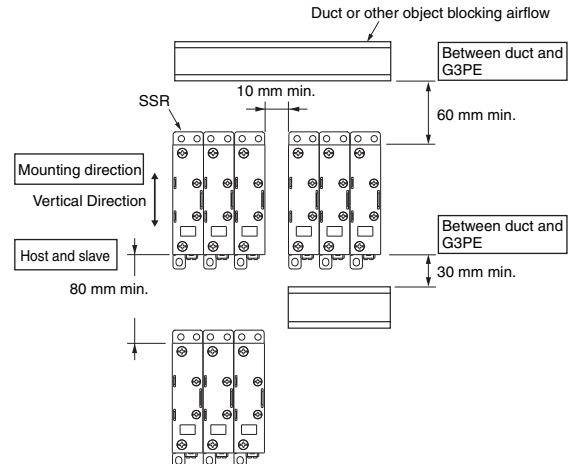

- Three-phase Models

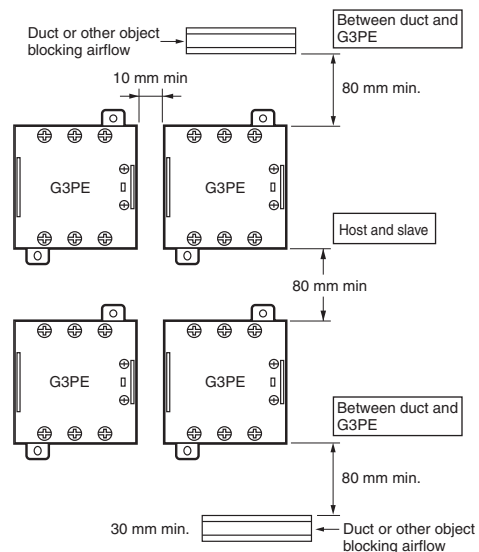

Relationship between the G3PE and Ducts or Other Objects Blocking Airflow

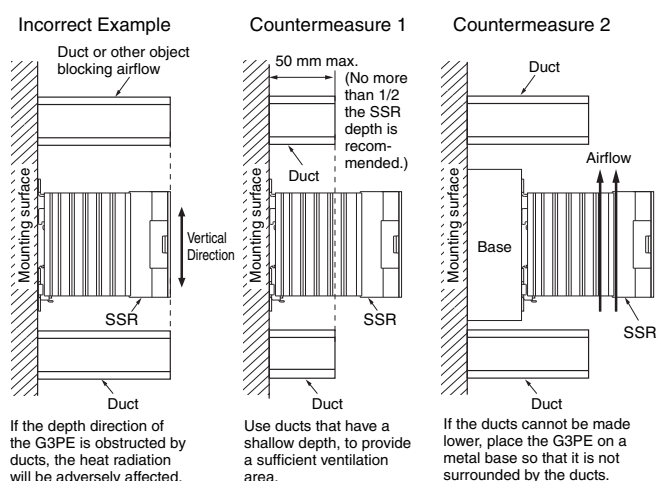

Ventilation Outside the Control Panel

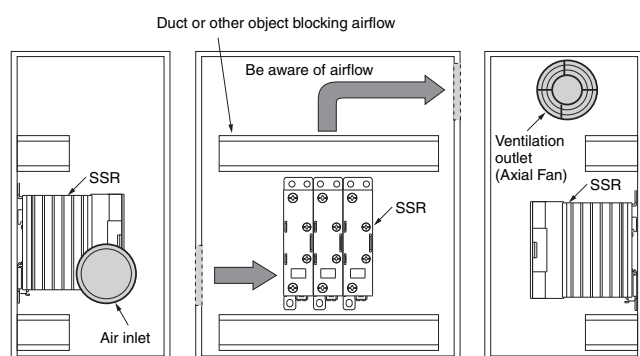

- Note:**
1. If the air inlet or air outlet has a filter, clean the filter regularly to prevent it from clogging to ensure an efficient flow of air.
 2. Do not locate any objects around the air inlet or air outlet, otherwise the objects may obstruct the proper ventilation of the control panel.
 3. A heat exchanger, if used, should be located in front of the G3PE to ensure the efficiency of the heat exchanger.

G3PE Ambient Temperature

The rated current of the G3PE is measured at an ambient temperature of 40°C.

The G3PE uses a semiconductor to switch the load. This causes the temperature inside the control panel to increase due to heating resulting from the flow of electrical current through the load. The G3PE reliability can be increased by adding a ventilation fan to the control panel to dispel this heat, thus lowering the ambient temperature of the G3PE.

(Arrhenius's law suggests that life expectancy is doubled by each 10°C reduction in ambient temperature.)

SSR rated current (A)	15 A	25 A	35 A	45 A
Required number of fans per SSR	0.23	0.39	0.54	0.70

Example: For 10 G3PE SSRs with load currents of 15 A,
 $0.23 \times 10 = 2.3$

Thus, 3 fans would be required.

- Note:**
1. Size of fans: 92 mm × 92 mm, Air volume: 0.7 m³/min, Ambient temperature of control panel: 30°C
 2. If there are other instruments that generate heat in the control panel in addition to SSRs, more ventilation will be required.
 3. Ambient temperature: The temperature that will allow the SSR to cool by convection or other means.

Terms and Conditions Agreement

Read and understand this catalog.

Please read and understand this catalog before purchasing the products. Please consult your OMRON representative if you have any questions or comments.

Warranties.

(a) Exclusive Warranty. Omron's exclusive warranty is that the Products will be free from defects in materials and workmanship for a period of twelve months from the date of sale by Omron (or such other period expressed in writing by Omron). Omron disclaims all other warranties, express or implied.

(b) Limitations. OMRON MAKES NO WARRANTY OR REPRESENTATION, EXPRESS OR IMPLIED, ABOUT NON-INFRINGEMENT, MERCHANTABILITY OR FITNESS FOR A PARTICULAR PURPOSE OF THE PRODUCTS. BUYER ACKNOWLEDGES THAT IT ALONE HAS DETERMINED THAT THE PRODUCTS WILL SUITABLY MEET THE REQUIREMENTS OF THEIR INTENDED USE.

Omron further disclaims all warranties and responsibility of any type for claims or expenses based on infringement by the Products or otherwise of any intellectual property right. (c) Buyer Remedy. Omron's sole obligation hereunder shall be, at Omron's election, to (i) replace (in the form originally shipped with Buyer responsible for labor charges for removal or replacement thereof) the non-complying Product, (ii) repair the non-complying Product, or (iii) repay or credit Buyer an amount equal to the purchase price of the non-complying Product; provided that in no event shall Omron be responsible for warranty, repair, indemnity or any other claims or expenses regarding the Products unless Omron's analysis confirms that the Products were properly handled, stored, installed and maintained and not subject to contamination, abuse, misuse or inappropriate modification. Return of any Products by Buyer must be approved in writing by Omron before shipment. Omron Companies shall not be liable for the suitability or unsuitability or the results from the use of Products in combination with any electrical or electronic components, circuits, system assemblies or any other materials or substances or environments. Any advice, recommendations or information given orally or in writing, are not to be construed as an amendment or addition to the above warranty.

See <http://www.omron.com/global/> or contact your Omron representative for published information.

Limitation on Liability; Etc.

OMRON COMPANIES SHALL NOT BE LIABLE FOR SPECIAL, INDIRECT, INCIDENTAL, OR CONSEQUENTIAL DAMAGES, LOSS OF PROFITS OR PRODUCTION OR COMMERCIAL LOSS IN ANY WAY CONNECTED WITH THE PRODUCTS, WHETHER SUCH CLAIM IS BASED IN CONTRACT, WARRANTY, NEGLIGENCE OR STRICT LIABILITY.

Further, in no event shall liability of Omron Companies exceed the individual price of the Product on which liability is asserted.

Suitability of Use.

Omron Companies shall not be responsible for conformity with any standards, codes or regulations which apply to the combination of the Product in the Buyer's application or use of the Product. At Buyer's request, Omron will provide applicable third party certification documents identifying ratings and limitations of use which apply to the Product. This information by itself is not sufficient for a complete determination of the suitability of the Product in combination with the end product, machine, system, or other application or use. Buyer shall be solely responsible for determining appropriateness of the particular Product with respect to Buyer's application, product or system. Buyer shall take application responsibility in all cases.

NEVER USE THE PRODUCT FOR AN APPLICATION INVOLVING SERIOUS RISK TO LIFE OR PROPERTY OR IN LARGE QUANTITIES WITHOUT ENSURING THAT THE SYSTEM AS A WHOLE HAS BEEN DESIGNED TO ADDRESS THE RISKS, AND THAT THE OMRON PRODUCT(S) IS PROPERLY RATED AND INSTALLED FOR THE INTENDED USE WITHIN THE OVERALL EQUIPMENT OR SYSTEM.

Programmable Products.

Omron Companies shall not be responsible for the user's programming of a programmable Product, or any consequence thereof.

Performance Data.

Data presented in Omron Company websites, catalogs and other materials is provided as a guide for the user in determining suitability and does not constitute a warranty. It may represent the result of Omron's test conditions, and the user must correlate it to actual application requirements. Actual performance is subject to the Omron's Warranty and Limitations of Liability.

Change in Specifications.

Product specifications and accessories may be changed at any time based on improvements and other reasons. It is our practice to change part numbers when published ratings or features are changed, or when significant construction changes are made. However, some specifications of the Product may be changed without any notice. When in doubt, special part numbers may be assigned to fix or establish key specifications for your application. Please consult with your Omron's representative at any time to confirm actual specifications of purchased Product.

Errors and Omissions.

Information presented by Omron Companies has been checked and is believed to be accurate; however, no responsibility is assumed for clerical, typographical or proofreading errors or omissions.

OMRON Corporation Industrial Automation Company

Tokyo, JAPAN

Contact: www.ia.omron.com

Regional Headquarters

OMRON EUROPE B.V.

Wegalaan 67-69, 2132 JD Hoofddorp
The Netherlands

Tel: (31)2356-81-300/Fax: (31)2356-81-388

OMRON ELECTRONICS LLC

2895 Greenspoint Parkway, Suite 200
Hoffman Estates, IL 60169 U.S.A

Tel: (1) 847-843-7900/Fax: (1) 847-843-7787

OMRON ASIA PACIFIC PTE. LTD.

No. 438A Alexandra Road # 05-05/08 (Lobby 2),
Alexandra Technopark,
Singapore 119967

Tel: (65) 6835-3011/Fax: (65) 6835-2711

OMRON (CHINA) CO., LTD.

Room 2211, Bank of China Tower,
200 Yin Cheng Zhong Road,
PuDong New Area, Shanghai, 200120, China

Tel: (86) 21-5037-2222/Fax: (86) 21-5037-2200

Authorized Distributor:

© OMRON Corporation 2008-2021 All Rights Reserved.
In the interest of product improvement,
specifications are subject to change without notice.

CSM_2_1
Cat. No. J174-E1-03

Printed in Japan
1021(0808)