

Product Data Sheet

GW35911

DAHLIA - Domestic range



Residential series suitable for installations on round and square boxes, characterised by an elegant appearance and classic shapes. The plates, made of technopolymer in seven colours and with different modularities, from 1 to 5-gang, can be installed in both horizontal and vertical positions. The series, developed around a core of monobloc devices, is available in two colours: white and ivory, both with a glossy finish. Expandable with ChorusSmart modular devices.

Category	Wall-mounting box	Colour	White
Material	Technopolymer	Finishing	Glossy
Description	1 gang	Torque screws tightening	0.8 Newton/meter
Glow wire test	650 °C	Thermo-pressure with ball	70 °C
Outer dim. LxHxD (mm)	89x89x40	Installation temperature	-5 +60 °C

DIMENSIONAL

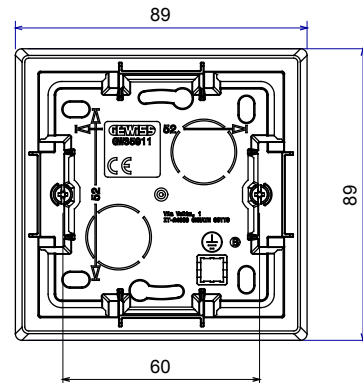
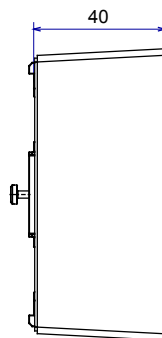
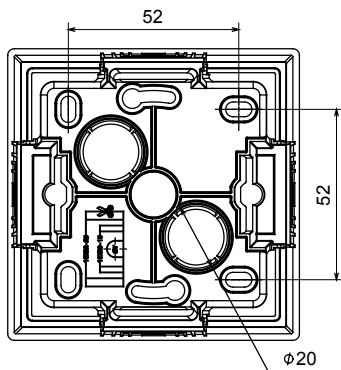

TECHNICAL SYMBOLOGY

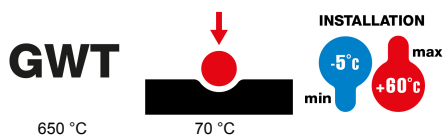

STANDARDS/APPROVALS

