

ERS 60 AS4.10 TG STTZN (407 200)

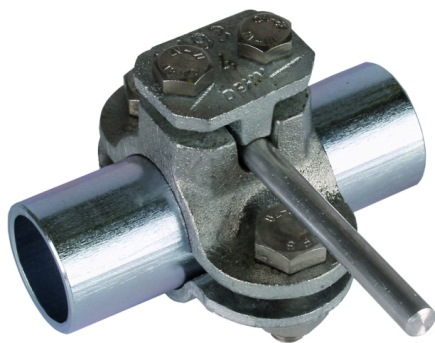
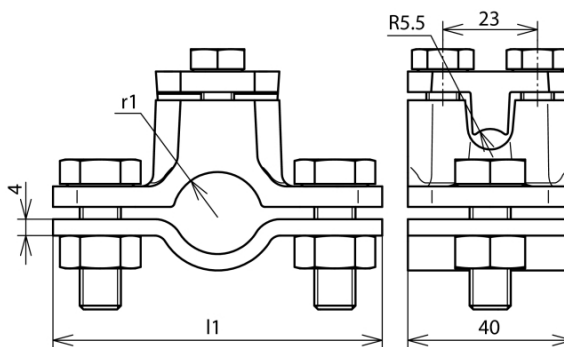

Figure without obligation



Arrangement:

Type	ERS 60 AS4.10 TG STTZN
Part No.	407 200
Clamping range pipe Ø	60 mm
Material	MCl / St/tZn
Screw	⚙️ M10 x 30 / M8 x 20 mm
Material of screw / nut	St/tZn
Dimensions (l1 x r1)	113 x 30.5 mm
Connection Rd Ø	4-10 mm
Conductor cross section	70 mm ²
Lightning current carrying capability (10/350 µs)	100 kA ^{*)}
Standard	EN 62561-1
Weight	556 g
Customs tariff number	85389099
GTIN	4013364026162
PU	1 Stk

^{*)} For exact assignment, see test certificate.

We reserve the right to introduce changes in performance, configuration and technology, dimensions, weights and materials in the course of technical progress. The figures are shown without obligation.