

Anti Collision (1) and Tandem Sensor (2) for Over-head Cranes

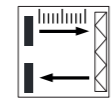
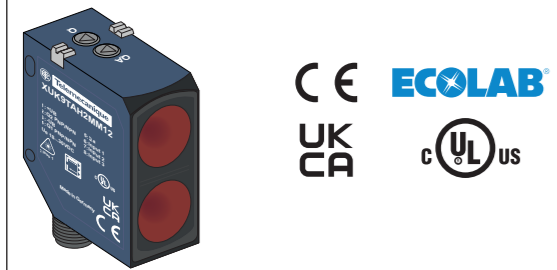

https://tesensors.com/global/en/document/EAV83775

Scan the QR-code to access this Instruction Sheet in different languages or you can download it from our website at: [www.tesensors.com](http://www.tesensors.com)

We welcome your comments about this document. You can reach us through the customer support page on your local website.

Precaution for side by side mounting

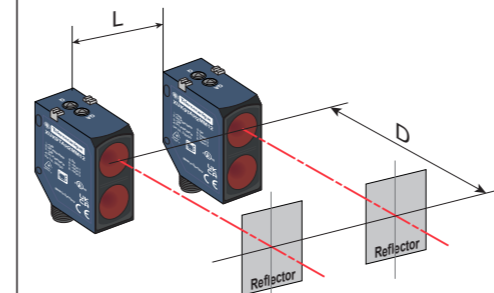

Max Qa influence (mm/in.)	L (mm/in.)				
	0	10/0.394	20/0.787	50/1.97	
D (m/ft.)	0,5/1.64	50/1.97		≤ 17/0.67	
	4/13.1	65/2.56	35/1.38		
	10/32.8	105/4.13	65/2.56		
	20/65.6	165/6.5	120/4.72	65/2.56	
	40/131.2	300/11.8	220/8.66	150/5.91	70/2.76
70/230	490/19.3	390/15.4	295/11.6	235/9.25	

Characteristics

Certification	CE - UKCA - cULus - Ecolab
Sensing distance (Reference material)	0,3...70 m / 0.98...230 ft
Setting	Teach button or remote teach-in
Color of detection light beam	Laser class 1, red, 660 nm
Spot size of the light beam	see "Light beam size" curve
Wavelength	λ = 660 nm
Puls duration	t ≤ 8 ns
Frequency	f = 33 kHz
Limit of radiant power pulse	Pp < 310 mW
Switching output	PNP or NPN
Analog output (Teachable only via button on the device)	4...20 mA
Current consumption	≤ 60 mA
Switching capacity	≤ 100 mA
Switching frequency	≤ 1500 Hz
First-up delay	300 ms max.
Response time	10 ms max.
Recovery time	10 ms max.
Ambient Temperature	Operating : - 30...+50 °C (-22...+122 °F) Storage : - 30...+60 °C (-22...+140 °F)
Power Voltage	Rated operational voltage: 24 Vdc Ripple p-p 10% maximum Operating range: 18...30 Vdc (including ripple)
Product Protection	Power supply : Reverse polarity protection Output: Short circuit protection
Protection class	IP67
Degree of protection	IP67 conforming to EN/IEC 60529 IP69K conforming to DIN 40050
Vibration resistance	Frequency range: 10 Hz to 55 Hz Acceleration: 7 gn
Shock resistance	Peak acceleration: 10 gn Duration of the pulse: 11 ms
Material	Housing: ABS/PC, Lens: PMMA

Tightening torques

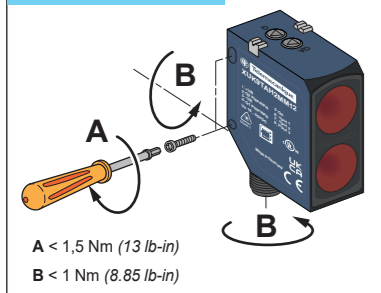

LEDs and Setting

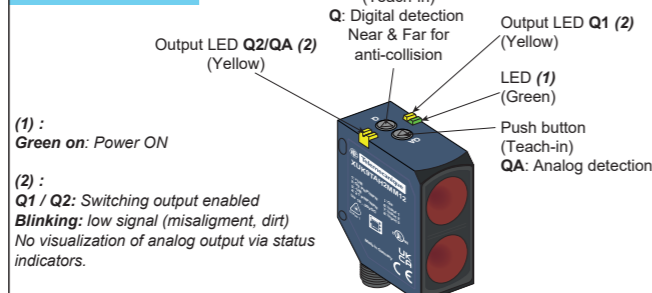

Dimensions

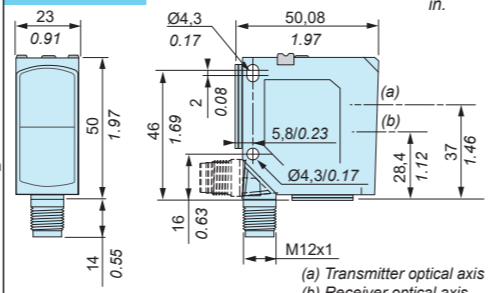

Wiring diagrams

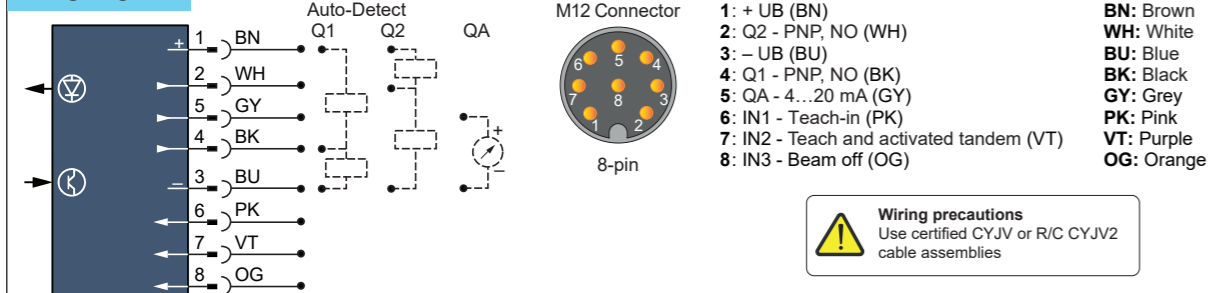

Reflector alignment

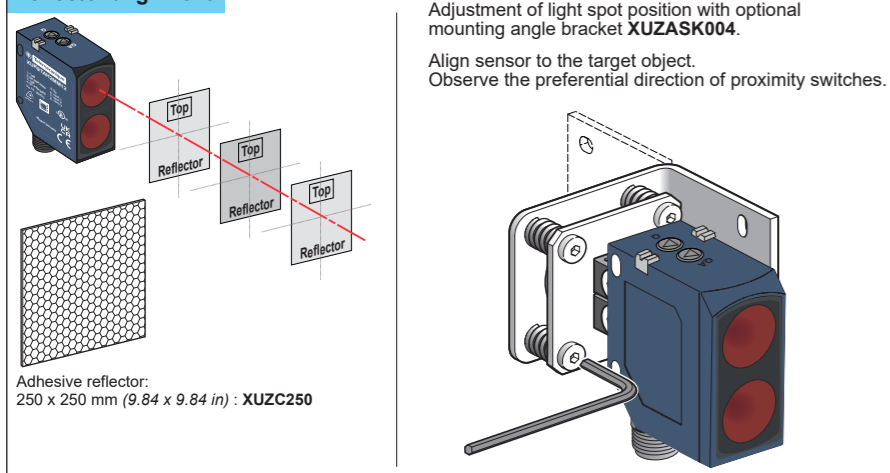

Detection curves

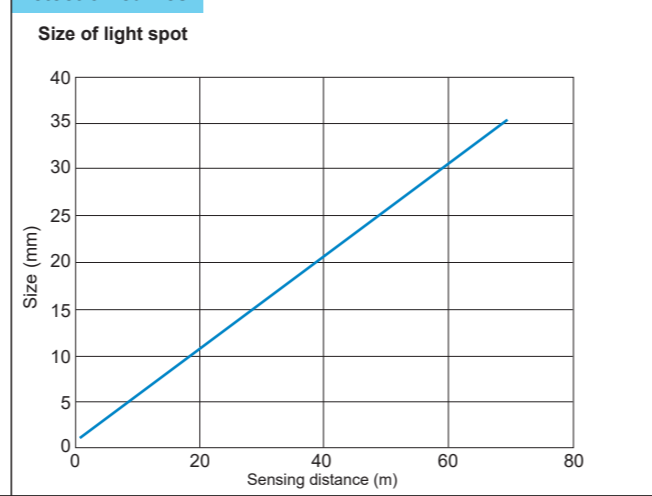

**WARNING**

UNINTENDED EQUIPMENT OPERATION

- Comply with the wiring and configuration instructions.
- Clean the lens regularly, taking care not to scratch it.
- Check the connections and fixings during maintenance operations.

Failure to follow these instructions can result in death, serious injury or equipment damage.

**CAUTION**

HAZARD OF LASER RADIATION EXPOSURE

- Do not stare into the beam.
- Do not operate below - 30°C (- 22°F)
- Follow all operating instructions.

Failure to follow these instructions can result in injury or equipment damage.

CLASS 1 LASER PRODUCT (IEC 60825-1: 2014)  
Complies with 21 CFR 1040.10 and 1040.11 except for deviations pursuant to Laser Notice No. 56 dated May, 2019

Electrical equipment should be installed, operated, serviced and maintained only by qualified personnel.  
No responsibility is assumed by Schneider Electric for any consequences arising out of the use of this material.  
© 2022 Schneider Electric. "All Rights Reserved."

**Manufacturer :**  
Schneider Electric Industries SAS  
35 rue Joseph Monier  
92500 Rueil Malmaison  
France

**UK Representative :**  
Schneider Electric Limited  
Stafford Park 5  
Telford, TF3 3BL  
United Kingdom

**Уполномоченный поставщик в РФ :**  
АО «Шнейдер Электрик»  
Адрес: 127018, Россия, г. Москва, ул. Двинцев, д.12, корп.1  
Тел. +7 (495) 777 99 90  
Факс +7 (495) 777 99 92

**Қазақстан Республикасында ресми жеткізуші :**  
ЖШС «Шнейдер Электрик»  
Мекен-жайы: Қазақстан Республикасы, Алматы қ., Достық даң., «Кен Дала» Бизнес Орталығы, 5-ші қабат.  
Тел.: +7 (727) 357 23 57  
Факс.: +7(727) 357 24 39

**Setting for Anti-collision mode**

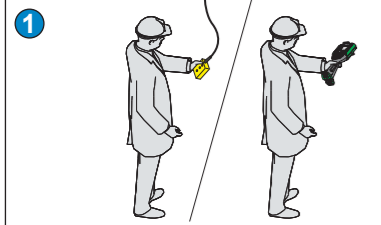
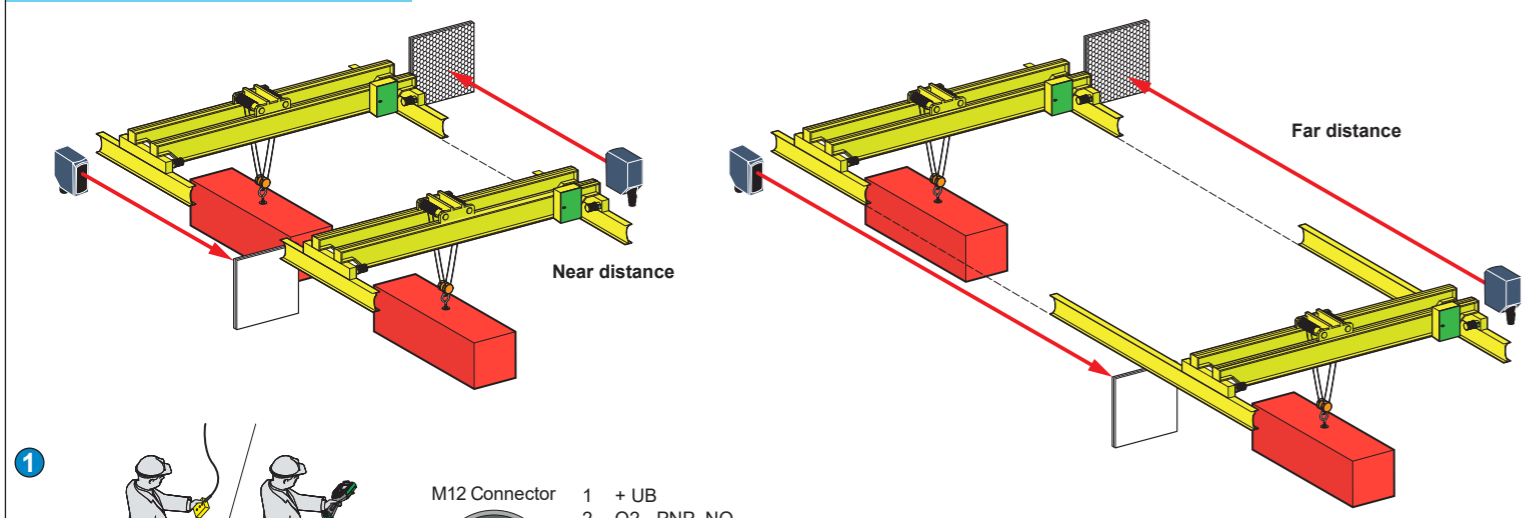

M12 Connector 8-pin

1	+ UB
2	Q2 - PNP, NO
3	GND
4	Q1 - PNP, NO
5	QA - 4...20 mA
6	IN1 - Teach-in
7	IN2 - Teach and activated tandem
8	IN3 - Beam off

**Setting**

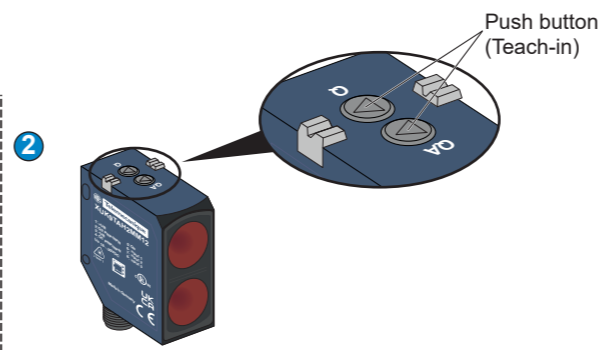
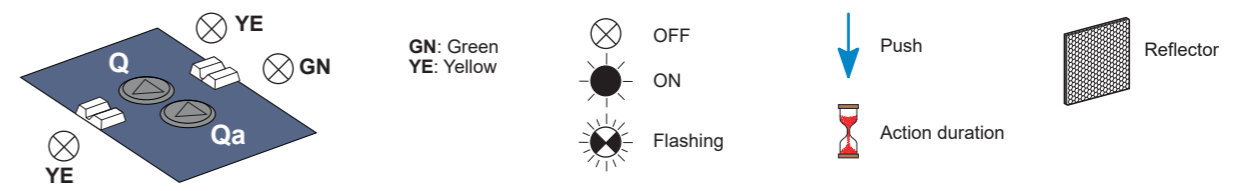

**Teach-in Anti-Collision Mode through external wire**

**1.Step:** First position  
IN 1 = High > 3 sec and deactivation

**2.Step:** Second position  
IN 1 = High > 32 ms and deactivation

The nearest of the two positions is taken as NEAR, the other is taken as FAR.  
Set points NEAR and FAR are stored permanently even if you return from "Tandem Mode" in "Anti-Collision Mode".  
Teach-in of the distance is done at the falling edge of the signal.  
To set new distances for NEAR and FAR, a new complete teach-in needs to be done.  
During teach, Q1 and Q2 are in slow mode condition (Q1=1, Q2=0)  
If NEAR and FAR are too close together: previous setting is kept.  
Time out to go back to operation mode between 1st step and 2nd step should be 30 minutes.

**Teach-in Anti-Collision Mode by Push button**

**1.Step:** First position  
Press button Q for > 3 sec and release.  
Feedback of status indicators.

**2.Step:** Second position  
Press button Q and release  
Feedback of status indicators

The nearest of the two positions is taken as NEAR, the other is taken as FAR.  
Set points NEAR and FAR are stored permanently even if you return from "Tandem Mode" in "Anti-Collision Mode".  
Teach-in of the distance is done when releasing the teach-in button.  
During teach, Q1 and Q2 are in slow mode condition (Q1=1, Q2=0)  
Time out to go back to operation mode between 1st step and 2nd step should be 5 minutes.  
If NEAR and FAR are too close together: previous setting is kept.  
No feedback via wire.

**Feedback of teach-in and wire brake check**

**If low signal function is activated**  
Response to check wires not cut and teach is completed via external wire:  
Q1 = Q2 = 3 pulses 100 ms high / 100 ms low (600 ms)



**Feedback NEAR and FAR are too close:**  
Q1 = Q2 = 6 pulses 100 ms high / 100 ms low.



**If low signal function is disabled**  
No feed back on Q1 and Q2.

**Feedback of teach-in via button**

- Teach Feedback:**
- Feedback teach success: Synchronous blinking of LEDs for 3 s.
  - Feedback NEAR and FAR are too close together: Fast asynchronous blinking of LEDs for 3 s.

**Output during anti-collision mode**

Q1 = High / Q2 = High → High speed  
Q1 = High / Q2 = Low → Slow  
Q1 = Low / Q2 = Low → Stop

**If low signal function is activated**  
Q1 = Low / Q2 = High → to less signal, reflector outside range or no reflector signal (\*).

**If low signal function is disabled**  
Q1 = high / Q2 = High → to less signal, reflector outside range or no reflector signal.

(\* See Chapter B (page 3).

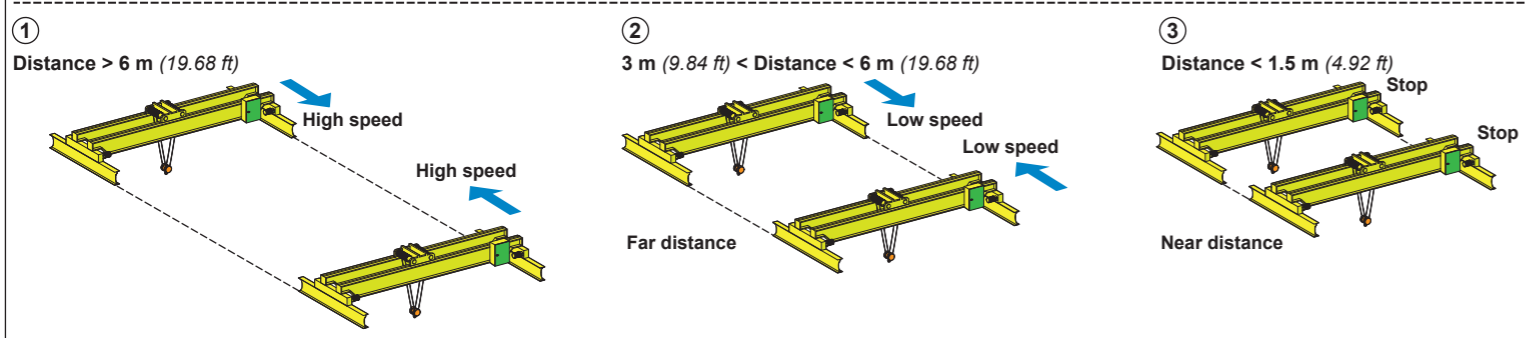

- 1 If the distance between cranes is big enough, the speed of each crane can be **high** ( 20 ...60 m/min).
- 2 If the distance is reduced ( 3 .. 6 m), the speed of each crane must be limited to **low** ( 5 ... 15 m/min).
- 3 If the distance is really too short ( 1 ... 1,5 m), then risk of collision so the 2 cranes must be **stopped**.

**Anti-Collision Diagram**

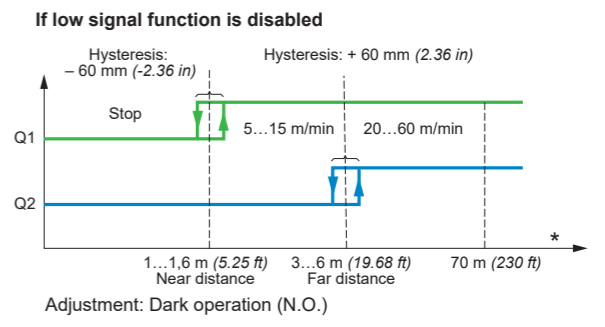
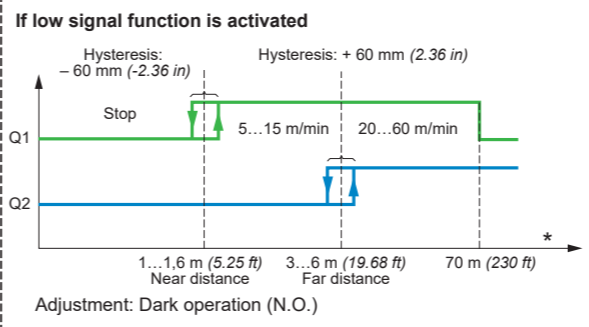

Setting for Tandem mode

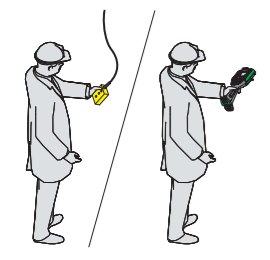
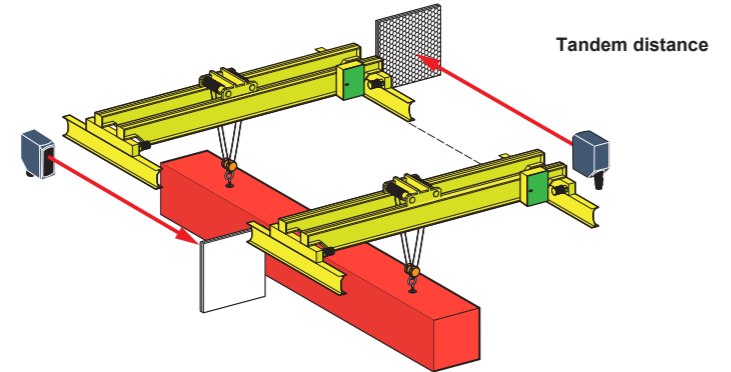

M12 Connector 8-pin

1	+ UB
2	Q2 - PNP, NO
3	GND
4	Q1 - PNP, NO
5	QA - 4...20 mA
6	IN1 - Teach-in
7	IN2 - Teach and activated tandem
8	IN3 - Beam off

Teach-in and activation of tandem mode through external wire

IN 2 = High  
 The sensor teaches the distance of the tandem when activating IN 2 for at least 32 ms.  
 The sensor puts a window around the taught-in distance.  
 After deactivating IN 2 for at least 32 ms, the sensor goes back to anti-collision mode.  
 The distance of the tandem mode is not stored permanently.

Feedback of teach-in and wire brake check

**If low signal function activated**  
 Response that tandem mode is activated and to check that wires are not cut:  
 • If tandem teach is **successful**  
 Q1 = Q2 = permanent pulses 100 ms high / 100 ms low (600 ms)  
 • If tandem teach is **not successful** (e.g no reflector present)  
 Q1 = Q2 = 6 pulses 100 ms high / 100 ms low (1200 ms)  
 If IN2 is deactivated during feedback, the feedback is stopped immediately.  
**If low signal function is disabled**  
 No feed back on Q1 and Q2 for successful teach and not successful teach.

Tandem Mode

Q1 = Low / Q2 = Low → Outside window and closer than window closest position of the window.  
 Q1 = High / Q2 = High → Inside the window  
 Q1 = High / Q2 = Low → outside the window and farther than the farthest position of the window.

**If low signal function (\*) is activated**  
 Q1 = Low / Q2 = High → outside range → to less signal, reflector outside range.  
**If low signal function (\*) is disabled**  
 Q1 = Low / Q2 = Low → outside range → to less signal, reflector outside range.

(\*) This state can be disabled by pressing Q button for > 16 s See ①.

Tandem Diagram

If low signal function is activated

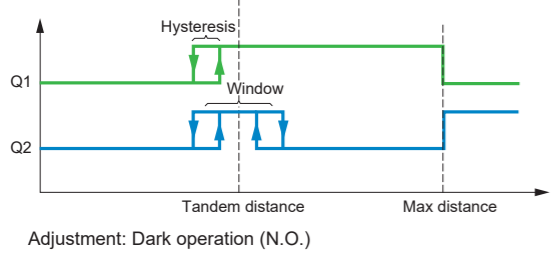

If low signal function is disabled

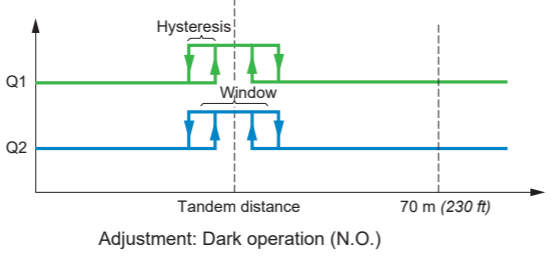

Setting

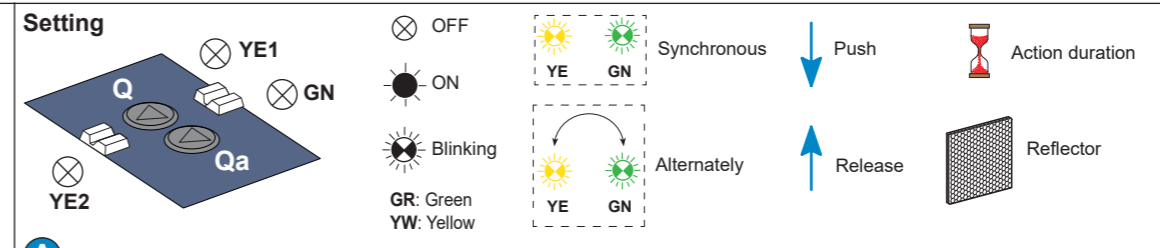

A Analog Output

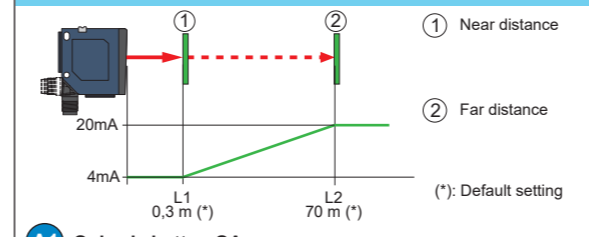

A1 Only via button QA

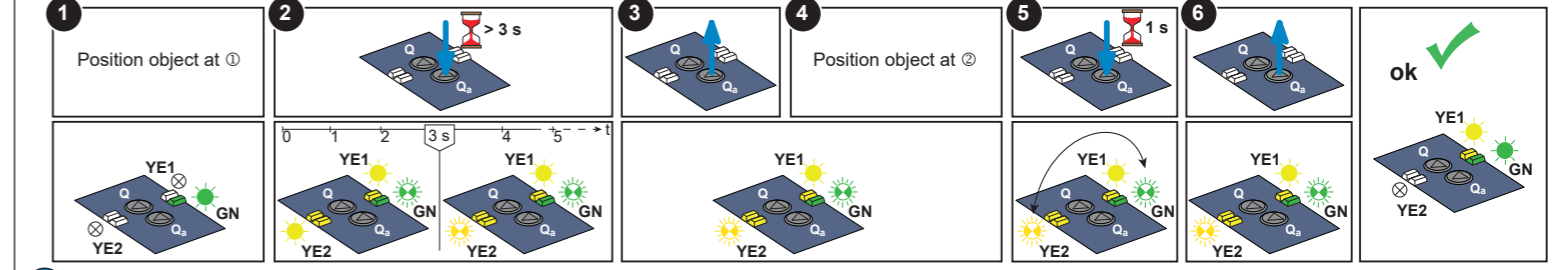

A2 Only via remote input IN1

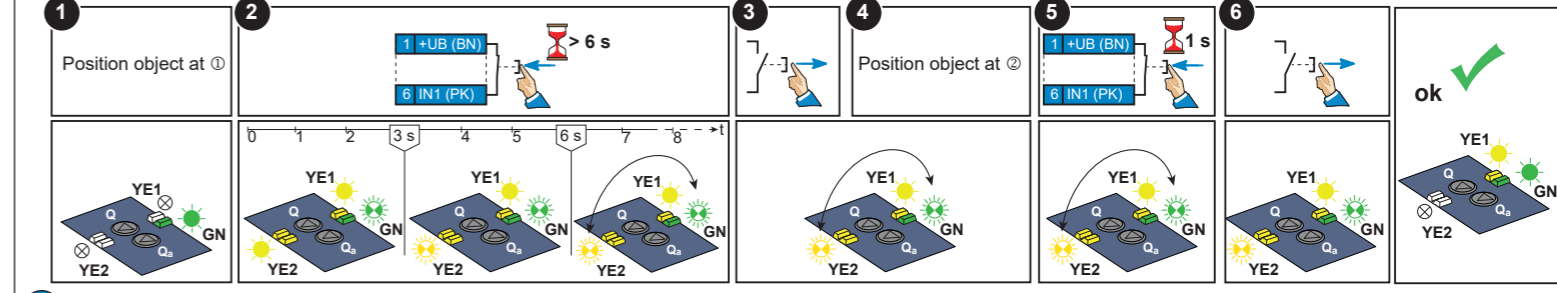

B Low signal disable in case of contactors use (otherwise the use is PLC)

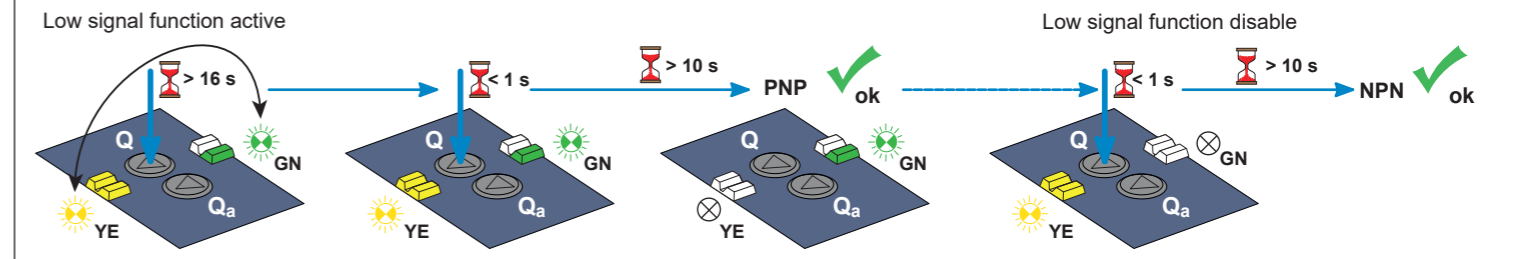

- Press Q > 16 s until green and yellow LED flash flash alternately.
- As long as the yellow and green LEDs are flashing, press the teach button for 1 s; the low signal function is active. The green LED shows the output status (PNP).
- When OK, do not push the button for 10 s. Setting is saved. Sensor is ready to operate.
- Press the teach button for 1 s; the low signal function is inactive. The yellow LED shows the output status (NPN). Every consecutive push/release will toggle the function, indicated by green or yellow LED.

To summarize:

- If the low signal is disabled:
- no feed back on Q1, Q2 after anticollision external teach or tandem teach.
  - Q1 and Q2 are modified, see "anticollision diagram" and "tandem diagram".

**C Beam off Function**

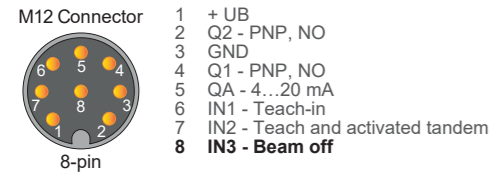

**Activation:**  
 IN 3 = Low → Run (tandem or anti-collision)  
 IN 3 = High → Diagnostic function, Laser off

- Response, if IN3 switches to high: (\*)
- If Q1 is high → low (or low → high)
  - If Q2 is high → low (or low → high)
  - QA must keep its values.

**Before beam-off, the cranes should be in Stop Condition!**

(\*): The response time between activation (IN3) and response (Q1 or Q2) is less than 500 ms.

**D Switching NPN / PNP**

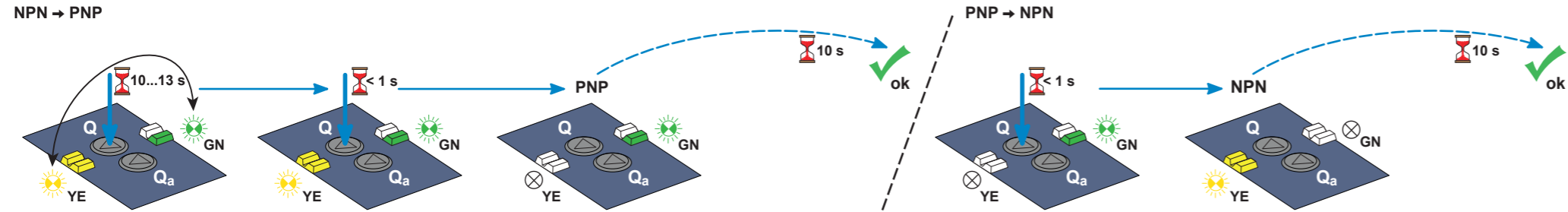

- Press Q 10 s...13 s until green and yellow LED flash alternatively.
- As long as the yellow and green LEDs are flashing, press the teach button for 1 s to invert the output. The green LED shows the output status (PNP).
- When OK, do not push the button for 10 s. Setting is saved. Sensor is ready to operate.
- Press the teach button for 1 s to invert the output. The yellow LED shows the output status (NPN). Every consecutive push/release will toggle the function, indicated by green or yellow LED.

**E Switching N.O./N.C.**

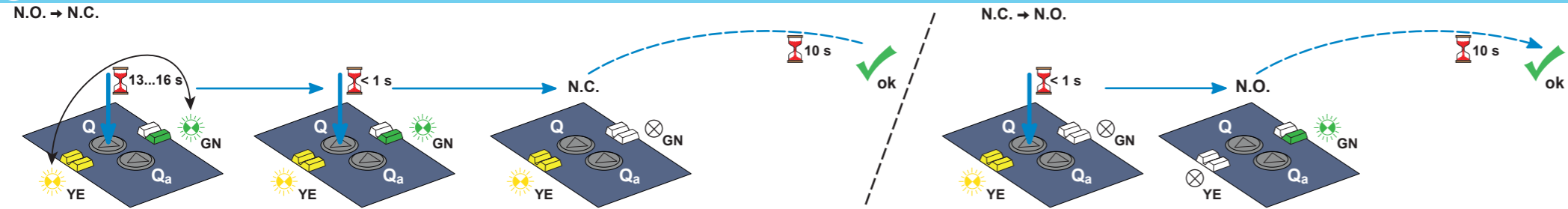

- Press Q 13 s...16 s until green and yellow LED flash at the same time.
- As long as the yellow and green LEDs are flashing, press the teach button for 1 s to invert the output. The yellow LED shows the output status (N.O.).
- When OK, do not push the button for 10 s. Setting is saved. Sensor is ready to operate.
- Press the teach button for 1 s to invert the output. The green LED shows the output status (N.C.). Every consecutive push/release will toggle the function, indicated by green or yellow LED.

**F Default Setting**

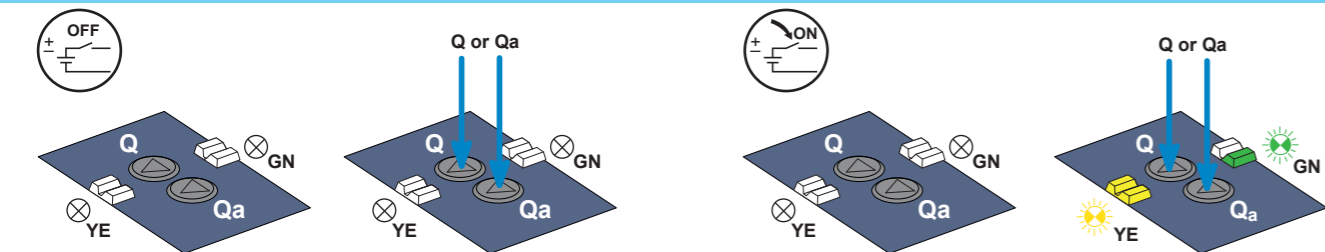

The sensor can be set back to the default setting.

**The sensor must not be in tandem mode.**

- Power supply OFF
- Press button Q or Qa
- Power supply ON
- Keep button pressed for 10 s until LEDs blink three times synchronously.