

Product Data Sheet

GW50620

GW FIT Range



Systems of accessories for electrical installations used for residential, tertiary and industrial applications. The system consists of fasteners for pipes and cables, cable fittings, accessories for rigid pipes (RK Series) and flexible conduit (DF Series). The system include also a wide variety of cable ties (52FS Range) and terminal blocks (44 Range).

Colour	Grey RAL 7035	Material	Shockproof polymer
Internal Ø (mm)	31-32	Description	Clip
Glow Wire Test	750 °C	For external conduits (mm)	31-32
Type	With pin	Operating temperature	-5 +60 °C
Type of material	Halogen-free in compliance with EN 60754-2	Electrocod	21221
Standard	EN 61386-1 (when applicable)		

DIMENSIONAL

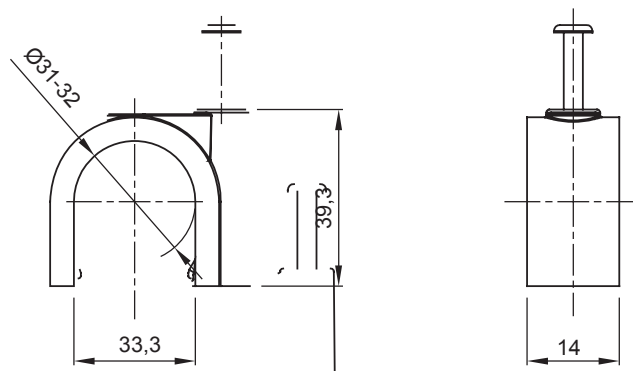

TECHNICAL SYMBOLOGY

GWT

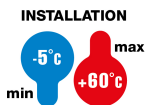

HF
HALOGEN FREE

750 °C

STANDARDS/APPROVALS

