

PRODUCT DATASHEET

DL IP44 DN 90 4W 830 WT

DOWNLIGHT IP44 | Downlights with IP44 grade



Areas of application

- Direct replacement for luminaires with fluorescent lamps
- General illumination
- Public areas
- Stairways
- Corridors
- Shops
- Bathrooms

Product benefits

- High luminous efficacy
- Very homogenous light
- Simple installation thanks to integrated driver

Product features

- Type of protection: IP44
- Luminous efficacy: 100 lm/W



TECHNICAL DATA

Electrical data

Nominal wattage	4.00 W
Nominal voltage	220...240 V
Mains frequency	50...60 Hz
Nominal current	30.000 mA
Inrush current	4.4 A
Inrush current time T_{h50}	250 μ s
Max. number of luminaires per miniature circuit breaker B16	373
Max. number of luminaires per miniature circuit breaker C10	200
Max. number of luminaires per miniature circuit breaker C16	320
Power factor λ	0.50
Total harmonic distortion	< 80 %
Protection class	II
Operating mode	Integrated LED driver

Photometrical data

Luminous flux	400 lm
Luminous efficacy	100 lm/W
Color temperature	3000 K
Light color (designation)	Warm White
Color rendering index Ra	> 80
Standard deviation of color matching	< 6 sdc _m
Low flicker	Yes
Photobiological safety group acc. to EN62778	RG0
Photobiological safety group acc. to EN62471	RG0
Beam angle	100 °

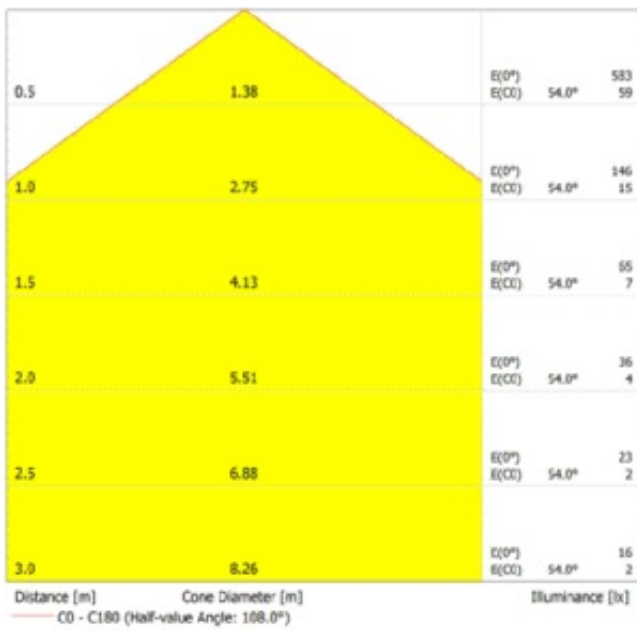

DL IP44 DN 90 4W

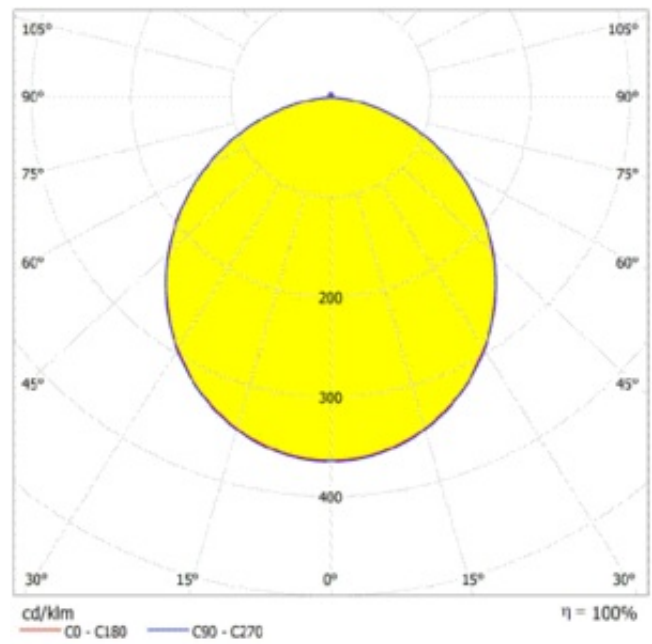

DL IP44 DN 90 4W

Dimensions & Weight

Diameter	90.00 mm
Height	42.00 mm
Product weight	50.00 g

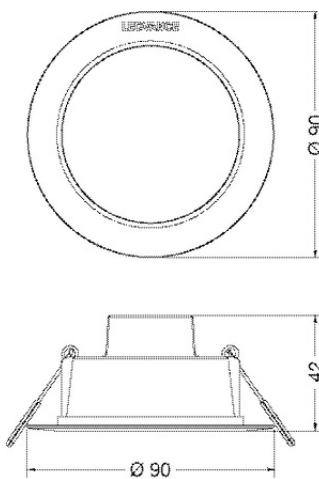

DL IP44 DN 90 4W

Materials & Colors

Product color	White
Housing color	White
Body material	Polycarbonate (PC)
Cover material	Polycarbonate (PC)
Light emitting surface material	Polycarbonate (PC)
Glow Wire Test according to IEC 60695-2-12	650 °C
Mercury content	0.0 mg

Application & Mounting

Ambient temperature range	-20...+40 °C
Temperature range at storage	-20...+80 °C
Type of connection	Cable, 2-pole
Type of protection	IP44
Protection class IK (shock resistance)	IK03
Dimmable	No
Mounting type	Recessed
Mounting location	Ceiling
Application environment	Indoor
Mounting diameter	75 mm
Mounting depth	40 mm
Adjustable	No
With light source	Yes

Lifespan

Lifespan L70/B50 at 25 °C	20000 h ¹⁾
Lifespan L80/B10 at 25 °C	18000 h ¹⁾
Lifespan L80/B50 at 25 °C	18000 h
Lifespan L90/B10 at 25 °C	15000 h
Number of switching cycles	100000

¹⁾ t[h]: L70 / B50 @ 25 °C (Ta), t[h]: L80 / B10 @ 25 °C (Ta), t[h]: L90 / B10 @ 25 °C (Ta)

Control gear

Output current	66 mA
ECG - Output ripple current	< 5 %

Certificates & Standards

Standards	CE / EMC / ROHS 2.0 / REACH
Luminaire with limited surface temperature, "D sign"	No
Ball shot safe	No
Replaceable light source (EPREL)	Not replaceable







Accessories Optional



Product image	Product name	EAN
	DL IP44 FRAME DN 90 WT	4058075709881





EQUIPMENT / ACCESSORIES



– Surface mounting frames available as accessories

DOWNLOAD DATA

Documents and certificates	Document name
 User instruction / safety instructions	DL IP44 DN 115 8W 830 WT
 Legal information	Informationstext 18 Abs 4 ElektroG
 Legal information	DL IP44 DN 115 8W 830 WT
 Legal information	DL IP44 DN WT
 Declarations of conformity	CE Declaration of Conformity DOWNLIGHT IP44 DN WT
 Declarations of conformity UKCA	UKCA Declaration of Conformity DOWNLIGHT IP44 DN WT

Photometric and lighting design files	Document name
 IES file (IES)	DL IP44 DN 90 4W 830 WT
 LDT file (Eulumdat)	DL IP44 DN 90 4W 830 WT

Photometric and lighting design files		Document name
	ULD file (DIALux)	DL IP44DN 90 4W 830 WT
	ROLF file (RELUX)	DL IP44 DN 90 4W 830 WT
	UGR file (UGR table)	DL IP44 DN 90 4W
	Light distribution curve type cone	DL IP44 DN 90 4W
	Light distribution curve type polar	DL IP44 DN 90 4W

CAD/BIM files		Document name
	BIM Revit 3D	DL IP44
	CAD STEP 3D	DL IP44 DN 90 4W WT

Tender texts		Document name
	Tender documents	DOWNLIGHT IP44 DN 90 4W 830 WT-EN

LOGISTICAL DATA

Product code	Packaging unit (Pieces/Unit)	Dimensions (length x width x height)	Gross weight	Volume
4058075702868	Folding box 1	95 mm x 51 mm x 95 mm	83.00 g	0.46 dm ³
4058075702875	Shipping box 10	269 mm x 200 mm x 111 mm	847.00 g	5.97 dm ³

The mentioned product code describes the smallest quantity unit which can be ordered. One shipping unit can contain one or more single products. When placing an order, for the quantity please enter single or multiples of a shipping unit.

ADDITIONAL CATALOG INFORMATION

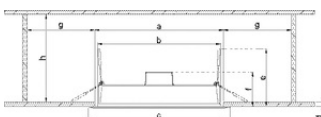

Model	a [mm]	b [mm]	c [mm]	d [mm]	e [mm]	f [mm]	g [mm]	h [mm]	i [mm]	j [mm]
DL IP44 DN90	Ø 75	Ø 58	Ø 30	3-25	Ø 6	42	-02	-70		
DL IP44 DN115	Ø 100	Ø 80	Ø 51	3-25	Ø 6	42	-02	-70		
DL IP44 DN165	Ø 160	Ø 140	Ø 101	3-25	Ø 6	42	-02	-70		
DL IP44 DN190	Ø 111	Ø 108	Ø 190	3-25	Ø 6	42	-02	-70		
DL IP44 DN215	Ø 200	Ø 154	Ø 215	3-25	Ø 6	42	-02	-70		

DISCLAIMER

Subject to change without notice. Errors and omission excepted. Always make sure to use the most recent release.