

**Connections, displays and operating elements**

**Room temperature control unit for properties**

**System M**

Operating instructions



Art. no MTN6221-03../MTN6221-04..

**Accessories**

- You have to complete the room control unit with a design frame System M.

**For your safety**



**DANGER**

**Risk of fatal injury from electrical current.**

The unit may only be installed and connected by skilled electricians. Observe the regulations valid in the country of use, as well as the valid KNX guidelines.

**Getting to know the controller**

The **room temperature control unit for properties** (referred to below as the **controller**) is designed for different types of property (school, hospital, public building, etc.). All settings relevant to room temperature control can only be parameterised using the KNX Tool Software (ETS). The controller has neither display nor operating elements so that it is protected against misuse by unauthorised persons.

**Functions of the room temperature control unit:**

- Heating / cooling with one controller output
- Heating / cooling with separate controller outputs
- Heating / cooling with two controller outputs
- Heating / cooling (2 levels) with four control outputs

The controller is directly connected to the KNX and parameterised by the electrician using the ETS.

**Scope of delivery**

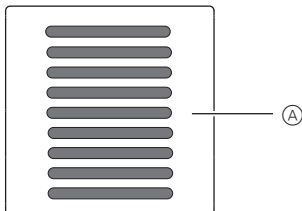

A Controller

**Installation side**

You must take the following points into consideration when selecting the installation location for the room temperature control unit in order for it to work optimally:

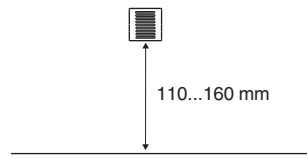
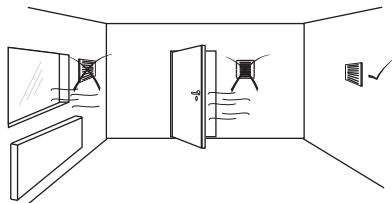

**Sources of interferences**

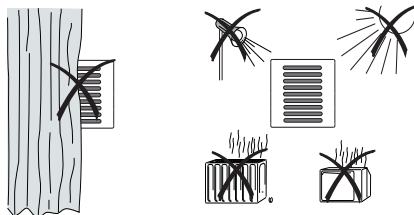

**Mounting the controller**

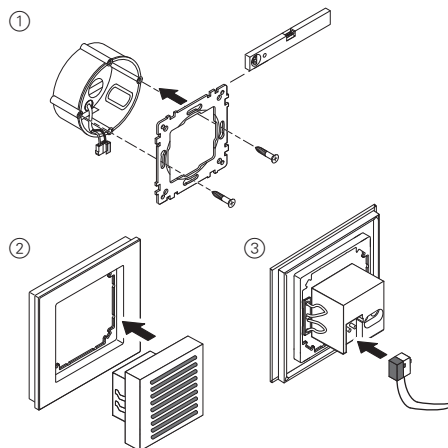

**Operating the controller**

① Set the controller to the programming state.

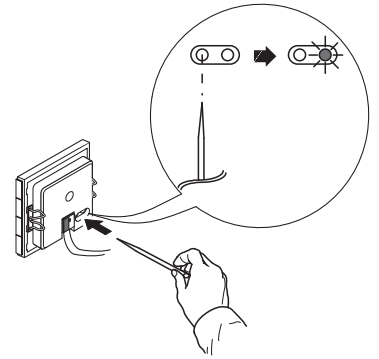

② Load the physical address and application from the ETS into the controller. The red programming LED goes out.

③

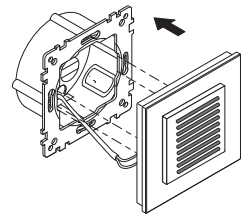

**Technical data**

Power supply:	via KNX
Connection:	Bus terminal connection
Measurement range:	0 to 40 °C
Measurement accuracy:	± 1 K, depends on installation location
Controller type:	Offset can be parameterised 2-point controller continuous PI controller switching PI controller (PWM)
Controller mode:	Heating with 1 controller output Cooling with 1 controller output Heating and cooling with separated controller outputs 2-stage heating with 2 controller outputs 2-stage cooling with 2 controller outputs 2-stage heating and 2-stage cooling with 4 controller outputs
Protection type:	IP 20

**Schneider Electric Industries SAS**

If you have technical questions, please contact the Customer Care Center in your country.

[www.schneider-electric.com](http://www.schneider-electric.com)

This product must be installed, connected and used in compliance with prevailing standards and/or installation regulations. As standards, specifications and designs develop from time to time, always ask for confirmation of the information given in this publication.