

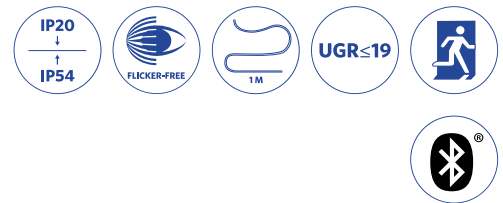

Paneel Performer UGR19 G5

- Hoogwaardig LED Slim Panel, geschikt voor gebruik in kantoren (UGR19)
- Inbouw, gependeld en opbouw mogelijk
- Tot 60% minder energieverbruik vergeleken met TL









Specificaties

Artikelcode	Artikelomschrijving	Equivalent (W)	Vermogen (W)	Lumen	Efficiëntie (lm/W)	CCT (K)	CRI	Gewicht (kg/st)
Smart Lighting								
542004069700	LEDPanelRc-S5 Sq595-30W-BLE-840-U19	TL 4x18W	30	3900	130	4000	≥ 80	2,49

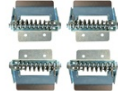
Verkrijgbaar op aanvraag met Wieland GST18- (-WL) of WAGO WINSTA-connector of Euro-/Schuko-stekker. DALI2 uitvoering compatibel met centrale noodverlichting volgens de norm EN 50172. BLE uitvoeringen in opbouw frames kunnen beperkte BLE signaalsterkte tot gevolg hebben.

Accessoires

Opbouw frame		Inbouw frame				
						
140055484 LEDPanelRc-SI Sq600-Surface-Module-WH-CT	542098017600 LEDPanelRc2 Sq600-Surface-Kit-WH	542098009600 LEDPanelRc Sq600-Frame-WH	140057770 LEDPanelRc-SI-Mounting-Springs-595	542098006900 LEDPanel-S4-Suspension-Kit	542098000800 LEDPanelRC-SI U19 EM-kit 1h	
						
140060852 LEDFixture-Ceiling-Cable-Kit-0.5m	542098030700 Junction-Box-WH					

Artikel- en verpakkingsinformatie

Artikel			Doosverpakking			
Artikelcode	Artikelomschrijving	Commodity Code	Afmetingen (mm) (LxBxH)	Brutogewicht (kg)	EAN	st/doos
542004069700	LEDPanelRc-S5 Sq595-30W-BLE-840-U19	94051190	661x695x46	3,57	6941497735751	1
140055484	LEDPanelRc-SI Sq600-Surface-Module-WH-CT	94059900	690x690x118	4,26	6956321879808	1
140057770	LEDPanelRc-SI-Mounting-Springs-595	73209090	80x80x53	0,50	6956321888121	1
140060852	LEDFixture-Ceiling-Cable-Kit-0.5m	73121020	100x100x5	0,40	6956321895266	1
140063563	LEDsmartlight-Rc-Sensor	85365005	100x100x70	0,19	6956321862602	1
140063564	LEDsmartlight-Switch	85365005	89x21x101	0,10	6956321862619	1
506006003100	LEDsmart-Relay-500W	85364900	37x110x57	0,10	6956321820824	1
542098000800	LEDPanelRC-SI U19 EM-kit 1h	85044082	490x390x150	0,98	6941497702340	1
542098000900	LEDPanelRC-SI U19 EM-kit 3h	85044082	490x390x150	1,08	6941497702333	1
542098006900	LEDPanel-S4-Suspension-Kit	73121020	130x130x30	0,22	6941497701428	1
542098009600	LEDPanelRc Sq600-Frame-WH	94059900	688x88x694	1,79	6941497704061	1
542098017600	LEDPanelRc2 Sq600-Surface-Kit-WH	94059900	800x330x230	1,53	6941497720696	1
542098030700	Junction-Box-WH	85369010	43x103.4x26	0,06	6941408868684	1
560000005700	Smart Connect Box	85176200	100x60x105	0,30	6941497711663	1
560000008400	LEDsmartlight-Rc-MW-Sensor	85365005	110x110x75	0,19	6941497726995	1
560098000600	LEDsmart-Sensor Surface-Module-WH	94059200	330x220x255	0,15	6941497703972	1
821017001100	LEDsmart-BLE-Multi-Switch-Module	94059200	46x46x30	0,07	6941408898476	1

Technische specificaties	
Levensduur (L70)	100.000 u
Levensduur (L80)	70.000 u
Levensduur (L90)	50.000 u
Aan-/Uit-cycli	100.000
Kleurconsistentie (SDCM)	3
Dimbaarheid	BLE
Bundelhoek	85°
Afwerking	Wit RAL9003
UGR	≤ 19
IP voorzijde	IP54
IP-klasse achterzijde	IP20
Slagvastheid	IK04
Beschermingsklasse	II
Risicogroep (EN 62471)	RG0
Voorschakelapparaat inbegrepen	Ja
Gloeidraadtest	650°C
Uitvalkans driver (bij 5.000 uur)	<1 %
Vermogensfactor	≥ 0,9

Elektrische aansluiting	
Frequentie	50/60 Hz
Nom. spanning	220-240 V AC
DC ingangsspanning	Zie catalogusbijlage Aansluitwaarden
230V Kabellengte	1 m

Materiaal eigenschappen	
Materiaal behuizing	Aluminium
Materiaal optiek	PMMA
Cover materiaal	Polystyreen

Toepassingscondities	
Bedrijfstemperatuur	-20-+40°C
Gebruikstemperatuur	+25°C
Opslagtemperatuur	-25-+50°C



ENERGY

OPPLE Lighting
542004069700

A **B** **C** **D** **E** **F** **G**

30
kWh/1000h

2019/2015

Maatschets (mm)

LEDPanelRc-S5 Sq595

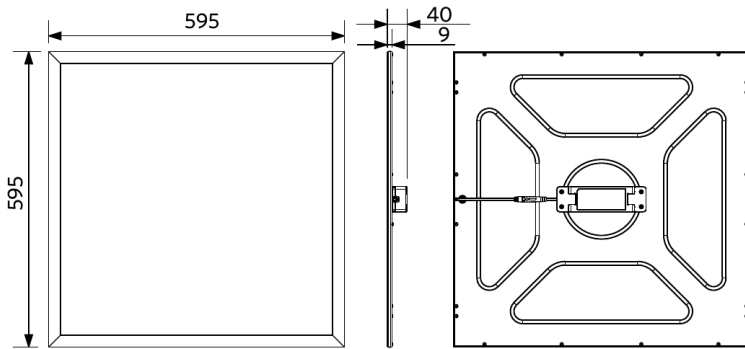

LEDPanelRc-S5
Driver On/Off

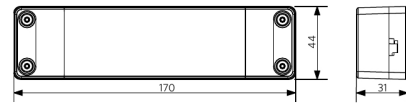

LEDPanelRc-S5
Driver Dim

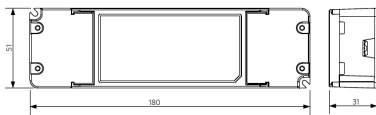

LEDPanelRc-S5
Driver Tunable White

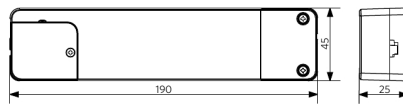

Fotometrische gegevens

