

XPSMCMx Fieldbus Expansion Modules

Instruction Sheet
(Original Language)

04/2018

The information provided in this documentation contains general descriptions and/or technical characteristics of the performance of the products contained herein. This documentation is not intended as a substitute for and is not to be used for determining suitability or reliability of these products for specific user applications. It is the duty of any such user or integrator to perform the appropriate and complete risk analysis, evaluation and testing of the products with respect to the relevant specific application or use thereof. Neither Schneider Electric nor any of its affiliates or subsidiaries shall be responsible or liable for misuse of the information contained herein. If you have any suggestions for improvements or amendments or have found errors in this publication, please notify us.

You agree not to reproduce, other than for your own personal, noncommercial use, all or part of this document on any medium whatsoever without permission of Schneider Electric, given in writing. You also agree not to establish any hypertext links to this document or its content. Schneider Electric does not grant any right or license for the personal and noncommercial use of the document or its content, except for a non-exclusive license to consult it on an "as is" basis, at your own risk. All other rights are reserved.

All pertinent state, regional, and local safety regulations must be observed when installing and using this product. For reasons of safety and to help ensure compliance with documented system data, only the manufacturer should perform repairs to components.

When devices are used for applications with technical safety requirements, the relevant instructions must be followed.

Failure to use Schneider Electric software or approved software with our hardware products may result in injury, harm, or improper operating results.

Failure to observe this information can result in injury or equipment damage.

© 2018 Schneider Electric. All Rights Reserved.

Table of Contents



About the Book	5
XPSMCMx Fieldbus Expansion Modules	7
LED Indicators	17



At a Glance

Document Scope

This information is about the usage and configuration of the following fieldbus expansion modules for the XPSMCMCP0802• Modular Safety Controller:

Reference	Interface
XPSMCMCO0000CO•	CANopen
XPSMCMCO0000EC•	EtherCAT
XPSMCMCO0000EI•	Ethernet/IP
XPSMCMCO0000EM•	Modbus TCP/IP
XPSMCMCO0000MB•	Modbus Serial (RTU)
XPSMCMCO0000PB•	PROFIBUS DP
XPSMCMCO0000UB•	USB

Validity Note

The characteristics that are presented in the present manual should be the same as those characteristics that appear online. In line with our policy of constant improvement, we may revise content over time to improve clarity and accuracy. If you see a difference between the manual and online information, use the online information as your reference.

Product Related Information

The XPSMCM• is built to the following safety integrity levels: SIL 3 according to EN/IEC 61508, SILcl 3 according to EN/IEC 62061, PL e category 4 according to EN ISO 13849-1 in accordance with the applicable standards. However, the definitive SIL and PL of the application depends on the number of safety-related components, their parameters, and the connections that are made, as per the risk analysis.

The module must be configured in accordance with the application-specific risk analysis and all the applicable standards.

Pay particular attention in conforming to any safety information, different electrical requirements, and normative standards that would apply to your adaptation.

WARNING

UNINTENDED EQUIPMENT OPERATION

Perform an in-depth risk analysis to determine the appropriate safety integrity level for your specific application, based on all the applicable standards.

Failure to follow these instructions can result in death, serious injury, or equipment damage.

NOTE: Configuration of the module is the sole responsibility of the installer or user.

For all matters concerning functional safety, if necessary, contact the competent safety authorities or the competent trade associations of your country.

Consult the specific product documentation and the relative product and/or application standards to ensure correct use of modules connected to the fieldbus expansion modules within your specific application.

The ambient temperature of the installed system must be compatible with the operating temperature parameters stated on the product label and in the product specifications.

XPSMCMx Fieldbus Expansion Modules

Safety-related Information

NOTE: The safety function can be compromised if this module is not used for the intended purpose and in accordance with the instructions in this document.

DANGER

HAZARD OF ELECTRIC SHOCK, EXPLOSION OR ARC FLASH

- Do not install, operate, or maintain this equipment unless you are a trained professional electrician and qualified to perform these activities.
- Install and use this equipment only in locations known to be non-hazardous.
- Do not use the equipment described herein to supply external drives or contactors.
- Use the same ground supply (0 Vdc) to supply all modules of the Modular Safety Controller family.
- Disconnect all power from all equipment including connected input devices, contactors, and drives prior to removing any covers or doors, or installing or removing any accessories, hardware, cables, or wires.
- If connected drives or contactors contain stored energy, allow sufficient time after the removal of power for the stored energy to discharge in accordance with the instructions for those drives and contactors.
- Always use a properly rated voltage sensing equipment to confirm that the power is removed.
- Avoid contacting terminals with hand or tools until the power has been confirmed removed.
- Follow all electrical safety regulations and standards (for example, lockout/tag-out, phase grounding, barriers) to reduce the possibility of contact with hazardous voltages in the work area.
- Remove locks, tags, barriers, temporary ground straps, and replace and secure all covers, doors, accessories, hardware, cables, and wires and confirm that a proper ground connection exists before reapplying power to the unit.
- Complete thorough hardware tests and system commissioning to verify that line voltages are not present on the control circuits before using your hardware operationally.
- Use only the specified voltage when operating this equipment and any associated products.

Failure to follow these instructions will result in death or serious injury.

DANGER

LOSS OF DESIGNATED SAFETY FUNCTION

- Install the XPSMCM• Modular Safety Controller system in an enclosure with a degree of protection of at least IP 54.
- Always use an isolated power supply (PELV) to help prevent the application of line voltages to control circuitry in the case of short-circuits.

Failure to follow these instructions will result in death or serious injury.

DANGER

POTENTIAL FOR EXPLOSION OR UNINTENDED EQUIPMENT OPERATION

- Install and use the Modular Safety Controller in non-hazardous locations only.
- Do not use the Modular Safety Controller system for life support systems.

Failure to follow these instructions will result in death or serious injury.

NOTE: The observation of operating limits and duty cycles is of particular importance for equipment designed to perform a safety-related function. If this module has been subjected to electrical, mechanical, or environmental stresses in excess of its stated limits, do not use it.

WARNING

UNINTENDED EQUIPMENT OPERATION

- Do not exceed any of the rated operating limits for the equipment specified in the present document.
- Immediately cease using and replace any equipment that has or might have been subjected to conditions in excess of its rated operating limits.

Failure to follow these instructions can result in death, serious injury, or equipment damage.

User Responsibilities

The information provided in this documentation contains general descriptions and/or technical characteristics of the performance of the products contained herein. This documentation is not intended as a substitute for and is not to be used for determining suitability or reliability of these products for specific user applications. It is the duty of any such user, machine builder, or system integrator to perform the appropriate and complete risk analysis, evaluation, and testing of the products with respect to the relevant specific application or use thereof.

Neither Schneider Electric nor any of its affiliates or subsidiaries shall be responsible or liable for misuse of the information contained herein. If you have any suggestions for improvements or amendments or have found discrepancies in this publication, notify Schneider Electric. All pertinent safety regulations must be observed when installing and using this product. For reasons of safety and to help ensure compliance with documented system data, only the manufacturer should perform repairs to components.

Qualified Personnel

Electrical equipment should be installed, operated, serviced, and maintained only by qualified personnel. A qualified person is one who has skills and knowledge related to the construction and operation of this electrical equipment and its installation, and has received safety training to recognize and avoid the hazards involved.

Module and Function Description

The XPSMCMCO0000CO(G), XPSMCMCO0000EC(G), XPSMCMCO0000EI(G), XPSMCMCO0000EM(G), XPSMCMCO0000MB(G), XPSMCMCO0000PB(G), and XPSMCMCO0000UB(G) are fieldbus expansion modules for the XPSMCM• Modular Safety Controller offer. The fieldbus expansion modules can only be configured in conjunction with the XPSMCMCP0802• Modular Safety Controller.

The fieldbus expansion modules can be configured using the bus configuration software, part of the install package for SoSafe Configurable software.

One fieldbus expansion module can be added to your Modular Safety Controller.

The following fieldbus expansion modules are available and contain the following interfaces:



Module reference	Interface	Type (short name in software and on product)
XPSMCMCO0000EI•	EtherNet/IP	EIP
XPSMCMCO0000MB•	Modbus Serial	MBS
XPSMCMCO0000CO•	CANopen	CAN
XPSMCMCO0000PB•	Profibus DP	PDP
XPSMCMCO0000EC•	EtherCAT	ECT
XPSMCMCO0000EM•	Modbus TCP/IP	MTP
XPSMCMCO0000UB•	Universal Serial Bus	USB

The fieldbus expansion module exports the system status and the states and diagnostics of all I/Os configured on the Modular Safety Controller.

The input and output memory maps are described in the *Modular Safety Controller User Guide*.

Terminals

Examples with maximum number of terminals. Regarding terminal designation, refer to table below.

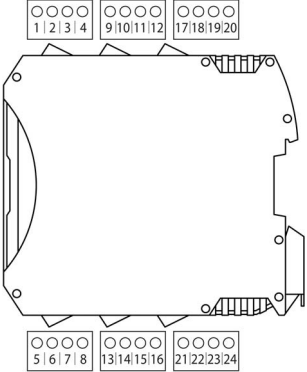
Screw terminals example	Spring terminals example	Terminal numbers
		

XPSMCMCO0000CO•, XPSMCMCO0000EC•, XPSMCMCO0000EI•,
 XPSMCMCO0000EM•, XPSMCMCO0000MB•, XPSMCMCO0000PB•,
 XPSMCMCO0000UB•

Terminal	Signal	LED	Type	Description	Operation
1	24 VDC	PWR	–	24 Vdc power supply	–
2	–	–	–	Not connected	–
3					
4	0 VDC	PWR	–	0 Vdc power supply	–
5	–	–	–	Not connected	–
6					
7					
8					

LED Indicators

For this information, refer to the LED Indicator chapter (*see page 17*).

Wiring Example

Fieldbus expansion modules

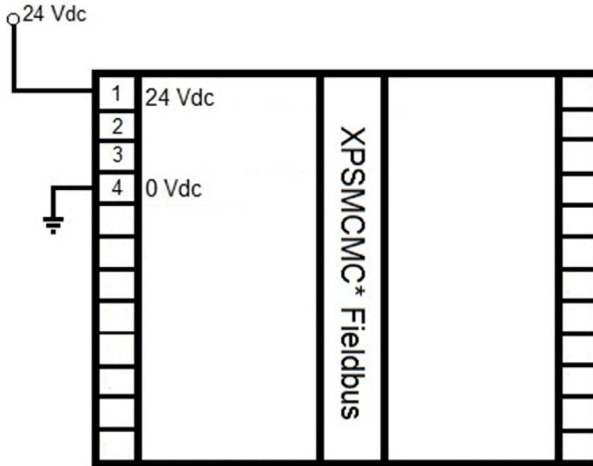



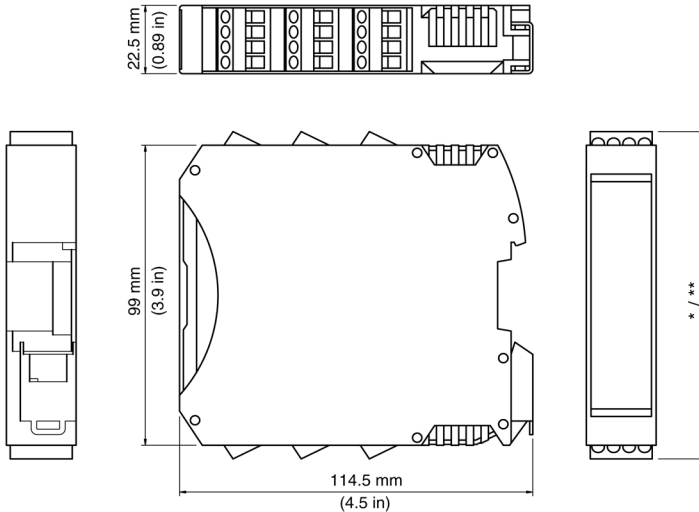







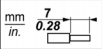





Dimensions

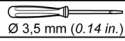

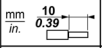
- * Screw terminals 108 mm (4.25 in)
- ** Spring terminals 118 mm (4.67 in)

Mount the modules (Modular Safety Controller and any I/O expansion modules) in an electric cabinet with an IP54 degree of protection. The minimum clearance below and above the controller is 40 mm. Allow at least 100 mm distance between the cabinet door and the front face of the module(s). There are no clearances required on the left or right side of the module(s); however, other equipment in proximity may require larger distances and those clearances must also be taken into account.

Technical Data

Cable types and wire sizes								
for a 5.08 pitch removable screw terminal block								
								
mm ²	0.2...2.5	0.2...2.5	0.25...2.5	0.25...1.5	2 x 0.2...1	2 x 0.2...1.5	2 x 0.25...1	2 x 0.5...1.5
AWG	24...14	24...14	23...14	23...16	2 x 24...18	2 x 24...16	2 x 23...18	2 x 20...16
		N·m		0.5				
		lb·in		4.42				
for a 5.08 pitch removable spring terminal block (used by XPSMCM***G).								
								
mm ²	0.2...2.5	0.2...2.5	0.25...2.5	0.25...2.5	2 x 0.5...1			
AWG	24...14	24...14	23...14	23...14	2 x 20...18			
The following instructions concerning connection cables must be observed:								
<ul style="list-style-type: none"> ● Use 60/75 °C copper (Cu) conductor only. Maximum cable length 100 m (328 ft). ● Cables used for connections of longer than 50 m (164 ft) must have a cross-section of at least 1 mm² (AWG 16). 								

Housing characteristics	
Housing material	Polyamide
Housing degree of protection	IP20
Terminal blocks degree of protection	IP2x
Mounting	35 mm DIN rail according to EN/IEC 60715
Mounting position	Any plane
Dimensions (h x l x d)	<ul style="list-style-type: none"> ● with screw terminals: 108 x 22.5 x 114.5 mm (4.25 x 0.89 x 4.5 in) ● with spring terminals: 118.5 x 22.5 x 114.5 mm (4.67 x 0.89 x 4.5 in)

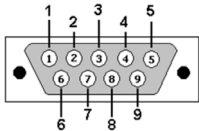
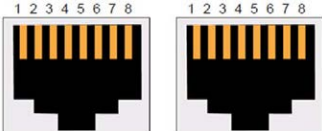

General characteristics	
Rated voltage	24 Vdc ± 20 % (PELV supply)
Dissipated power	3 W maximum
Overvoltage category	II
Ambient operating temperature	-10...+55 °C (14...131 °F)
Storage temperature	-20...+85 °C (-4...185 °F)
Relative humidity	10...95%
Maximum operation altitude	2000 m (6562 ft)
Pollution degree	2

General characteristics	
Vibration resistance (IEC/EN 61496-1)	+/- 3.5 mm (0.138 in) 5...8.4 Hz 1 g (8.4...150 Hz)
Shock resistance (IEC/EN 61496-1)	15 g (11 ms half-sine)
EMC Category	Zone B

Module-specific characteristics	XPSMCMCO0000CO•	XPSMCMCO0000EC•
Reference description	CAN: CANopen non-safety-related communication device	ECT: EtherCAT non-safety-related communication device
Weight	0.12 kg (4.2 Oz)	
Output and PIN number	CAN (CANopen)  DB9 - male	ECT (EtherCAT)  RJ45 - female
Wiring	Pin/ Signal 1/ not connected 2/ CAN_L 3/ CAN_GND 4/ not connected 5/ CAN_SHLD 6/ not connected 7/ CAN_H 8/ not connected 9/ not connected Housing CAN_SHIELD	PIN/Signal 1/ Tx+ 2/Tx- 3/Rx+ 4/not connected 5/not connected 6/Rx- 7/not connected 8/not connected
Baud rate	from 10kbit/s to 1Mbit/s	100 Mbit/s (full duplex)
Mini B-USB	Use for configuration of the fieldbus module address and baud rates together with fieldbus configurator software	
Data sets	Input status, input diagnostics, fieldbus input status, fieldbus probe status, safety-related output status, safety-related output diagnostics	

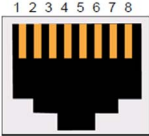
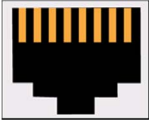
Module-specific characteristics	XPSMCMCO0000EI•	XPSMCMCO0000EM•
Reference description	EIP: EtherNet/IP non-safety-related communication device	MTP (Modbus TCP/IP) standard communication device
Weight	0.12 kg (4.2 Oz)	

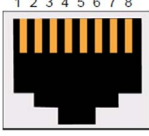
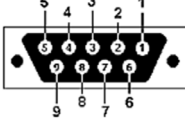
Module-specific characteristics	XPSMCMCO0000EI•	XPSMCMCO0000EM•
Output and PIN number	 RJ45- female	MTP (Modbus TCP)  RJ45- female
Wiring	PIN/ Signal 1/ Tx+ 2/ Tx- 3/ Rx+ 4/ not connected 5/ not connected 6/ Rx- 7/ not connected 8/ not connected	PIN/ Signal 1/ Tx+ 2/ Tx- 3/ Rx+ 4/ not connected 5/ not connected 6/ Rx- 7/ not connected 8/ not connected
Baud rate	10/100 Mbit, full/half duplex	
Mini B-USB	Use for configuration of the fieldbus module address and baud rate using the BUSConfigurator software	
Data sets	Input status, input diagnostics, fieldbus input status, fieldbus probe status, safety-related output status, safety-related output diagnostics	

Module-specific characteristics	XPSMCMCO0000MB•	XPSMCMCO0000PB•	XPSMCMCO0000UB•
Reference description	MBS (Modbus Serial) standard communication device	PDP (Profibus DP V1) standard communication device	USB (USB) communication device
Weight	0.12 kg (4.2 Oz)		
Output and PIN number	MBS (Modbus Serial)  RJ45 - female	PDP (Profibus DP)  DB9 – female	USB (USB)  Mini B-USB

Module-specific characteristics	XPSMCMCO0000MB•	XPSMCMCO0000PB•	XPSMCMCO0000UB•
Wiring	PIN/Signal/ Description 1/ not connected 2/ not connected 3/ not connected 4/ D1 5/ D0 6/ not connected 7/ VP (2) 8/ Common housing/cable shield	PIN/Signal/ Description 1 / not connected 2 / not connected 3 / B Line / + RxD/TxD, RS485 level 4 / RTS / Request to send 5 / GND Bus/ 0 Vdc (isolated)) 6 / 5 V / +5 V Bus Output / +5V termination power (isolated, short-circuit protected) 7 / not connected 8 / A Line / - RxD/TxD, RS485 level 9 / not connected housing/cable shield	PIN/Signal/Comment 1/ +5 V/ +5 V input 2/ USBDM/ USB communication signal 3/ USBDO/ USB communication signal 4/ GND/ Signal GND Housing/ Shield/ Cable shield
Slot for memory card	No (Modular Safety Controller only)		
Baud rate	up to 115200 bps	Auto Baud rate	up to 921.6 kbps
Mini B-USB	Use for configuration of the fieldbus module address and baud rates together with fieldbus configurator software		
Data sets	Input status, input diagnostics, fieldbus input status, fieldbus probe status, safety-related output status, safety-related output diagnostics		

Checklist After Installation

The following must be verified:

Step	Action
1	Conduct a full functional test of the system (see <i>Validation</i> in the <i>Modular Safety Controller User Guide</i> .)
2	Verify that all the cables are correctly inserted and the terminal blocks are within correct torque for screw terminals.
3	Verify that all the LED indicators are correctly illuminating for the inputs and outputs used.
4	Verify the positioning and function of all input and output sensors and actuators used with the XPSMCM•.
5	Verify the correct mounting of XPSMCM• to the DIN rail.
6	Verify that all the external indicators (lamps/beacons/sirens) are correctly functioning.

EC Declaration of Conformity



EC DECLARATION OF CONFORMITY

Copy of Document-no.: NHA3417601.00
Original Language

WE: **Schneider Electric Automation GmbH** / Schneiderplatz 1 / Marktheidenfeld 97828, Germany

hereby declare that the safety component

TRADEMARK: **SCHNEIDER ELECTRIC**

PRODUCT, TYPE: Modular Safety Controller – Communication Modules, Accessories

MODELS: XPSMCMCO0000CO*, XPSMCMCO0000DN*, XPSMCMCO0000EC*, XPSMCMCO0000EI*,
XPSMCMCO0000EI2*, XPSMCMCO0000EM*, XPSMCMCO0000EP*, XPSMCMCO0000MB*,
XPSMCMCO0000PB*, XPSMCMCO0000UB*,
XPSMCMCN0000SG, TSXS CMCN**, TSXESPPM**, TSXESPP3**

SERIAL NUMBER: YYXXZZZZ (YY: 10...99, XX: 01...53, ZZZZ: 0001...9999)

DATE OF MANUFACTURING: refer to device nameplate

all the essential protection requirements that are described in the following directives are defined, corresponding.
Furthermore, the conformity with the following harmonized European standards explained:

DIRECTIVE:	HARMONIZED STANDARD:
DIRECTIVE 2004/108/EC OF THE EUROPEAN PARLIAMENT AND OF THE COUNCIL (EMC) of 15 December 2004 on the approximation of the laws of the Member States relating to electromagnetic compatibility and repealing Directive 89/336/EEC	EN 61131-2:2007
DIRECTIVE 2011/65/EC OF THE EUROPEAN PARLIAMENT AND OF THE COUNCIL (RoHS) of 8 June 2011 on the restriction of the use of certain hazardous substances in electrical and electronic equipment	EN 50581:2012

It is important that the safety component is subject to correct installation, maintenance and use conforming to its intended purpose, to the applicable regulations and standards, to the supplier's instructions and to accepted rules of the art.

First year of affixing CE marking: 2014

Marktheidenfeld, Germany
December 1st, 2014

i.A. Michael Schweizer
Machine Solutions Certification Manager

The original EC Declaration of Conformity is available on our website: www.schneider-electric.com

LED Indicators

Front-Face View



Common LEDs for Operation

The following table describes the states of the common LED indicators of the fieldbus expansion modules:

PWR green	RUN green	E IN red	E EX red	First module- specific LED ¹	Second module- specific LED ¹	Meaning
ON	ON	ON	ON	ON	ON	Startup - Initial test
ON	Flashing	OFF	OFF	OFF	OFF	Waiting for configuration from the Modular Safety Controller
ON	ON	OFF	OFF	See the module-specific tables below ¹		Received configuration from the Modular Safety Controller

¹ Two LEDs indicate the communication protocol status. These LEDs are described in the following module-specific tables.

Common LED Indicators for Troubleshooting

The following table describes the states of the common LED indicators between the different communication expansion modules, assuming the power (PWR) indicator is illuminated:

Detected error	RUN green	E IN red	E EX red	First module-specific LED ¹	Second module-specific LED ¹	Solution
Internal microcontroller error detected.	OFF	2 flashes	OFF	See the module-specific tables below ¹		Replace the product if the condition persists
Internal board error detected.	OFF	3 flashes	OFF			
Configuration error detected.	OFF	5 flashes	OFF			Verify correct configuration.
Bus communication error detected.	OFF	5 flashes	OFF			Verify the fieldbus connections.
Bus communication interruption detected.	OFF	ON	OFF			Verify wiring, connectors, and state of the fieldbus master.
Duplicate addresses detected on the fieldbus.	OFF	5 flashes	5 flashes			Set a correct fieldbus address
¹ Two LEDs indicate the communication protocol status. These LEDs are described in the following module-specific tables.						

NOTE: The LED frequency of flashing is: ON for 300 ms and OFF for 400 ms with an interval between flash sequences of 1 s.

XPSMCMCO0000CO • CANopen

The following table presents the LED indicator **CAN RUN**:

State	Indication
OFF	No power
Steady green	Online, connected
Flashes slow green	Operating state Pre-Operational
Periodic single green flash	Operating state Stopped
Flashes fast green	Baud rate detection in progress.
Steady red	Bus not operational.
Operating states mentioned in the table according to the CANopen state machine	

The following table presents the LED indicator **ERR**:

State	Indication
OFF	No error detected

State	Indication
Periodic single red flash	A bus error counter has reached an alert level.
Fast red flashing	Layer Setting Service (LSS) operational.
Periodic double red flash	Life guarding event: detected node guarding or heartbeat not detected.
Steady red	Bus not operational.

XPSMCMCO0000EC EtherCAT

The following table presents the LED indicator **RUN**:

State	Indication
OFF	Operating state Init or no power
Green	Operating state Operational
Flashes green	Operating state Pre-Operational
Flashes green once	Operating state Safe-Operational
Red	System locked
Operating states mentioned in the table according to the EtherCAT state machine	

The following table presents the LED indicator **ERR**:

State	Indication
OFF	No error or no power
Flashes red	Configuration not valid. Operating state transition requested by master not possible.
Flashes red twice	Timeout EtherCAT SynchManager watchdog.
Red	Error detected, fieldbus module not operational.

XPSMCMCO0000EI• EtherNet/IP Module

The following table presents the LED indicator **EIP NS**:

State	Indication
OFF	No power or no IP address.
Steady green	Online, connected. One or more connections established (CIP Class 1 or 3)
Green flashing	Online, not connected.
Steady red	Duplicate IP address.
Red flashing	Connection timeout, one or more connections timed out (CIP class 1 or 3)

The following table presents the LED indicator **MS**:

State	Indication
OFF	No power
Operating states mentioned in the table according to the EtherNet/IP state machine	

State	Indication
Steady green	Operating state Operational
Green flashing	Not configured or Scanner is idle.
Steady red	One or more non-recoverable errors detected.
Red flashing	One or more recoverable errors detected.
Operating states mentioned in the table according to the EtherNet/IP state machine	

XPSMCMCO0000MB• Modbus Serial

The following table presents the LED indicator **MBS COM**:

State	Indication
OFF	No power or no data exchange
Yellow	Frame reception or transmission
Steady red	One or more non-recoverable errors detected.

The following table presents the LED indicator **STS**:

State	Indication
OFF	No power or initializing.
Steady green	Module initialized.
Steady red	One or more non-recoverable errors detected.
Periodic single red flash	Communication or configuration error detected.
Periodic double red flash	Application diagnostics available.

XPSMCMCO0000EM• Modbus TCP/IP

The following table presents the LED indicator **MTP NET**:

State	Indication
OFF	No power or no IP address
Steady green	Online, connected
Flashes green	Online, not connected
Steady red	Duplicate IP address
Flashes red	Connection timeout

The following table presents the LED indicator **STS**:

State	Indication
OFF	No power
Steady green	Running
Flashes green	Not configured
Steady red	One or more non-recoverable errors detected.

State	Indication
Flashes red	One or more recoverable errors detected.

XPSMCMCO0000PB• Profibus DP

The following table presents the LED indicator **PDP MODE**:

State	Indication
OFF	No power
Steady green	Online, connected
Green flashing	Online, clear
Periodic single red flash	Parameterization error detected.
Periodic double red flash	Profibus DP configuration error detected (configuration data in master or slave incorrect).

The following table presents the LED indicator **STS**:

State	Indication
OFF	Module not initialized
Green flashing	Diagnostics exchange active with master.
Steady green	Initialized
Red flashing (1 Hz)	One or more recoverable errors detected.
Steady red	Non-recoverable error detected.

XPSMCMCO0000UB• USB

There are no specific LED indicators for this reference, refer to general tables for the operation states (*see page 17*) and the troubleshooting (*see page 18*).