

DIN Track Push-in Terminal Blocks

XW5T

Push-in Plus Terminal Blocks to Downsize Control Panels and Save Work



- Push-in Plus terminal blocks are more compact than traditional screw terminal blocks.
No loosening means maintenance-free application.
- Slim models available down to a width of 3.5 mm to help downsize control panels.
- Light insertion force and strong holding strength to achieve both less wiring work and high reliability.
- 'Hands-free' structure that holds an inserted screwdriver to achieve better workability when wiring stranded wires without crimp terminals.

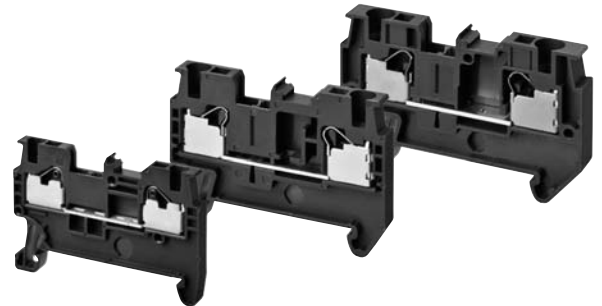

For the most recent information on models that have been certified for safety standards, refer to your OMRON website.

 Refer to *Safety Precautions* on page 17.

Model Number Legend



Feed Through Terminal Blocks

XW5T - P
(1) (2) (3)(4)

(1) Maximum Applicable Stranded Wire

1.5: 1.5mm²
2.5: 2.5mm²
4.0: 4.0mm²

(2) Wiring

1.1: 1:1 
1.2: 1:2 
2.2: 2:2 

Grounding Terminal Blocks

XW5G - P
(1) (2) (3)

(3) Number of Tiers

1: 1 tier
2: 2 tiers

(4) Color

Blank: Dark gray
BL: Blue

Part Names and Configuration

DIN Track Terminal Block (Top Surface)

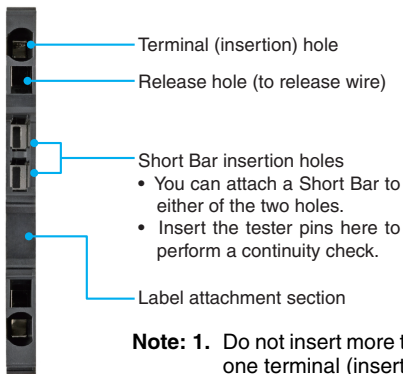

- Note:**
1. Do not insert more than one wire into one terminal (insertion) hole.
 2. Do not insert more than one Short Bar into one Short Bar insertion hole.

Basic Configuration

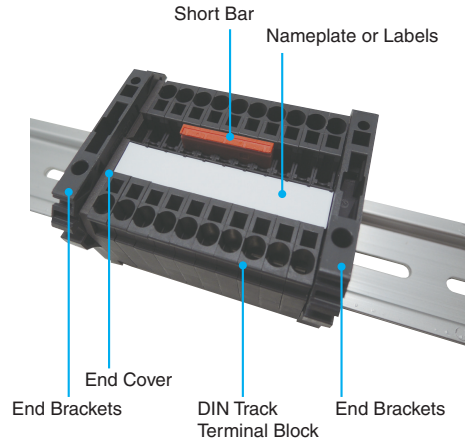

Name	Description
DIN Track Terminal Blocks	Both Feed Through and Grounding Terminal Blocks are available.
End Cover	This part is required to prevent electric shock. Attach one End Cover to the exposed metal surface of the last Terminal Block or to any Terminal Block that is next to a different shape of Terminal Block.
End Brackets	End Brackets must be attached to both ends to hold the Terminal Block in place.
Nameplate or Labels	This part is available as an accessory. Select the most suitable one for your needs. You can also use commercially available nameplates that are 9.5 mm wide and 0.5 mm thick on the top. *
Short Bar	This part is available as an accessory. Select one as required.

* Do not use on the side. Two-tier Terminal Blocks with a width of 3.5 mm are excluded.

Ordering Information

Classification	Product Type	Applicable wire sizes * (mm ²)	Number of levels	Number of cramp position per level	Color	Weight (gram)	Model
Feed Through Terminal blocks	Standard terminals	0.08 to 1.5	1	2	Dark grey	3.3	XW5T-P1.5-1.1-1
		0.14 to 2.5	1	2		6.3	XW5T-P2.5-1.1-1
		0.2 to 4.0	1	2		8.4	XW5T-P4.0-1.1-1
		0.08 to 1.5	1	2	Blue	3.3	XW5T-P1.5-1.1-1BL
		0.14 to 2.5	1	2		6.3	XW5T-P2.5-1.1-1BL
		0.2 to 4.0	1	2		8.4	XW5T-P4.0-1.1-1BL
	Multi tiers terminal	0.08 to 1.5	2	2	Dark grey	6.5	XW5T-P1.5-1.1-2
		0.14 to 2.5	2	2		12.5	XW5T-P2.5-1.1-2
		0.2 to 4.0	2	2		16.5	XW5T-P4.0-1.1-2
		0.08 to 1.5	2	2	Blue	6.5	XW5T-P1.5-1.1-2BL
		0.14 to 2.5	2	2		12.5	XW5T-P2.5-1.1-2BL
		0.2 to 4.0	2	2		16.5	XW5T-P4.0-1.1-2BL
	Multi conductor terminals	0.08 to 1.5	1	3	Dark grey	4.1	XW5T-P1.5-1.2-1
						8.2	XW5T-P2.5-1.2-1
						10.8	XW5T-P4.0-1.2-1
		0.14 to 2.5	1	3	Blue	4.1	XW5T-P1.5-1.2-1BL
						8.2	XW5T-P2.5-1.2-1BL
						10.8	XW5T-P4.0-1.2-1BL
		0.2 to 4.0	1	3	Dark grey	4.9	XW5T-P1.5-2.2-1
						10.4	XW5T-P2.5-2.2-1
						13.4	XW5T-P4.0-2.2-1
		0.08 to 1.5	1	4	Blue	4.9	XW5T-P1.5-2.2-1BL
						10.4	XW5T-P2.5-2.2-1BL
						13.4	XW5T-P4.0-2.2-1BL
Grounding Terminal blocks	Standard terminals	0.08 to 1.5	1	2	Green/yellow	4.7	XW5G-P1.5-1.1-1
		0.14 to 2.5	1	2		9.9	XW5G-P2.5-1.1-1
		0.2 to 4.0	1	2		11.8	XW5G-P4.0-1.1-1
	Multi tiers terminal	0.08 to 1.5	2	2		8.1	XW5G-P1.5-1.1-2
		0.14 to 2.5	2	2		16.6	XW5G-P2.5-1.1-2
		0.2 to 4.0	2	2		20.8	XW5G-P4.0-1.1-2
	Multi conductor terminals	0.08 to 1.5	1	3		5.5	XW5G-P1.5-1.2-1
		0.14 to 2.5	1	3		11.6	XW5G-P2.5-1.2-1
		0.2 to 4.0	1	3		14.1	XW5G-P4.0-1.2-1
		0.08 to 1.5	1	4		6.3	XW5G-P1.5-2.2-1
		0.14 to 2.5	1	4		13.8	XW5G-P2.5-2.2-1
		0.2 to 4.0	1	4		16.7	XW5G-P4.0-2.2-1

* For stranded wires.

Accessories

Short Bars

For XW5T-P1.5-□

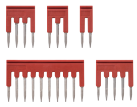
Appearance	No. of poles	Colors	Model*	Application
	2	Red (RD) Blue (BL) Yellow (YL)	XW5S-P1.5-2□	Used for cross-over wiring between Terminal Blocks.
	3		XW5S-P1.5-3□	
	4		XW5S-P1.5-4□	
	5		XW5S-P1.5-5□	
	10		XW5S-P1.5-10□	

* Replace the box (□) in the model number with the code for the covering color. Specify the color: RD = red, BL = blue, YL = yellow

For XW5T-P2.5-□

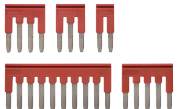
Appearance	No. of poles	Colors	Model*	Application
	2	Red (RD) Blue (BL) Yellow (YL)	XW5S-P2.5-2□	Used for cross-over wiring between Terminal Blocks.
	3		XW5S-P2.5-3□	
	4		XW5S-P2.5-4□	
	5		XW5S-P2.5-5□	
	10		XW5S-P2.5-10□	

* Replace the box (□) in the model number with the code for the covering color. Specify the color: RD = red, BL = blue, YL = yellow

XW5T

For XW5T-P4.0-□

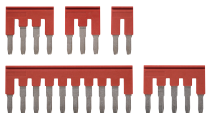
Appearance	No. of poles	Colors	Model*	Application
	2	Red (RD) Blue (BL) Yellow (YL)	XW5S-P4.0-2□	Used for cross-over wiring between Terminal Blocks.
	3		XW5S-P4.0-3□	
	4		XW5S-P4.0-4□	
	5		XW5S-P4.0-5□	
	10		XW5S-P4.0-10□	

* Replace the box (□) in the model number with the code for the covering color. Specify the color: RD = red, BL = blue, YL = yellow

Labels

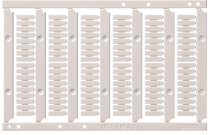
Appearance	Applicable Terminal Blocks	Model	Minimum order in sheets (quantity per sheet)	Application
	XW5□-P1.5-□	XW5Z-P1.5LB1	5 sheets with 102 top labels per sheet	Used to identify wiring. (Material: PA resin, blank)
		XW5Z-P1.5LB2	5 sheets with 108 side labels per sheet	
	XW5□-P2.5-□	XW5Z-P2.5LB1	5 sheets with 72 top labels per sheet	
		XW5Z-P2.5LB2	5 sheets with 72 side labels per sheet	
	XW5□-P4.0-□	XW5Z-P4.0LB1	5 sheets with 60 top labels per sheet	
		XW5Z-P4.0LB2	5 sheets with 60 side labels per sheet	

Note: 1. Different models are used for the top and side surfaces.

2. There is no place to mount the Top-surface Labels on Two-tier Terminal Blocks with a width of 3.5 mm, so they cannot be used.

3. Use commercially available nameplates (9.5 mm wide, 0.5 mm thick) on the top only. Do not use on the side. You can also use a commercially available printer. Check with the manufacturer of the nameplates for information on applicable printers.

4. Refer to page 20 for details on printing labels.

End Cover

Appearance	Applicable Terminal Blocks	Model	Application
	XW5□-P1.5-1.1-1	XW5E-P1.5-1.1-1	This part is required to prevent electric shock. Always mount End Covers to the following locations when you use Terminal Blocks. (For details, refer to page 21.) • Exposed metal surface of the last Terminal Block • Any Terminal Block that is next to a different shape of Terminal Block
	XW5□-P1.5-1.1-2	XW5E-P1.5-1.1-2	
	XW5□-P1.5-1.2-1	XW5E-P1.5-1.2-1	
	XW5□-P1.5-2.2-1	XW5E-P1.5-2.2-1	
	XW5□-P2.5-1.1-1	XW5E-P2.5-1.1-1	
	XW5□-P2.5-1.1-2	XW5E-P2.5-1.1-2	
	XW5□-P2.5-1.2-1	XW5E-P2.5-1.2-1	
	XW5□-P2.5-2.2-1	XW5E-P2.5-2.2-1	
	XW5□-P4.0-1.1-1	XW5E-P4.0-1.1-1	
	XW5□-P4.0-1.1-2	XW5E-P4.0-1.1-2	
	XW5□-P4.0-1.2-1	XW5E-P4.0-1.2-1	
	XW5□-P4.0-2.2-1	XW5E-P4.0-2.2-1	

End Brackets

Appearance	Width (mm)	Model	Application
	6	XW5Z-EP6	End Brackets are installed on the ends of the Terminal Blocks to prevent them from moving on the DIN Track.

Separator Plates

Appearance	Width (mm)	Model	Application
	12	XW5Z-EP12	This part is used to create insulation distance. Use Separator Plates according to the clearance and creeping distances required by the operating conditions of your equipment.

Note: Refer to 6. Using the Accessories on page 20 for information on using the accessories.

Ratings and Performance

Ratings

Feed Through Terminal blocks Standard terminals

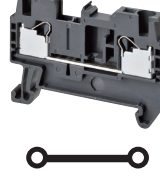
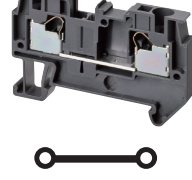
Model		XW5T-P1.5-1.1-1 (BL)				XW5T-P2.5-1.1-1 (BL)				XW5T-P4.0-1.1-1 (BL)			
		1 tier, 1:1				1 tier, 1:1				1 tier, 1:1			
Appearance and internal wiring													
Applicable wire sizes*1	Stranded wire	0.08 mm ² to 1.5 mm ²				0.14 mm ² to 2.5 mm ²				0.2 mm ² to 4.0 mm ²			
	Solid wire	0.14 mm ² to 1.5 mm ²				0.14 mm ² to 4.0 mm ²				0.2 mm ² to 6.0 mm ²			
	Stranded wire with ferrule with Plastic sleeve	0.14 mm ² to 0.75 mm ² (1.5 mm ²) *2				0.14 mm ² to 2.5 mm ²				0.25 mm ² to 4.0 mm ²			
Dimensions		3.5 × 45 × 30.5				5.2 × 48.8 × 35.3				6.2 × 56.1 × 35.3			
Rated voltage		500 V				800 V							
Rated current *3		17.5 A				24 A				32 A			
IEC rated voltage		500 V				800 V				800 V			
IEC rated current *3		17.5 A/1.5 mm ²				24 A/2.5 mm ²				32 A/4.0 mm ²			
Usage Group (UG)		B, C		D		B, C							
UL rated voltage		300 V	51-150 V	151-300 V	301-600 V	600 V							
UL rated current *3		15 A/AWG14 (SOL) 10 A/AWG16	15 A/AWG14 (SOL) 10 A/AWG16	10 A/AWG16	5 A/AWG16-20	20 A/AWG12 (SOL), 15 A/AWG14				30 A/AWG10 (SOL), 20 A/AWG12			
Dielectric strength		1,890 VAC for 1 min (leakage current: 1 mA max.)				2,000 VAC for 1 min (leakage current: 1 mA max.)				2,000 VAC for 1 min (leakage current: 1 mA max.)			
End Cover		XW5E-P1.5-1.1-1				XW5E-P2.5-1.1-1				XW5E-P4.0-1.1-1			
Special tool		XW4Z-00B				XW4Z-00B				XW4Z-00B			
Applicable nameplates		XW5Z-P1.5LB□ or commercially available nameplate with 9.5 mm width and 0.5 mm thickness				XW5Z-P2.5LB□ or commercially available nameplate with 9.5 mm width and 0.5 mm thickness				XW5Z-P4.0LB□ or commercially available nameplate with 9.5 mm width and 0.5 mm thickness			
Applicable Short Bars		XW5S-P1.5-□ (□: Poles = 2, 3, 4, 5 or 10)				XW5S-P2.5-□ (□: Poles = 2, 3, 4, 5 or 10)				XW5S-P4.0-□ (□: Poles = 2, 3, 4, 5 or 10)			

*1. For the recommended applicable wire ranges, refer to page 17 for solid and stranded wires, and to page 19 for ferrules.

*2. You can also use ferrules for 1.0 to 1.5 mm² wires if you use ferrules without insulation sleeve. Refer to page 19 for details.

*3. Do not apply more than the rated current to the terminal block.

Feed Through Terminal blocks Multi tiers terminal

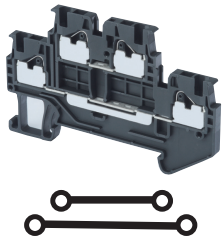
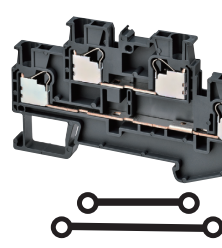
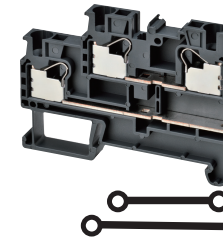
Model		XW5T-P1.5-1.1-2 (BL)	XW5T-P2.5-1.1-2 (BL)	XW5T-P4.0-1.1-2 (BL)			
Appearance and internal wiring		2 tiers, 1:1 	2 tiers, 1:1 	2 tiers, 1:1 			
Applicable wire sizes*1	Stranded wire	0.08 mm ² to 1.5 mm ²	0.14 mm ² to 2.5 mm ²	0.2 mm ² to 4.0 mm ²			
	Solid wire	0.14 mm ² to 1.5 mm ²	0.14 mm ² to 4.0 mm ²	0.2 mm ² to 6.0 mm ²			
	Stranded wire with ferrule with Plastic sleeve	0.14 mm ² to 0.75 mm ² (1.5 mm ²) *2	0.14 mm ² to 2.5 mm ²	0.25 mm ² to 4.0 mm ²			
Dimensions		3.5 × 65.7 × 41.1	5.2 × 78.8 × 45.9	6.2 × 85 × 45.9			
Rated voltage		500 V	600 V				
Rated current *3		17.5 A	22 A	28 A			
IEC rated voltage		500 V					
IEC rated current *3		17.5 A/1.5 mm ²	22 A/2.5 mm ²	28 A/4.0 mm ²			
Usage Group (UG)		B, C	D	B, C			
UL rated voltage		300 V	51-150 V	151-300 V	301-600 V	600 V	
UL rated current *3		15 A/AWG14 (SOL), 10 A/AWG16	15 A/AWG14 (SOL), 10 A/AWG16	10 A/AWG16	5 A/AWG16-20	20 A/AWG12 (SOL), 15 A/AWG14	30 A/AWG10 (SOL), 20 A/AWG12
Dielectric strength		1,890 VAC for 1 min (leakage current: 1 mA max.)			2,000 VAC for 1 min (leakage current: 1 mA max.)		
End Cover		XW5E-P1.5-1.1-2	XW5E-P2.5-1.1-2	XW5E-P4.0-1.1-2			
Special tool		XW4Z-00B					
Applicable nameplates		XW5Z-P1.5LB2	XW5Z-P2.5LB□ or commercially available nameplate with 9.5 mm width and 0.5 mm thickness	XW5Z-P4.0LB□ or commercially available nameplate with 9.5 mm width and 0.5 mm thickness			
Applicable Short Bars		XW5S-P1.5-□ (□: Poles = 2, 3, 4, 5 or 10)	XW5S-P2.5-□ (□: Poles = 2, 3, 4, 5 or 10)	XW5S-P4.0-□ (□: Poles = 2, 3, 4, 5 or 10)			

*1. For the recommended applicable wire ranges, refer to page 17 for solid and stranded wires, and to page 19 for ferrules.

*2. You can also use ferrules for 1.0 to 1.5 mm² wires if you use ferrules without insulation sleeve. Refer to page 19 for details.

*3. Do not apply more than the rated current to the terminal block.

Feed Through Terminal blocks Multi conductor terminals

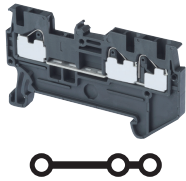
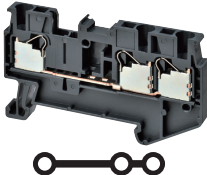
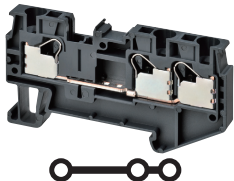
Model		XW5T-P1.5-1.2-1 (BL)				XW5T-P2.5-1.2-1 (BL)				XW5T-P4.0-1.2-1 (BL)			
Appearance and internal wiring		1 tier, 1:2				1 tier, 1:2				1 tier, 1:2			
													
Applicable wire sizes*1	Stranded wire	0.08 mm ² to 1.5 mm ²				0.14 mm ² to 2.5 mm ²				0.2 mm ² to 4.0 mm ²			
	Solid wire	0.14 mm ² to 1.5 mm ²				0.14 mm ² to 4.0 mm ²				0.2 mm ² to 6.0 mm ²			
	Stranded wire with ferrule with Plastic sleeve	0.14 mm ² to 0.75 mm ² (1.5 mm ²) *2				0.14 mm ² to 2.5 mm ²				0.25 mm ² to 4.0 mm ²			
Dimensions		3.5 × 54.1 × 30.5				5.2 × 60.5 × 35.3				6.2 × 66.5 × 35.3			
Rated voltage		500 V				800 V							
Rated current *3		17.5 A				24 A				32 A			
IEC rated voltage		500 V				800 V							
IEC rated current *3		17.5 A/1.5 mm ²				24 A/2.5 mm ²				32 A/4.0 mm ²			
Usage Group (UG)		B, C		D		B, C							
UL rated voltage		300 V	51-150 V	151-300 V	301-600 V	600 V							
UL rated current *3		15 A/AWG14 (SOL) 10 A/AWG16	15 A/AWG14 (SOL) 10 A/AWG16	10 A/AWG16	5 A/AWG16-20	20 A/AWG12 (SOL), 15 A/AWG14				30 A/AWG10 (SOL), 20 A/AWG12			
Dielectric strength		1,890 VAC for 1 min (leakage current: 1 mA max.)				2,000 VAC for 1 min (leakage current: 1 mA max.)							
End Cover		XW5E-P1.5-1.2-1				XW5E-P2.5-1.2-1				XW5E-P4.0-1.2-1			
Special tool		XW4Z-00B											
Applicable nameplates		XW5Z-P1.5LB□ or commercially available nameplate with 9.5 mm width and 0.5 mm thickness				XW5Z-P2.5LB□ or commercially available nameplate with 9.5 mm width and 0.5 mm thickness				XW5Z-P4.0LB□ or commercially available nameplate with 9.5 mm width and 0.5 mm thickness			
Applicable Short Bars		XW5S-P1.5-□ (□: Poles = 2, 3, 4, 5 or 10)				XW5S-P2.5-□ (□: Poles = 2, 3, 4, 5 or 10)				XW5S-P4.0-□ (□: Poles = 2, 3, 4, 5 or 10)			

*1. For the recommended applicable wire ranges, refer to page 17 for solid and stranded wires, and to page 19 for ferrules.

*2. You can also use ferrules for 1.0 to 1.5 mm² wires if you use ferrules without insulation sleeve. Refer to page 19 for details.

*3. Do not apply more than the rated current to the terminal block.

XW5T

Model		XW5T-P1.5-2.2-1 (BL)	XW5T-P2.5-2.2-1 (BL)	XW5T-P4.0-2.2-1 (BL)			
Appearance and internal wiring		1 tier, 2:2 	1 tier, 2:2 	1 tier, 2:2 			
Applicable wire sizes*1	Stranded wire	0.08 mm ² to 1.5 mm ²	0.14 mm ² to 2.5 mm ²	0.2 mm ² to 4.0 mm ²			
	Solid wire	0.14 mm ² to 1.5 mm ²	0.14 mm ² to 4.0 mm ²	0.2 mm ² to 6.0 mm ²			
	Stranded wire with ferrule with Plastic sleeve	0.14 mm ² to 0.75 mm ² (1.5 mm ²) *2	0.14 mm ² to 2.5 mm ²	0.25 mm ² to 4.0 mm ²			
Dimensions		3.5 × 63.2 × 30.5	5.2 × 72.2 × 35.3	6.2 × 76.9 × 35.3			
Rated voltage		500 V	800 V				
Rated current *3		17.5 A	24 A	32 A			
IEC rated voltage		500 V	800 V				
IEC rated current *3		17.5 A/1.5 mm ²	24 A/2.5 mm ²	32 A/4.0 mm ²			
Usage Group (UG)		B, C	D	B, C			
UL rated voltage		300 V	51-150 V	151-300 V	301-600 V	600 V	
UL rated current *3		15 A/AWG14 (SOL) 10 A/AWG16	15 A/AWG14 (SOL) 10 A/AWG16	10 A/AWG16	5 A/AWG16-20	20 A/AWG12 (SOL), 15 A/AWG14	30 A/AWG10 (SOL), 20 A/AWG12
Dielectric strength		1,890 VAC for 1 min (leakage current: 1 mA max.)			2,000 VAC for 1 min (leakage current: 1 mA max.)		
End Cover		XW5E-P1.5-2.2-1		XW5E-P2.5-2.2-1	XW5E-P4.0-2.2-1		
Special tool		XW4Z-00B					
Applicable nameplates		XW5Z-P1.5LB□ or commercially available nameplate with 9.5 mm width and 0.5 mm thickness		XW5Z-P2.5LB□ or commercially available nameplate with 9.5 mm width and 0.5 mm thickness		XW5Z-P4.0LB□ or commercially available nameplate with 9.5 mm width and 0.5 mm thickness	
Applicable Short Bars		XW5S-P1.5-□ (□: Poles = 2, 3, 4, 5 or 10)		XW5S-P2.5-□ (□: Poles = 2, 3, 4, 5 or 10)		XW5S-P4.0-□ (□: Poles = 2, 3, 4, 5 or 10)	

*1. For the recommended applicable wire ranges, refer to page 17 for solid and stranded wires, and to page 19 for ferrules.

*2. You can also use ferrules for 1.0 to 1.5 mm² wires if you use ferrules without insulation sleeve. Refer to page 19 for details.

*3. Do not apply more than the rated current to the terminal block.

Grounding Terminal blocks Standard terminals

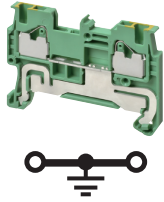
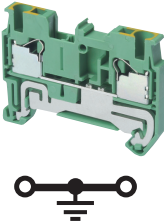
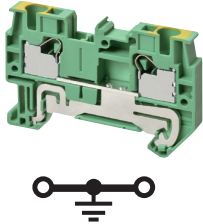
Model		XW5G-P1.5-1.1-1	XW5G-P2.5-1.1-1	XW5G-P4.0-1.1-1
Appearance and internal wiring		<p>1 tier, 1:1</p> 	<p>1 tier, 1:1</p> 	<p>1 tier, 1:1</p> 
Applicable wire sizes*1	Stranded wire	0.08 mm ² to 1.5 mm ²	0.14 mm ² to 2.5 mm ²	0.2 mm ² to 4.0 mm ²
	Solid wire	0.14 mm ² to 1.5 mm ²	0.14 mm ² to 4.0 mm ²	0.2 mm ² to 6.0 mm ²
	Stranded wire with ferrule with Plastic sleeve	0.14 mm ² to 0.75 mm ² (1.5 mm ²) *2	0.14 mm ² to 2.5 mm ²	0.25 mm ² to 4.0 mm ²
Dimensions		3.5 × 45 × 30.5	5.2 × 48.8 × 35.3	6.2 × 56.1 × 35.3
IEC rated voltage		500 V	800 V	
UL rated voltage		600 V		
Dielectric strength		1,890 VAC for 1 min (leakage current: 1 mA max.)	2,000 VAC for 1 min (leakage current: 1 mA max.)	
End Cover		XW5E-P1.5-1.1-1	XW5E-P2.5-1.1-1	XW5E-P4.0-1.1-1
Special tool		XW4Z-00B		
Applicable nameplates		XW5Z-P1.5LB□ or commercially available nameplate with 9.5 mm width and 0.5 mm thickness	XW5Z-P2.5LB□ or commercially available nameplate with 9.5 mm width and 0.5 mm thickness	XW5Z-P4.0LB□ or commercially available nameplate with 9.5 mm width and 0.5 mm thickness

Note: Use a conductive DIN Track when using a Grounding Terminal Block.

OMRON does not offer conductive DIN Tracks. Please use a commercially available product.

*1. For the recommended applicable wire ranges, refer to page 17 for solid and stranded wires, and to page 19 for ferrules.

*2. You can also use ferrules for 1.0 to 1.5 mm² wires if you use ferrules without insulation sleeve. Refer to page 19 for details.

Grounding Terminal blocks Multi tiers terminal

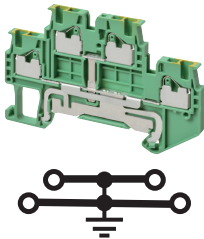
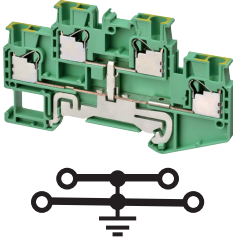
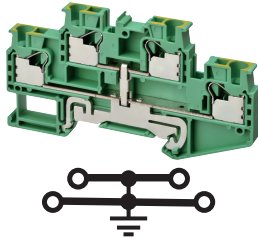
Model		XW5G-P1.5-1.1-2	XW5G-P2.5-1.1-2	XW5G-P4.0-1.1-2
Appearance and internal wiring		2 tiers, 1:1 	2 tiers, 1:1 	2 tiers, 1:1 
Applicable wire sizes*1	Stranded wire	0.08 mm ² to 1.5 mm ²	0.14 mm ² to 2.5 mm ²	0.2 mm ² to 4.0 mm ²
	Solid wire	0.14 mm ² to 1.5 mm ²	0.14 mm ² to 4.0 mm ²	0.2 mm ² to 6.0 mm ²
	Stranded wire with ferrule with Plastic sleeve	0.14 mm ² to 0.75 mm ² (1.5 mm ²) *2	0.14 mm ² to 2.5 mm ²	0.25 mm ² to 4.0 mm ²
Dimensions		3.5 × 65.7 × 41.1	5.2 × 78.8 × 45.9	6.2 × 85 × 45.9
IEC rated voltage		500 V		
UL rated voltage		600 V		
Dielectric strength		1,890 VAC for 1 min (leakage current: 1 mA max.)	2,000 VAC for 1 min (leakage current: 1 mA max.)	
End Cover		XW5E-P1.5-1.1-2	XW5E-P2.5-1.1-2	XW5E-P4.0-1.1-2
Special tool		XW4Z-00B		
Applicable nameplates		XW5Z-P1.5LB2	XW5Z-P2.5LB□ or commercially available nameplate with 9.5 mm width and 0.5 mm thickness	XW5Z-P4.0LB□ or commercially available nameplate with 9.5 mm width and 0.5 mm thickness

Note: Use a conductive DIN Track when using a Grounding Terminal Block.

OMRON does not offer conductive DIN Tracks. Please use a commercially available product.

*1. For the recommended applicable wire ranges, refer to page 17 for solid and stranded wires, and to page 19 for ferrules.

*2. You can also use ferrules for 1.0 to 1.5 mm² wires if you use ferrules without insulation sleeve. Refer to page 19 for details.

Grounding Terminal blocks Multi conductor terminals

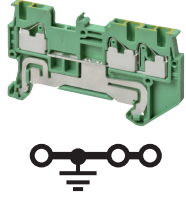
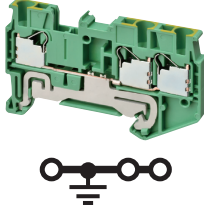
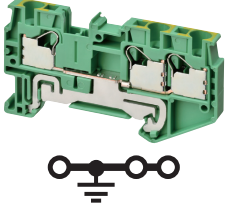
Model		XW5G-P1.5-1.2-1	XW5G-P2.5-1.2-1	XW5G-P4.0-1.2-1
Appearance and internal wiring		<p>1 tier, 1:2</p> 	<p>1 tier, 1:2</p> 	<p>1 tier, 1:2</p> 
Applicable wire sizes*1	Stranded wire	0.08 mm ² to 1.5 mm ²	0.14 mm ² to 2.5 mm ²	0.2 mm ² to 4.0 mm ²
	Solid wire	0.14 mm ² to 1.5 mm ²	0.14 mm ² to 4.0 mm ²	0.2 mm ² to 6.0 mm ²
	Stranded wire with ferrule with Plastic sleeve	0.14 mm ² to 0.75 mm ² (1.5 mm ²) *2	0.14 mm ² to 2.5 mm ²	0.25 mm ² to 4.0 mm ²
Dimensions		3.5 × 54.1 × 30.5	5.2 × 60.5 × 35.3	6.2 × 66.5 × 35.3
IEC rated voltage		500 V	800 V	
UL rated voltage		600 V	600 V	
Dielectric strength		1,890 VAC for 1 min (leakage current: 1 mA max.)	2,000 VAC for 1 min (leakage current: 1 mA max.)	
End Cover		XW5E-P1.5-1.2-1	XW5E-P2.5-1.2-1	XW5E-P4.0-1.2-1
Special tool		XW4Z-00B		
Applicable nameplates		XW5Z-P1.5LB□ or commercially available nameplate with 9.5 mm width and 0.5 mm thickness	XW5Z-P2.5LB□ or commercially available nameplate with 9.5 mm width and 0.5 mm thickness	XW5Z-P4.0LB□ or commercially available nameplate with 9.5 mm width and 0.5 mm thickness

Note: Use a conductive DIN Track when using a Grounding Terminal Block.

OMRON does not offer conductive DIN Tracks. Please use a commercially available product.

*1. For the recommended applicable wire ranges, refer to page 17 for solid and stranded wires, and to page 19 for ferrules.

*2. You can also use ferrules for 1.0 to 1.5 mm² wires if you use ferrules without insulation sleeve. Refer to page 19 for details.

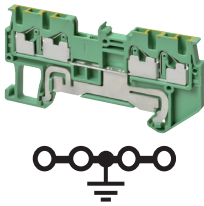
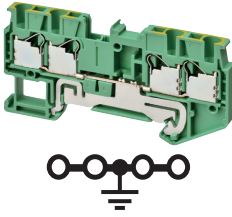
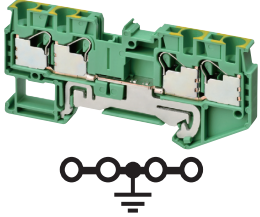
Model		XW5G-P1.5-2.2-1	XW5G-P2.5-2.2-1	XW5G-P4.0-2.2-1
Appearance and internal wiring		1 tier, 2:2 	1 tier, 2:2 	1 tier, 2:2 
Applicable wire sizes*1	Stranded wire	0.08 mm ² to 1.5 mm ²	0.14 mm ² to 2.5 mm ²	0.2 mm ² to 4.0 mm ²
	Solid wire	0.14 mm ² to 1.5 mm ²	0.14 mm ² to 4.0 mm ²	0.2 mm ² to 6.0 mm ²
	Stranded wire with ferrule with Plastic sleeve	0.14 mm ² to 0.75 mm ² (1.5 mm ²) *2	0.14 mm ² to 2.5 mm ²	0.25 mm ² to 4.0 mm ²
Dimensions		3.5 × 63.2 × 30.5	5.2 × 72.2 × 35.3	6.2 × 76.9 × 35.3
IEC rated voltage		500 V	800 V	
UL rated voltage		600 V		
Dielectric strength		1,890 VAC for 1 min (leakage current: 1 mA max.)	2,000 VAC for 1 min (leakage current: 1 mA max.)	
End Cover		XW5E-P1.5-2.2-1	XW5E-P2.5-2.2-1	XW5E-P4.0-2.2-1
Special tool		XW4Z-00B		
Applicable nameplates		XW5Z-P1.5LB□ or commercially available nameplate with 9.5 mm width and 0.5 mm thickness	XW5Z-P2.5LB□ or commercially available nameplate with 9.5 mm width and 0.5 mm thickness	XW5Z-P4.0LB□ or commercially available nameplate with 9.5 mm width and 0.5 mm thickness

Note: Use a conductive DIN Track when using a Grounding Terminal Block.

OMRON does not offer conductive DIN Tracks. Please use a commercially available product.

*1. For the recommended applicable wire ranges, refer to page 17 for solid and stranded wires, and to page 19 for ferrules.

*2. You can also use ferrules for 1.0 to 1.5 mm² wires if you use ferrules without insulation sleeve. Refer to page 19 for details.

Performance

Operating temperature	-40 to 55°C (with no condensation or icing)
Operating humidity	5% to 95%
Insulating material	PA resin
Fire resistance	UL94 V-0
Insertion durability	50 times
Vibration resistance	10 to 150 Hz, Acceleration of 50 m/s ² for 80 min each in X, Y, and Z directions
Shock resistance	500 m/s ² for 11 ms each in 6 directions 5 times
Storage Temperature Range	-40 to 85°C (with no condensation or icing)
Storage Humidity Range	5% to 95%

Short Bars

Model	XW5S-P1.5-□	XW5S-P2.5-□	XW5S-P4.0-□
Rated voltage	500 V	800 V	
Rated current	17.5 A	24 A	32 A

Standards

Compliant standard

- UL1059
- CSA (C22.2 No.158)
- IEC 60947-7-1

Certification

- cURus (File No. E245101)

Dimensions

DIN Track Terminal Blocks

XW5T-P1.5-1.1-1 (BL)/XW5G-P1.5-1.1-1

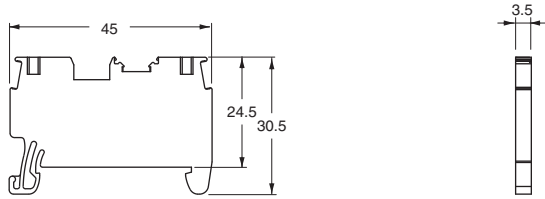

XW5T-P1.5-1.2-1 (BL)/XW5G-P1.5-1.2-1

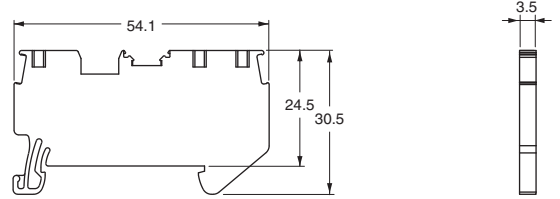

XW5T-P1.5-2.2-1 (BL)/XW5G-P1.5-2.2-1

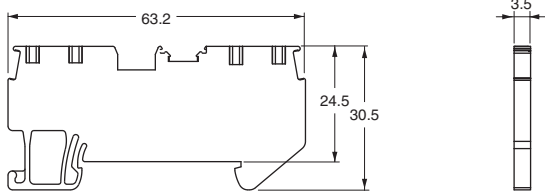

XW5T-P1.5-1.1-2 (BL)/XW5G-P1.5-1.1-2

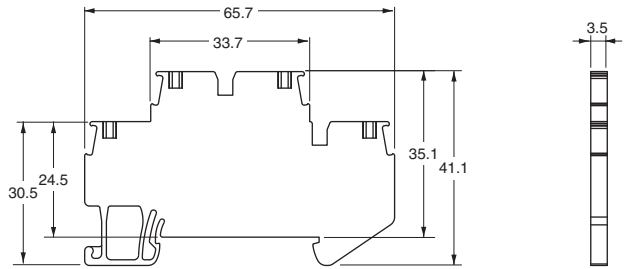

XW5T-P2.5-1.1-1 (BL)/XW5G-P2.5-1.1-1

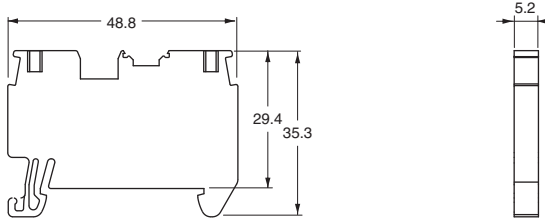

XW5T-P2.5-1.2-1 (BL)/XW5G-P2.5-1.2-1

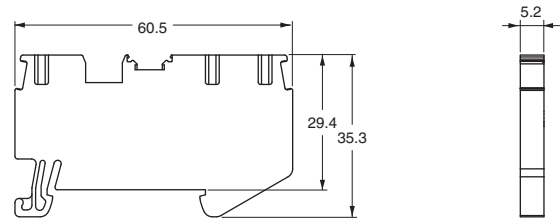

XW5T-P2.5-2.2-1 (BL)/XW5G-P2.5-2.2-1

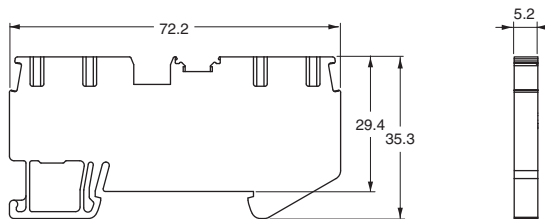

XW5T-P2.5-1.1-2 (BL)/XW5G-P2.5-1.1-2

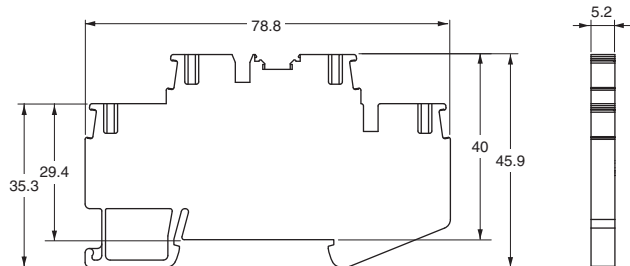

XW5T-P4.0-1.1-1 (BL)/XW5G-P4.0-1.1-1

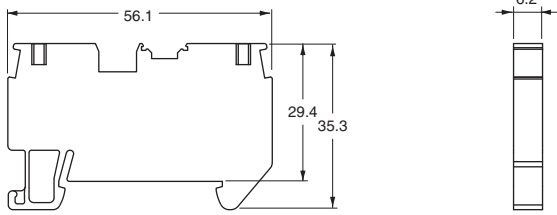

XW5T-P4.0-1.2-1 (BL)/XW5G-P4.0-1.2-1

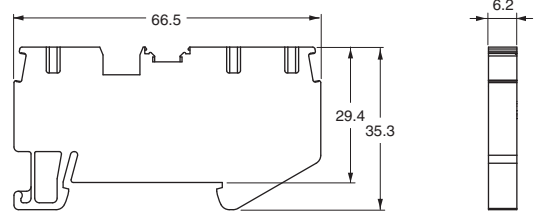

XW5T-P4.0-2.2-1 (BL)/XW5G-P4.0-2.2-1

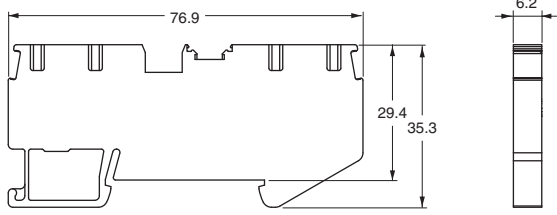

XW5T-P4.0-1.1-2 (BL)/XW5G-P4.0-1.1-2

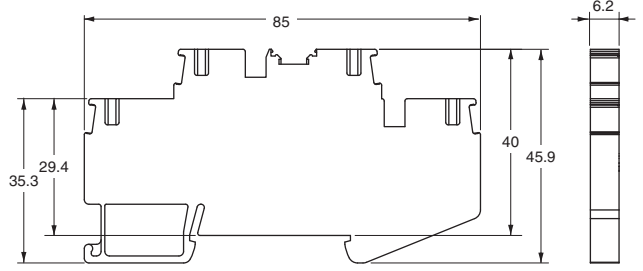

Short Bars

XW5S-P1.5-□

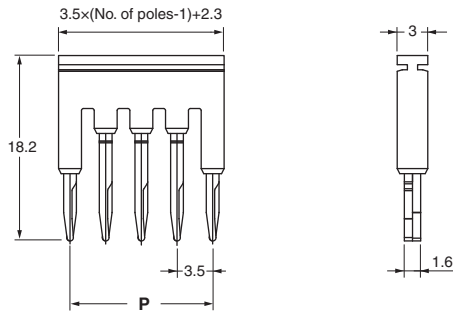

Model	P (mm)
XW5S-P1.5-2□	3.5
XW5S-P1.5-3□	7.0
XW5S-P1.5-4□	10.5
XW5S-P1.5-5□	14.0
XW5S-P1.5-10□	31.5

XW5S-P2.5-□

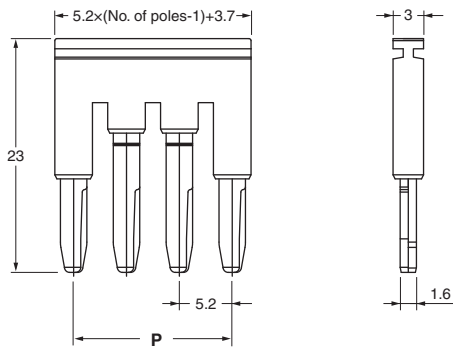

Model	P (mm)
XW5S-P2.5-2□	5.2
XW5S-P2.5-3□	10.4
XW5S-P2.5-4□	15.6
XW5S-P2.5-5□	20.8
XW5S-P2.5-10□	46.8

XW5S-P4.0-□

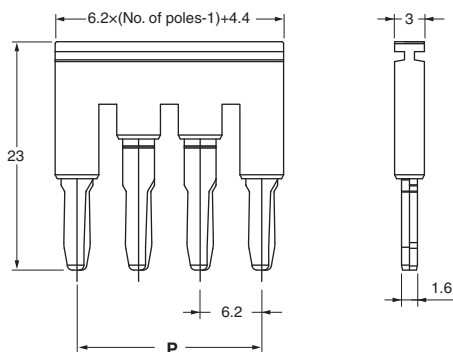

Model	P (mm)
XW5S-P4.0-2□	6.2
XW5S-P4.0-3□	12.4
XW5S-P4.0-4□	18.6
XW5S-P4.0-5□	24.8
XW5S-P4.0-10□	55.8

End Cover

XW5E-P1.5-1.1-1

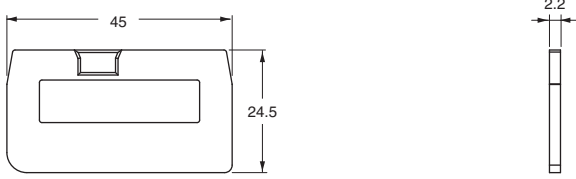

XW5E-P1.5-1.2-1

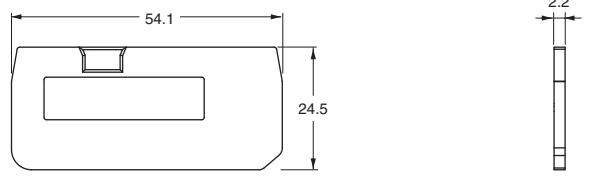

XW5E-P1.5-2.2-1

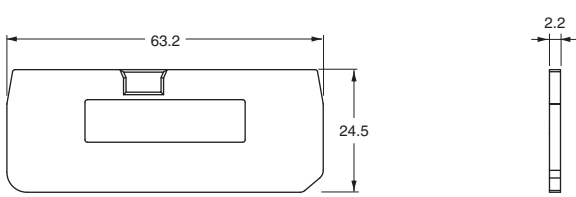

XW5E-P1.5-1.1-2

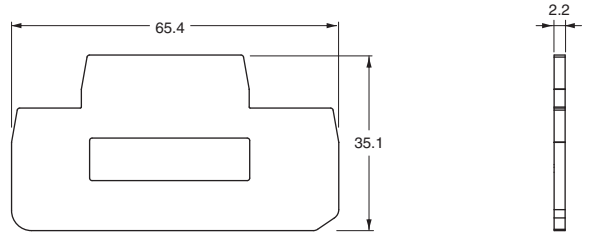

XW5E-P2.5-1.1-1

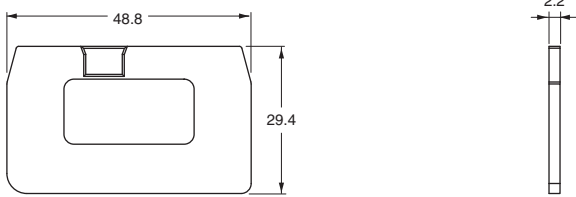

XW5E-P2.5-1.2-1

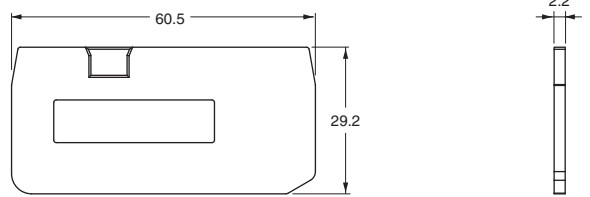

XW5E-P2.5-2.2-1

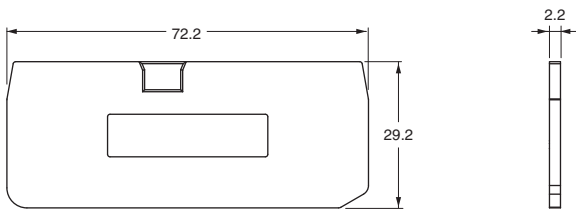

XW5E-P2.5-1.1-2

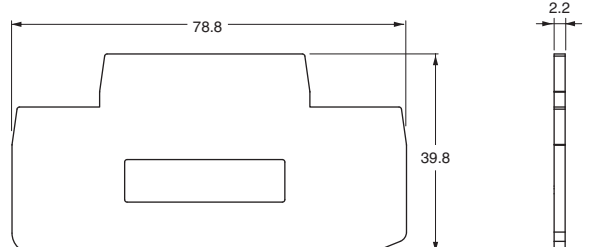

XW5E-P4.0-1.1-1

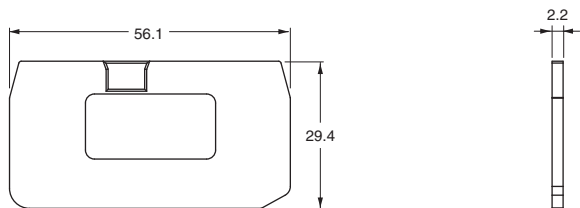

XW5E-P4.0-1.2-1

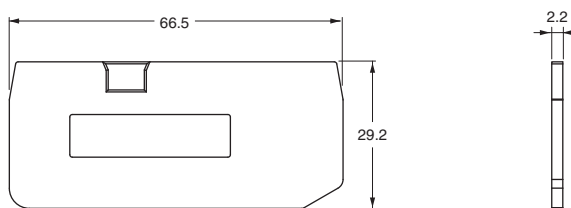

XW5E-P4.0-2.2-1

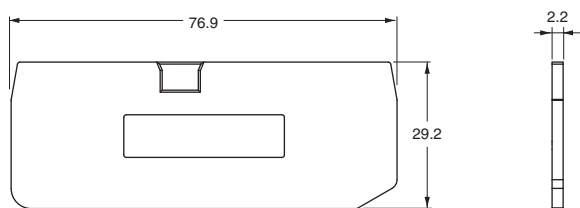

XW5E-P4.0-1.1-2

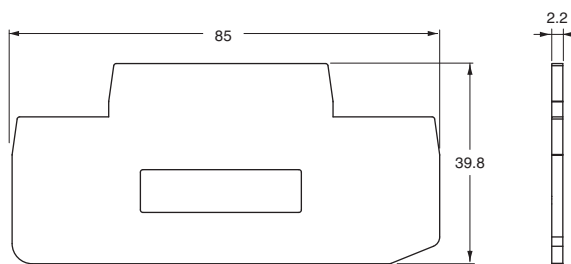

End Brackets/Separator Plates

XW5Z-EP6 (End Brackets)

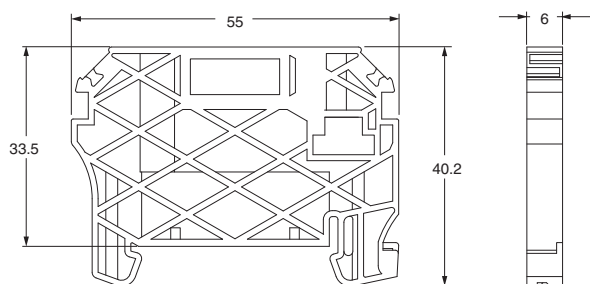

XW5Z-EP12 (Separator Plates)

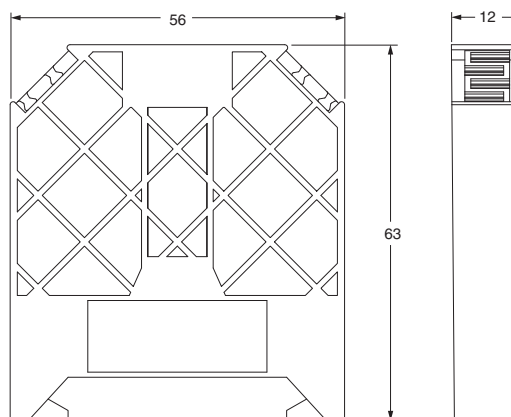

Safety Precautions

Warning Indications

Precautions for Safe Use	Supplementary comments on what to do or avoid doing, to use the product safely.
Precautions for Correct Use	Supplementary comments on what to do or avoid doing, to prevent failure to operate, malfunction, or undesirable effects on product performance.

Precautions for Safe Use

- Do not drop the Terminal Block. Terminal Block functionality may be inhibited.
- Do not exceed the ratings. Doing so may damage or burn out the Terminal Block.
- Mount the Terminal Blocks on a DIN Track and secure both ends with Stoppers.
- Do not use the Terminal Block in locations where toxic gases, such as H₂S, SO₂, NH₃, HNO₃, and Cl₂, may be present, or in locations subject to high temperature or humidity. Doing so may damage the Terminal Block due to contact failure or corrosion.
- Do not use the Terminal Block submerged in oil or water, or in locations continuously subject to splashes of oil or water. Doing so may result in oil or water entering and damaging the Terminal Block.
- Do not use or keep the Terminal Block under the following conditions:
 - Subject to severe temperature changes.
 - Subject to high humidity or condensation.
 - Subject to severe vibration or shock.
 - Where direct rays of the sun strike.
 - Where sea breeze may be present.
- Do not wire anything to the release holes.
- Do not tilt or twist a flat-blade screwdriver while it is inserted into a release hole on the terminal block. The terminal block may be damaged.
- Insert a flat-blade screwdriver into the release holes at an angle. The terminal block may be damaged if you insert the screwdriver straight in.
- Do not allow the flat-blade screwdriver to fall out while it is inserted into a release hole.
- Do not bend a wire past its natural bending radius or pull on it with excessive force. Doing so may cause the wire disconnection. Do not place excessive force on a Terminal Block. Doing so may damage or deform the Terminal Block and result in contact failure.
- Do not insert more than one wire into each terminal insertion hole.
- If you mount more than one Terminal Block, mount them so that the conductive parts of adjacent Terminal Blocks are facing in the same direction. If they face in different directions, short circuits may occur between adjacent Terminal Blocks.
- To prevent wire materials from smoking or igniting, confirm wire ratings and use the wiring materials given in the following table.

	Recommended Wire		Stripping length (Without Ferrules)
	Solid	Stranded	
XW5T-P1.5-□ XW5G-P1.5-□	0.14 to 1.5 mm ² / AWG 26 to 14	0.14 to 1.5 mm ² / AWG 28 to 16	8 mm
XW5T-P2.5-□ XW5G-P2.5-□	0.14 to 4.0 mm ² / AWG 26 to 12	0.14 to 2.5 mm ² / AWG 26 to 14	10 mm
XW5T-P4.0-□ XW5G-P4.0-□	0.25 to 6.0 mm ² / AWG 24 to 10	0.25 to 4.0 mm ² / AWG 24 to 12	12 mm

Precautions for Correct Use

1. Precautions for Correct Use

- Always mount End Covers to the following locations when you use Terminal Blocks.
 - Exposed metal surface of the last Terminal Block
 - Any Terminal Block that is next to a different shape of Terminal Block

There is a risk of electric shock if End Covers are not used.

- When you wire the Terminal Block, do not subject it or the wires to stress. Secure the wires so that they do not resonate with vibrations from the facilities in installation conditions.
- Always turn OFF the power supply before wiring. Electrical shock may occur.

2. Connecting Wires to the Push-In Plus Terminal Block

Part Names of the Terminal Block

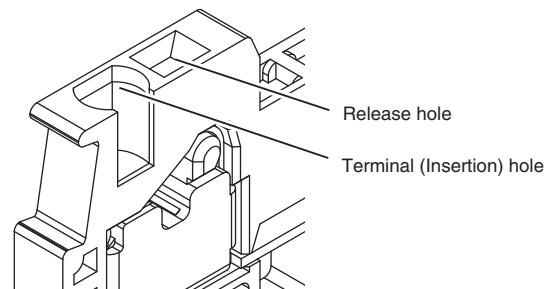

Connecting Wires with Ferrules and Solid Wires

Insert the solid wire or ferrule straight into the terminal block until the end strikes the terminal block.

If a wire is difficult to connect because it is too thin, use a flat-blade screwdriver in the same way as when connecting stranded wire.

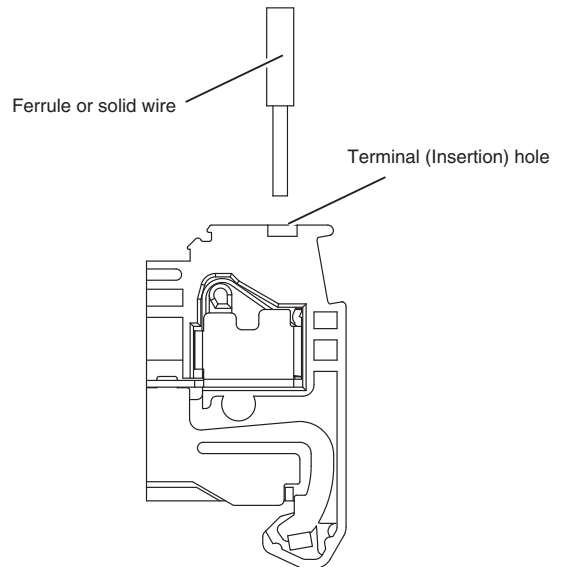

Connecting Stranded Wires

Use the following procedure to connect the wires to the terminal block.

1. Hold a flat-blade screwdriver at an angle and insert it into the release hole. The angle should be between 10° and 15°. If the flat-blade screwdriver is inserted correctly, you will feel the spring in the release hole.
2. With the flat-blade screwdriver still inserted into the release hole, insert the wire into the terminal hole until it strikes the terminal block.
3. Remove the flat-blade screwdriver from the release hole.

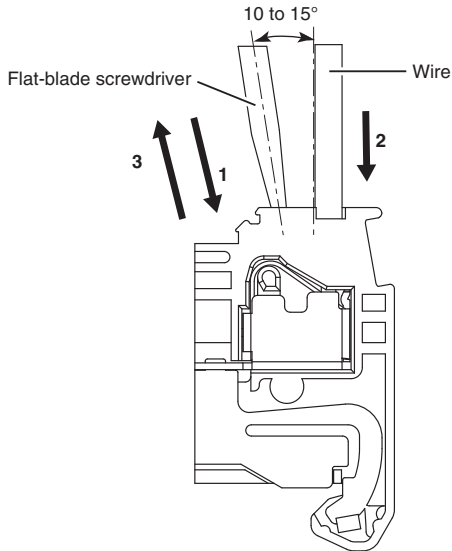

Checking Connections

- After the insertion, pull gently on the wire to make sure that it will not come off and the wire is securely fastened to the terminal block.
- If you use a ferrule with a conductor length of 10 mm, part of the conductor may be visible after the ferrule is inserted into the terminal block, but the product insulation distance will still be satisfied.

3. Removing Wires from the Push-In Plus Terminal Block

Use the following procedure to remove wires from the terminal block. The same method is used to remove stranded wires, solid wires, and ferrules.

1. Hold a flat-blade screwdriver at an angle and insert it into the release hole.
2. With the flat-blade screwdriver still inserted into the release hole, remove the wire from the terminal insertion hole.
3. Remove the flat-blade screwdriver from the release hole.

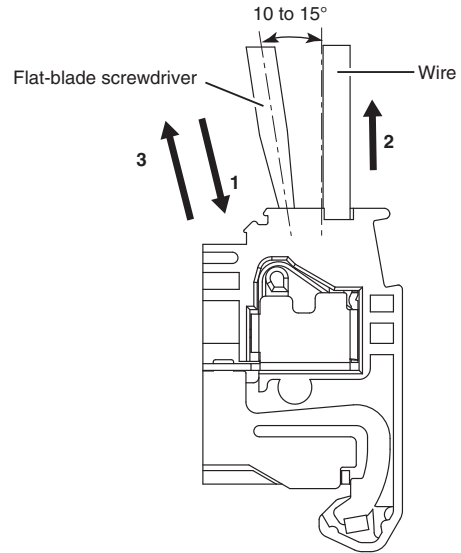

4. Recommended Ferrules and Crimp Tools

Recommended ferrules

XW5T-P1.5-□-□□/XW5G-□P1.5-□-□□

Applicable wire		Ferrule Conductor length (mm)	Stripping length (mm) (Ferrules used)	Recommended ferrules		
(mm ²)	(AWG)			Manufactured by Phoenix Contact	Manufactured by Weidmuller	Manufactured by Wago
0.14	26	8	10	Al 0,14-8	H0.14/12	---
0.25	24	8	10	Al 0,25-8	H0.25/12	216-301
		10	12	Al 0,25-10	---	---
0.34	22	8	10	Al 0,34-8	H0.34/12	216-302
		10	12	Al 0,34-10	---	---
0.50	20	8	10	Al 0,5-8	H0.5/14	216-201
		10	12	Al 0,5-10	H0.5/16	216-241
0.75	18	8	10	Al 0,75-8	H0.75/14	216-202
		10	12	Al 0,75-10	H0.75/16	216-242
Recommended crimp tool				CRIMPFOX6 CRIMPFOX6T-F CRIMPFOX10S	PZ6 roto	Variocrimp4

- Note:** 1. Make sure that the outer diameter of the wire is smaller than the inner diameter of the insulation sleeve of the recommended ferrule.
 2. Make sure that the ferrule processing dimensions conform to the following figure.

Ferrule Processed Dimensions

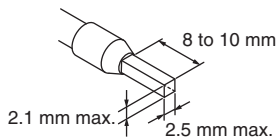

3. For the ferrule which is for applicable wire (1 to 1.5 mm²/ AWG 18 to 16), please use a ferrule without an insulation sleeve. (Refer to the following table.)

Applicable wire		Ferrule Conductor length (mm)	Stripping length (mm) (Ferrules used)	Recommended ferrules		
(mm ²)	(AWG)			Manufactured by Phoenix Contact	Manufactured by Weidmuller	Manufactured by Wago
1/1.25	18/17	8	8	A 1-8	---	F-1.0-8
		10	10	A 1-10	H1,0/10	F-1.0-10
1.25/1.5	17/16	10	10	A 1,5-10	H1,5/10	F-1.5-10
Recommended crimp tools				CRIMPFOX6 CRIMPFOX6T-F CRIMPFOX10S	PZ6 roto	Variocrimp4

XW5T-P2.5-□-□□/XW5G-□P2.5-□-□□

Applicable wire		Ferrule Conductor length (mm)	Stripping length (mm) (Ferrules used)	Recommended ferrules		
(mm ²)	(AWG)			Manufactured by Phoenix Contact	Manufactured by Weidmuller	Manufactured by Wago
0.14	26	8	10	Al 0,14-8	H0.14/12	---
0.25	24	8	10	Al 0,25-8	H0.25/12	216-301
		10	12	Al 0,25-10	---	---
0.34	22	8	10	Al 0,34-8	H0.34/12	216-302
		10	12	Al 0,34-10	---	---
0.50	20	8	10	Al 0,5-8	H0.5/14	216-201
		10	12	Al 0,5-10	H0.5/16	216-241
0.75	18	8	10	Al 0,75-8	H0.75/14	216-202
		10	12	Al 0,75-10	H0.75/16	216-242
1/1.25	18/17	8	10	Al 1-8	H1.0/14	216-203
		10	12	Al 1-10	H1.0/16	216-243
1.25/1.5	17/16	8	10	Al 1,5-8	H1.5/14	216-204
		10	12	Al 1,5-10	H1.5/16	216-244
2.5	14	10	12	Al 2,5-10	H2.5/16DS	216-246
Recommended crimp tool				CRIMPFOX6 CRIMPFOX6T-F CRIMPFOX10S	PZ6 roto	Variocrimp4

- Note:** 1. Make sure that the outer diameter of the wire is smaller than the inner diameter of the insulation sleeve of the recommended ferrule.
 2. Make sure that the ferrule processing dimensions conform to the following figure.

Ferrule Processed Dimensions

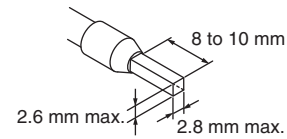

XW5T-P4.0-□-□□/XW5G-□P4.0-□-□□

Applicable wire		Ferrule Conductor length (mm)	Stripping length (mm) (Ferrules used)	Recommended ferrules				
(mm ²)	(AWG)			Manufactured by Phoenix Contact	Manufactured by Weidmuller	Manufactured by Wago		
0.25	24	12	14	Al 0,25-12	---	---		
0.34	22			Al 0,34-12	---	---		
0.50	20			Al 0,5-12	---	216-261		
0.75	18			Al 0,75-12	H0.75/18	216-262		
1/1.25	18/17			Al 1-12	H1.0/18	216-263		
1.25/1.5	17/16			Al 1,5-12	H1.5/18D	216-264		
2.5	14			Al 2,5-12	H2.5/19D	216-266		
4	12			Al 4-12	H4.0/20D	216-267		
Recommended crimp tool				CRIMPFOX6 CRIMPFOX6T-F CRIMPFOX10S	PZ6 roto	Variocrimp4		

- Note:** 1. Make sure that the outer diameter of the wire is smaller than the inner diameter of the insulation sleeve of the recommended ferrule.
 2. Make sure that the ferrule processing dimensions conform to the following figure.

Ferrule Processed Dimensions

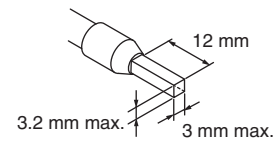

Recommended Flat-blade Screwdriver

Use a flat-blade screwdriver to connect and remove wires. Use the following flat-blade screwdriver.

The following table shows manufacturers and models as of 2015/Dec.

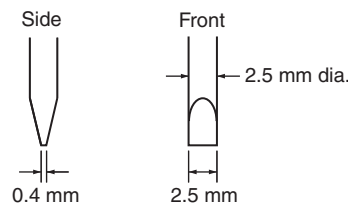

Model	Manufacturer
ESD 0,40x2,5	Wera
SZS 0,4x2,5 SZF 0-0,4x2,5*	Phoenix Contact
0.4x2.5x75 302	Wiha
AEF.2,5x75	Facom
210-719	Wago
SDIS 0.4x2.5x75	Weidmuller
9900 (-2.5x75)	Vessel

* OMRON's exclusive purchase model XW4Z-00B is available to order as SZF 0-0,4x2,5 (manufactured by Phoenix Contact).

Equivalent Labels from Other Companies and Recommended Label Printers

Use the following label printer.

The following table gives the manufacturer's model number as of March 2017.

Manufacturer	Omron	Phoenix Contact	Weidmuller	Cembre
Label	XW5Z-P1.5LB1	UCT-TM3,5	NA	MG-CPM-04 41392
	XW5Z-P2.5LB1	UCT-TM5	MF 8/5	MG-CPM-04 41390N
			MF 10/5	
			MF 12/5	
	XW5Z-P4.0LB1	UCT-TM6	MF 10/6	MG-CPM-04 41391
	XW5Z-P1.5LB2	UCT-TMF3,5	---	---
XW5Z-P2.5LB2	UCT-TMF5	---	---	
XW5Z-P4.0LB2	UCT-TMF6	---	---	
Label printer	--- *	BLUEMARK CLED, THERMOMARK CARD SET PLUS, THERMOMARK CARD	PrintJet ADVANCED, Plotter MCP Plus, Plotter MCP Basic	Markingenius MG3

* When using a printing tool, use a Phoenix Contact label printer.

Note: Ask the label manufacturer or printer manufacturer for details.

5. Mounting to DIN Track/Removing from DIN Track

Mounting Method

To mount a Terminal Block to a DIN Track, press it against the DIN Track as shown in the following figure.

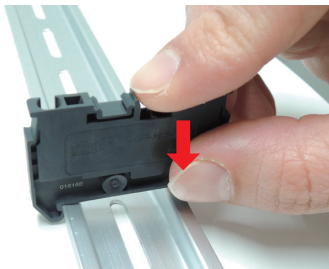

Removal Method

To remove a Terminal Block from the DIN Track, catch the tip of a screwdriver in the hook, operate the screwdriver so that the tip moves in direction (1), and then remove the Terminal Block in direction (2). However, do not apply excessive force to the Terminal Block. Doing so may damage it.

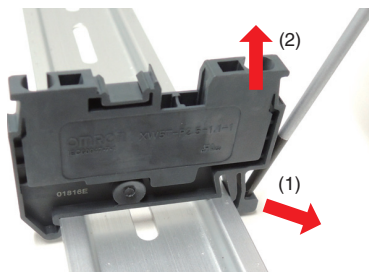

6. Using the Accessories

Short Bars

Mounting Method



1. Insert the Short Bar into the Short Bar holes.
2. Press the Short Bar in all of the way.

Removal Method

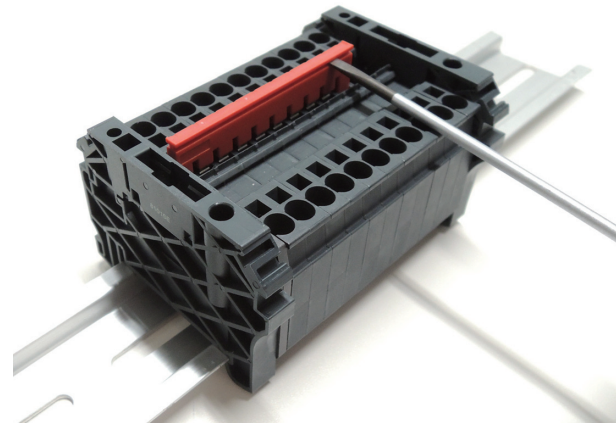

1. Insert the tip of a flat-blade screwdriver into the groove on the Short Bar and lift it up.
2. Remove the Short Bar.

Installation

You can bend and cut off any of the middle pins with a tool when you use a Short Bar.

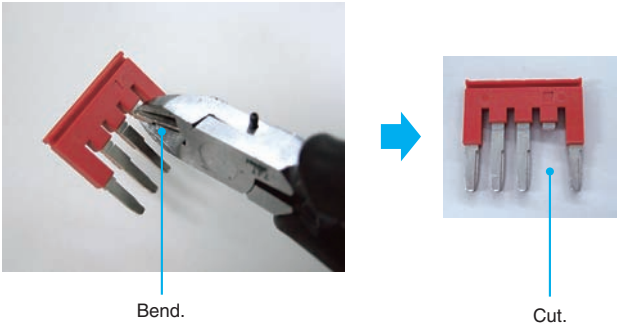

If a Short Bar that has the required pins is not available, you can combine more than one Short Bar to short the required Terminal Blocks. For example, the following figure shows combining Four-pin and Five-pin Short Bars to short eight Terminal Blocks.

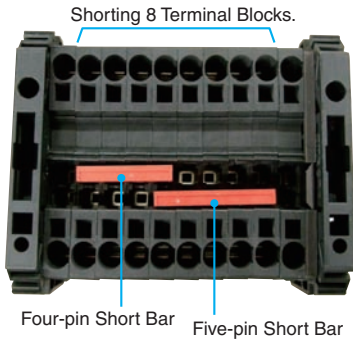

Labels

Mounting Method

Top-surface Labels



1. Remove the Labels one at a time.
 2. Insert them on the tops of the Terminal Blocks.
- Note:** If multiple Terminal Blocks of the same type are used side by side, you can use multiple Labels still connected to each other.

Side-surface Labels

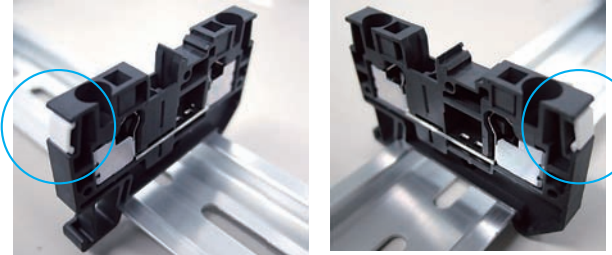
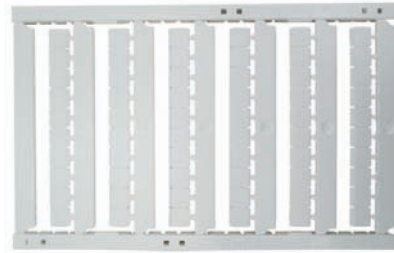

1. Remove the Labels one at a time.
 2. Insert them on the sides of the Terminal Blocks.
- Note:** 1. There is no place to mount the Top-surface Labels on Two-tier Terminal Blocks with a width of 3.5 mm, so they cannot be used.
2. Different models of Labels are used for the top and side surfaces.
3. If multiple Terminal Blocks of the same type are used side by side, you can use multiple Labels still connected to each other.

End Cover

Mounting Method

Attach the End Cover to the side of the Terminal Block with exposed metal.

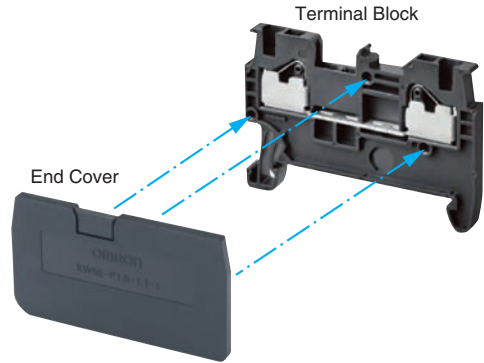

- Always mount End Covers to the following locations when you use Terminal Blocks.
- (1) Exposed metal surface of the last Terminal Block
 - (2) Any Terminal Block that is next to a different shape of Terminal Block
- There is a risk of electric shock if End Covers are not used.

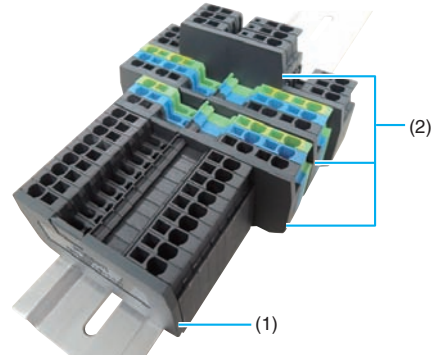

Note: End Brackets or Separator Plate cannot be used in place of an End Cover.

End Brackets

Mounting Method

The mounting and removal methods for DIN Track are the same as those for the Terminal Blocks.

Separator Plate

Mounting Method

Use a flat-blade screwdriver to tighten the screw in the middle of the top surface to mount the Separator Plate.

Loosen the screw to remove the Separator Plate from the DIN Track.

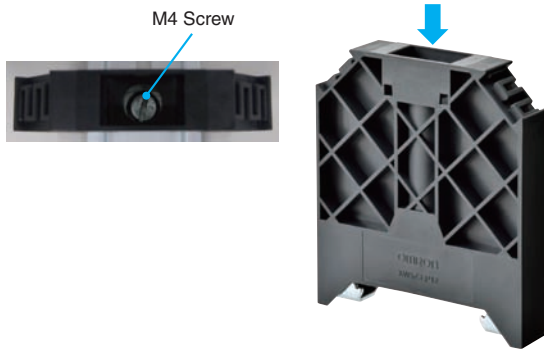

7. Storage

Storage Temperature Range

-40 to 85°C with no condensation or icing

Storage Humidity Range

5% to 95%

Terms and Conditions Agreement

Read and understand this catalog.

Please read and understand this catalog before purchasing the products. Please consult your OMRON representative if you have any questions or comments.

Warranties.

- (a) Exclusive Warranty. Omron's exclusive warranty is that the Products will be free from defects in materials and workmanship for a period of twelve months from the date of sale by Omron (or such other period expressed in writing by Omron). Omron disclaims all other warranties, express or implied.
- (b) Limitations. OMRON MAKES NO WARRANTY OR REPRESENTATION, EXPRESS OR IMPLIED, ABOUT NON-INFRINGEMENT, MERCHANTABILITY OR FITNESS FOR A PARTICULAR PURPOSE OF THE PRODUCTS. BUYER ACKNOWLEDGES THAT IT ALONE HAS DETERMINED THAT THE PRODUCTS WILL SUITABLY MEET THE REQUIREMENTS OF THEIR INTENDED USE.

Omron further disclaims all warranties and responsibility of any type for claims or expenses based on infringement by the Products or otherwise of any intellectual property right. (c) Buyer Remedy. Omron's sole obligation hereunder shall be, at Omron's election, to (i) replace (in the form originally shipped with Buyer responsible for labor charges for removal or replacement thereof) the non-complying Product, (ii) repair the non-complying Product, or (iii) repay or credit Buyer an amount equal to the purchase price of the non-complying Product; provided that in no event shall Omron be responsible for warranty, repair, indemnity or any other claims or expenses regarding the Products unless Omron's analysis confirms that the Products were properly handled, stored, installed and maintained and not subject to contamination, abuse, misuse or inappropriate modification. Return of any Products by Buyer must be approved in writing by Omron before shipment. Omron Companies shall not be liable for the suitability or unsuitability or the results from the use of Products in combination with any electrical or electronic components, circuits, system assemblies or any other materials or substances or environments. Any advice, recommendations or information given orally or in writing, are not to be construed as an amendment or addition to the above warranty.

See <http://www.omron.com/global/> or contact your Omron representative for published information.

Limitation on Liability; Etc.

OMRON COMPANIES SHALL NOT BE LIABLE FOR SPECIAL, INDIRECT, INCIDENTAL, OR CONSEQUENTIAL DAMAGES, LOSS OF PROFITS OR PRODUCTION OR COMMERCIAL LOSS IN ANY WAY CONNECTED WITH THE PRODUCTS, WHETHER SUCH CLAIM IS BASED IN CONTRACT, WARRANTY, NEGLIGENCE OR STRICT LIABILITY.

Further, in no event shall liability of Omron Companies exceed the individual price of the Product on which liability is asserted.

Suitability of Use.

Omron Companies shall not be responsible for conformity with any standards, codes or regulations which apply to the combination of the Product in the Buyer's application or use of the Product. At Buyer's request, Omron will provide applicable third party certification documents identifying ratings and limitations of use which apply to the Product. This information by itself is not sufficient for a complete determination of the suitability of the Product in combination with the end product, machine, system, or other application or use. Buyer shall be solely responsible for determining appropriateness of the particular Product with respect to Buyer's application, product or system. Buyer shall take application responsibility in all cases.

NEVER USE THE PRODUCT FOR AN APPLICATION INVOLVING SERIOUS RISK TO LIFE OR PROPERTY OR IN LARGE QUANTITIES WITHOUT ENSURING THAT THE SYSTEM AS A WHOLE HAS BEEN DESIGNED TO ADDRESS THE RISKS, AND THAT THE OMRON PRODUCT(S) IS PROPERLY RATED AND INSTALLED FOR THE INTENDED USE WITHIN THE OVERALL EQUIPMENT OR SYSTEM.

Programmable Products.

Omron Companies shall not be responsible for the user's programming of a programmable Product, or any consequence thereof.

Performance Data.

Data presented in Omron Company websites, catalogs and other materials is provided as a guide for the user in determining suitability and does not constitute a warranty. It may represent the result of Omron's test conditions, and the user must correlate it to actual application requirements. Actual performance is subject to the Omron's Warranty and Limitations of Liability.

Change in Specifications.

Product specifications and accessories may be changed at any time based on improvements and other reasons. It is our practice to change part numbers when published ratings or features are changed, or when significant construction changes are made. However, some specifications of the Product may be changed without any notice. When in doubt, special part numbers may be assigned to fix or establish key specifications for your application. Please consult with your Omron's representative at any time to confirm actual specifications of purchased Product.

Errors and Omissions.

Information presented by Omron Companies has been checked and is believed to be accurate; however, no responsibility is assumed for clerical, typographical or proofreading errors or omissions.

OMRON Corporation Industrial Automation Company
Kyoto, JAPAN

Contact: www.ia.omron.com

Regional Headquarters

OMRON EUROPE B.V.

Wegalaan 67-69, 2132 JD Hoofddorp
The Netherlands

Tel: (31)2356-81-300/Fax: (31)2356-81-388

OMRON ELECTRONICS LLC

2895 Greenspoint Parkway, Suite 200
Hoffman Estates, IL 60169 U.S.A.

Tel: (1) 847-843-7900/Fax: (1) 847-843-7787

OMRON ASIA PACIFIC PTE. LTD.

No. 438A Alexandra Road # 05-05/08 (Lobby 2),
Alexandra Technopark,
Singapore 119967

Tel: (65) 6835-3011/Fax: (65) 6835-2711

OMRON (CHINA) CO., LTD.

Room 2211, Bank of China Tower,
200 Yin Cheng Zhong Road,
PuDong New Area, Shanghai, 200120, China

Tel: (86) 21-5037-2222/Fax: (86) 21-5037-2200

Authorized Distributor:

© OMRON Corporation 2016-2020 All Rights Reserved.
In the interest of product improvement,
specifications are subject to change without notice.

CSM_1_18

Cat. No. G124-E1-05

0720(0316)